

Domestic Mixed Plastics Packaging Waste Management Options



An assessment of the technical, environmental and economic viability of recycling domestic mixed plastics packaging waste in the UK.

WRAP helps individuals, businesses and Local Authorities to reduce waste and recycle more, making better use of resources and helping to tackle climate change.

Written by: Stuart Foster



Front cover photography: Mixed plastics © WRAP

WRAP and Recoup believe the content of this report to be correct as at the date of writing. However, factors such as prices, levels of recycled content and regulatory requirements are subject to change and users of the report should check with their suppliers to confirm the current situation. In addition, care should be taken in using any of the cost information provided as it is based upon numerous project-specific assumptions (such as scale, location, tender context, etc.). The report does not claim to be exhaustive, nor does it claim to cover all relevant products and specifications available on the market. While steps have been taken to ensure accuracy, WRAP cannot accept responsibility or be held liable to any person for any loss or damage arising out of or in connection with this information being inaccurate, incomplete or misleading. It is the responsibility of the potential user of a material or product to consult with the supplier or manufacturer and ascertain whether a particular product will satisfy their specific requirements. The listing or featuring of a particular product or company does not constitute an endorsement by WRAP and WRAP cannot guarantee the performance of individual products or materials. This material is copyrighted. It may be reproduced free of charge subject to the material being accurate and not used in a misleading context. The source of the material must be identified and the copyright status acknowledged. This material must not be used to endorse or used to suggest WRAP's endorsement of a commercial product or service. For more detail, please refer to WRAP's Terms & Conditions on its web site: www.wrap.org.uk

Executive Summary

Project background and aims

Mixed plastics is a term that covers all non-bottle plastic packaging sourced from the domestic waste stream and includes rigid and flexible plastic items of various polymer types and colours that are typically found in the household waste bin. It excludes plastic bottles and non-packaging items.

There is approximately 1 million tonnes of domestic mixed plastics packaging waste arising in the UK each year¹ and this tonnage is growing. With an increasing range of materials being recovered in domestic waste recycling systems, mixed plastics packaging is one of the most visible remaining components of the domestic waste bin.

There is a need to develop sustainable waste management options for non-bottle mixed plastics packaging. A number of Local Authorities are already accepting a wider range of plastics in their domestic recycling systems although the end markets are under developed in the UK.

The aim of this project was to assess the feasibility of recycling domestic mixed plastics packaging through an appraisal of available recycling technologies, related financial implications and environmental benchmarking. Process designs were developed to determine if mixed plastics packaging can be recycled to a market specification in a financially and environmentally sustainable way. As part of the environmental benchmarking, these process designs were compared to alternative waste management options.

Input raw material

This project used mixed plastics packaging from the domestic waste stream. This included rigid and flexible plastics packaging items of all polymer types and colours that are typically found in the household. The trial material was sourced from operational sorting facilities from which the majority of bottles and other recyclables had been removed. This feedstock still included some contamination from non-packaging plastics and other residual materials. The proposed process designs in this study were based on handling a generic mix of the input material of composition shown in the table below.

Figure 1 Example of mixed plastics packaging (based on project and background data)



Table 1 Generic composition of UK domestic mixed plastics packaging material

Polymer Type		Generic Composition (%)
Flexible	PE	25%
	PP	5%
Rigid	PP	17.2%
	PE	13.5%
	PET	15.3%
	PVC	3.5%
	PS	4%
Contamination		16.5%
Total		100%

Technology trial results

Four key types of mixed plastics packaging recycling technology were identified and trialled. These included;

- Film separation (sorting flexible plastics packaging from whole rigid items).
- Whole item separation (sorting whole rigid items by polymer or colour).

¹ Based on DEFRA 2006 plastic packaging waste arising data (2,079,865t) and Waste Strategy For England 2007 Annex D6 paragraph 121 identifies 'within plastic packaging waste, about two-thirds of this is estimated to arise in the household waste stream and one-third in the C&I waste streams'.

- Flake dry cleaning (cleaning of flaked plastics packaging using friction cleaning).
- Flake separation (separation and washing of flaked plastics packaging by polymer or colour).

These were combined with other linking and output preparation equipment such as conveyor belts, balers, and extrusion and bagging lines to develop the process designs as shown in the diagram below.

Figure 2 Overview diagram for domestic mixed plastics packaging process designs

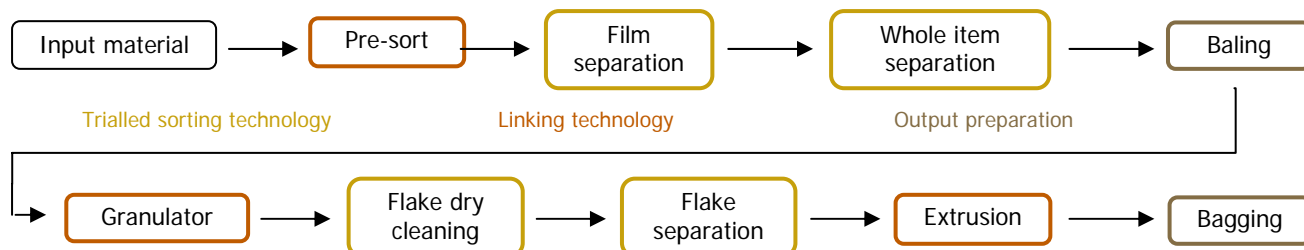

Film separation: Two technologies were tested for the removal of plastic film and other flat items from the rigid mixed plastics. The results of the trials demonstrated that both technologies were capable of achieving a high level of separation (figure 3 & 4). Separation of film from rigid packaging is an essential step as the significant presence of film in downstream technologies will affect their performance.

Figure 3 Sorted rigid fraction



Figure 4 Sorted film fraction



Whole item separation: A number of technologies are available for the polymer or colour separation of whole rigid plastics packaging items. The trialled systems demonstrated that individual polymers could be successfully identified and removed from a mixed plastics stream. Due to the similar performance observed a generic dataset was used for process design development (table 2).

Table 2 Output purity for whole item Near Infra Red (NIR) sorting

Polymer	PP	PE	PET	PS	PVC	PLA	Throughput
Purity Achieved*	96%	94%	94%	87%	93%	97%	3 tph

*Representative output purity for NIR Sorting

Flake dry cleaning: When the domestic mixed plastics packaging was flaked, a friction based dry-cleaning process was able to remove surface dirt and paper labels from the flake without the use of a water washing process. The dry-cleaner machine reduced the contamination in a rigid plastic flake sample from 22% to 3% after two material passes.

Flake separation: Density separation technologies were trialled to recover the polyolefin plastic flakes. This included technologies for colour separation which demonstrated high colour separation levels of 96% to 99% using 2 or 3 passes through the technology (figure 5 and table 3).

Figure 5 Cleaned polyolefin output fraction from density separation technology



Table 3 Output flake purity from density separation technology

Density Separation Technology	Polyolefin purity	Throughput (tph)
A	100%	1
B	99%	1.25
C	98%	1.3
D	100%	2
E	95%	4

Process designs and economic results

Process designs were developed from the various technologies for recycling mixed plastics packaging.

One of the preferred process designs incorporates the whole item sorting technologies with flake sorting and extrusion technologies. The outputs include whole baled PS and PVC, cleaned flaked PET and extruded PP, PE and film. A 40,000 tonnes/yr facility based on this process design would recover 67% or 27,000 tonnes of plastics packaging from the input stream for recycling which equates to ca. 41,000 tonnes of carbon dioxide savings². This facility incurs a capital cost of £15.4 million. The IRR ranges from ca. 10% to 30% depending on the raw material cost.

Preliminary financial modelling of the process designs highlighted a sensitivity to the value achieved for recovered output materials. An overview market assessment demonstrated maximum market value can be achieved by incorporating downstream processing such as extrusion. The results of the financial modelling must be interpreted with some caution due to potential sensitivities around key parameters such as output market values, electricity costs, and oil and virgin plastic prices.

Environmental lifecycle assessment and benchmarking of sorting technologies

The environmental Life Cycle Assessment (LCA) included benchmarking the environmental impacts of the recycling process designs evaluated in the study against alternative waste management options such as landfill, incineration (with or without energy recovery), Solid Recovered Fuel (SRF) for cement kilns and pyrolysis.

The key conclusion is that for Global Warming Potential (GWP), mechanical recycling is environmentally preferable. SRF for cement kilns also performed well and was shown to be better than the other alternative waste management options such as landfill or incineration.

The LCA also found that for most of the impact categories studied, landfill is less favourable than incineration of mixed plastics. However, for GWP this study has found that incineration (with or without energy recovery) is less favourable than landfill for domestic mixed plastics.

On the basis of these results we can conclude that it is environmentally beneficial to remove mixed plastic from the waste stream prior to either landfill or incineration. The diverted mixed plastics stream should be managed through a combination of mechanical recycling and SRF type processes.

Note that this LCA relates only to the waste management options for mixed plastics. An assessment of the potential effect of managing mixed plastics as part of a mixed municipal waste stream was outside of the scope of this study.

The environmental benefit (GWP) of recycling mixed plastics is underpinned by the substitution of virgin plastic by recycled plastic and associated avoided impacts of virgin plastic production. However, if the proportion of recycled plastic that can substitute directly for virgin plastic falls below a certain level, alternative waste management technologies may become more favourable. This assessment estimates that this level is approximately 70%. Hence the best environmental option requires a focus on developing facilities capable of producing high quality recycled plastics that can substitute for virgin plastics.

² Reference point : Environmental Benefits of Recycling; An international review of life cycle comparisons for key materials in the UK recycling sector, WRAP 2006 section 3.4.1 : Plastic Main Findings.

Conclusions

This study has shown that mechanical recycling of domestic non-bottle mixed plastics packaging is technically feasible, as well as environmentally and economically sustainable. Preliminary process designs have been identified.

The study has also identified that the key risks to the development of mixed plastics recycling in the UK are:

- Availability of input material at the right market quality and price.
- Demand and price for the output plastic streams.
- Development of a process design which is attractive to investment.

Contents

1.0	Introduction	9
2.0	Aims and Objectives	10
3.0	Project Partners	11
4.0	Current Domestic Mixed Plastic Waste Management	12
4.1	Mixed plastics waste collection systems	12
4.2	Mixed plastics within recyclables sorting systems	12
4.3	Mixed plastic sorting in Germany	13
4.4	Mixed plastics resource flows	14
4.4.1	Recycling	14
4.4.2	Incineration	14
4.4.3	Landfill	14
5.0	What is Domestic Mixed Plastics Packaging	16
5.1	Project definition of mixed plastics	16
5.2	Plastic waste stream characterisation	16
5.3	UK domestic packaging arisings	17
5.4	Plastic types and estimated composition of domestic mixed plastic packaging	17
6.0	Legislation and Drivers	21
6.1	Packaging waste regulations	21
6.2	Transfrontier shipment of waste regulations (1994)	22
6.3	Reach regulations (67/548/EEC)	22
6.4	PAS 103 plastic specifications	22
6.5	Product design	22
6.6	Non legislative drivers	23
7.0	Project Approach and Method	24
7.1	Trial technology selection	24
7.2	Supply of trial material	24
7.3	Operational trials	25
7.3.1	General approach	25
7.3.2	Whole item separation trials	25
7.3.3	Flake separation trials	26
7.4	Technology benchmarking	27
7.4.1	Financial benchmarking	27
7.4.2	Environmental benchmarking	27
7.5	Process designs	28
8.0	Mixed Plastic Packaging Recycling Trial Results	30
8.1	Separating flexible plastics from whole rigid items	30
8.2	Separating whole rigid items by polymer or colour	32
8.3	Separating flaked items by polymer or colour	36
8.3.1	Flake sorting by polymer	36
8.3.2	Flake sorting by colour	40
8.3.3	Dry cleaning of flake	43
9.0	Investment appraisal of Recycling Mixed Plastics Packaging	45
9.1	Investment appraisal approach	45
9.2	Plastic markets and values	46
10.0	Environmental Lifecycle Assessment and Benchmarking of Recycling Technologies	49
10.1	Introduction	49
10.2	Functional unit	49
10.3	Study boundaries	49
10.4	Impact assessment categories and relevant metrics	49
10.5	Allocation procedures	50
10.6	Results	51
11.0	Process Designs for the Sorting of Domestic Mixed Plastics Packaging	57
11.1	Considerations for process design development	57
11.1.1	Input material	57
11.1.2	How the sorting process fits together	57
11.1.3	Output market fractions	59

11.1.4	Priorities for the process designs.....	59
11.2	Recommended process designs	59
11.2.1	Process design A: film sorting and infrared sorting of whole items	59
11.2.2	Process design B: film sorting and infrared sorting of whole items followed by flake sorting and compounding.....	60
11.2.3	Process design C: whole film sorting and flake sorting.....	60
11.3	Process design review.....	64
11.3.1	Recycling levels achieved	64
11.3.2	Preliminary assessment of the economic viability of the process designs	64
11.3.3	Environmental benchmarking of process designs	68
11.4	Process design summary and additional considerations	70
12.0	Conclusions	72
12.1	Project conclusions	72
12.1.1	Process design conclusions	72
12.1.2	Technology trial conclusions	73
12.1.3	Recycling process financial conclusions.....	73
12.1.4	Environmental lifecycle assessment and benchmarking conclusions.....	73
12.1.5	Mixed plastics packaging trial material conclusions.....	74
12.2	Main risks affecting feasibility of sorting domestic mixed plastics packaging	75
12.3	Developing UK domestic mixed plastics packaging sorting infrastructure: potential areas of further research	75
	Glossary.....	77

1.0 Introduction

There is approximately 1 million tonnes of non-bottle domestic mixed plastic packaging waste arising in the UK each year³, and this is estimated to be increasing between 2% and 5% per annum⁴. This fraction contains rigid plastic containers including pots, tubs and trays, plus flexible plastics such as bags and films.

Plastics packaging makes up an average 9% of domestic waste by weight⁵ and represents a significant and disproportionately high capacity due to its low weight and high volume characteristics. An increasing range of materials are being recovered in comprehensive recycling systems leaving plastic packaging as one of the most visible remaining components of the household waste bin.

Recycling targets for all packaging materials have been revised with the plastic specific target now set at 26% for 2008⁶. Any post-use plastic packaging can contribute to this target which has led to a focus on the more cost effective and easily recoverable streams such as commercial and industrial rather than domestic packaging.

The recycling of plastic bottles from households has seen rapid growth in the past five years. Other packaging plastics are more varied in polymer type, application, contamination and physical form, making them harder to recycle. The perceived difficulty in efficient collection and sorting of mixed plastics packaging currently makes it a low value, low priority waste stream for many Local Authorities and waste management companies.

However, there are a number of policy, technology and economic drivers that make the collection of plastics packaging for recycling increasingly attractive; subject to the implementation of a sustainable collection and sorting infrastructure. Residual waste disposal costs are increasing each year, with landfill taxes scheduled to increase by £8 per year for the next three years. With average landfill gate fees of around £21 per tonne⁷ and a landfill tax charge of £32 per tonne,⁸ disposal costs currently stand at around £53 per tonne. Assuming no further gate fee revisions, the landfill disposal of domestic waste will cost almost £70 per tonne by April 2010.

Historically, the message from the plastics recycling industry has been to focus on collecting plastic bottles. There have also been a range of reported negative experiences from councils that have collected mixed plastics or being offered collections of mixed plastics that have not been successful or which have not 'delivered the promise'. The cost of mixed plastics recycling has traditionally been a barrier with some schemes in mainland Europe operating at significant net cost⁹. Project work previously undertaken in the UK has not translated into many new mixed plastics collection schemes due to the relatively high costs that have been identified.

While there are markets for all major polymer types once separated, there is an under developed market at the present time for a mixed plastics stream. Sorting and handling issues are a particular challenge for mixed plastics, as films and mixed rigid plastics are historically difficult to separate into marketable fractions.

There is a need to develop sustainable waste management options for non-bottle mixed plastics packaging. A combination of increasing awareness of recycling, and pressure from across the supply chain has forced many to reconsider their views, with a number of Local Authorities accepting a wider range of plastics in their domestic recycling systems.

³ Based on DEFRA 2006 plastic packaging waste arising data (2,079,865t) and Waste Strategy For England 2007 Annex D6 paragraph 121 identifies 'within plastic packaging waste, about two-thirds of this is estimated to arise in the household waste stream and one-third in the C&I waste streams'.

⁴ UK Plastics Waste – A review of supplies for recycling, global market demand, future trends and associated risks, WRAP, November 2006.

⁵ Indicative Recoup average based on available published household waste composition assessments.

⁶ DEFRA news article : <http://www.defra.gov.uk/news/2008/080211a.htm>

⁷ Source: WRAP Gate Fees Survey (2007) forthcoming publication. By comparison, the 2004 research project 'Study to Identify Methods of Enhancing Local Authority Collection of Plastics' indicated that current average disposal costs were £37.30 per tonne, including £14 landfill tax and £23.30 gate fee.

⁸ for the year starting 1st April 2008.

⁹ Collection costs of over £300 per tonne are reported, with additional feed preparation and feedstock gate fees exceeding £150/tonne.

2.0 Aims and Objectives

The primary aim of this study was to evaluate the technical, environmental and economic feasibility of recycling mixed plastics packaging in the UK.

This was achieved through the assessment of various plastics recycling technologies including an appraisal of separation performance levels, the capital and running costs of the technologies, and the environmental impacts associated with running those technologies.

Full mixed plastic packaging recycling processes were then developed through the linking of the most suitable technologies to determine if the mixed plastics can be sorted to a market specification in a financially and environmentally sustainable way, particularly when compared to alternative waste management options.

To achieve the project aims, the following approach was taken:

Background

- A summary desk-based review of available sorting technologies.
- An assessment and selection of technologies for practical trials.
- A review of mixed plastic sources.

Practical sorting trials

- A demonstration of the capability of each recycling technology for the recycling of a stream of mixed plastics packaging by polymer and/or colour.
- A measurement of the average purity of each sorted output fraction from the trials.
- A measurement of the average sorting efficiency from the trials.
- An investigation of whether the technology can be used to segregate two particular materials from the polymer mixture: bio-plastic trays (PLA material) and carton board.
- An investigation of the limitations of the technologies in relation to the type and format of plastics items presented during the trial.

Benchmarking

- A definition of the scope of capital equipment needed to carry out the sorting of mixed plastic packaging into the main polymer types.
- Establishment of the running and operating cost for full scale machinery.
- An environmental assessment (LCA) of the technologies within a commercial facility.
- Desk-based studies of alternative technologies to provide a comparative assessment of mixed plastics recycling vs. other available waste management options.

Mixed plastic recycling process development

- Development of sequential sorting processes to remove each of the main polymer types. This included – PET, PE, PP, PS, PVC.
- Links to required technologies using the most efficient and suitably available techniques.
- Modelling of the expected financial rate of return on capital for the recommended plant design.
- Comparison of the processes in the recommended plant design against alternative waste management options using environmental benchmarking.

3.0 Project Partners

A number of project partners have been involved in the delivery of this project as detailed below.

Table 4 Project partners involved

Project Function	Key Project Roles	Company	Staff / Contact
Project funder	Contract management, steering group.	WRAP	Gareth Boyles Paul Davidson Keith James
Contractor	Project management, delivery of final report, steering group.	Recoup	Stuart Foster John Simmons Ben Layton
Subcontractors	Trial material sourcing and transport.	RSL	Alison Rutterford
	Trial adjudication, financial assessment, process development, steering group.	PPS Ltd	Darren Furse, Steve Farnell, Ian Smith
	Environmental and financial assessment, benchmarking, process development, steering group.	Scott Wilson Ltd	David Smith Peter Shonfield Steven Pearce
	LCA advisor focussing on alternative waste management options, steering group.	Bowman Process Technology Ltd	Nick Takel
Peer reviewers	Steering group, European perspective.	Plastics Europe	Jan-Erik Johansson
	LCA review.	Tecpol	Hermann Kraehling
	LCA peer review (lead).	EMRC (on behalf of AEA Energy and Environment)	Mike Holland
	LCA peer review.	ERM	Bernie Thomas
	LCA peer review.	Boustead Consulting	Ian Boustead
Third party work packages	Trials management and reporting, market values review.	Axion Recycling	Keith Freegard
	Trials management and reporting.	Nextek	Ed Kosior Rob Dvorak

4.0 Current Domestic Mixed Plastic Waste Management

Some domestic mixed plastic packaging waste is already handled through UK waste management systems. Some of this is collected intentionally and some as a consequence of collecting plastic bottles. This section outlines the current collection and sorting of mixed plastic waste and an overview of the mixed plastic material flows through these systems.

4.1 Mixed plastics waste collection systems

Mixed plastics packaging waste is commonly collected from households as part of a weekly or fortnightly residual collection. However, this plastic will not always be recycled and may go with residual waste to landfill or incineration.

According to the WRAP Local Authorities Plastics Collection Survey 2008¹⁰ 92% of the UK's 471 Local Authorities offer recycling collection facilities for plastic bottles, ranging from one or two bring sites through to comprehensive kerbside systems. This allowed 182,000 tonnes of plastic bottles to be collected for recycling during 2007, equating to a recovery rate of 34.6% for that year¹¹.

There is evidence from this survey that mixed plastics streams are being collected from households as a part of wider dry recyclables collection. 108 Local Authorities (23%)¹¹ stated in the most recent survey that they were collecting plastics other than bottles within their recycling collections. These plastics included various combinations of carrier bags, packaging film, tubs and trays, plant pots, expanded polystyrene and other dense plastics.

Table 5 shows the breakdown of the different types of plastics which are being collected, the collection method and the number of Authorities who are collecting them.

Table 5 Number of Local Authorities collecting mixed plastics¹¹

	Carrier Bags	Packaging Films	Food tubs and trays	EPS	Other Dense Plastic	Plant Pots
Bring Schemes	32	14	23	0	11	11
Kerbside Schemes	30	10	32	1	3	13
Total	62	24	55	1	14	24
Increase on 2006	68%	41%	8%	same	75%	167%

In addition to the above data, it is expected that some plastics packaging is collected in other domestic recyclables collection systems albeit as contamination.

4.2 Mixed plastics within recyclables sorting systems

Mixed plastics are collected at the kerbside and they are generally collected together with paper, card, cans and plastic bottles as a partially or fully co-mingled collection which requires sorting at a Materials Recovery Facility (MRF). Therefore, these MRFs are observing an increase in the mixed plastics packaging entering their facilities.

To make a sorting facility efficient and cost effective, automated equipment is usually required to perform the majority of the segregation process within modern MRFs. However, as this equipment is relatively expensive it may not be available at all MRFs.

In a full co-mingled MRF, a primary separation machine is usually employed to separate fibre (paper and cardboard) from containers (plastic bottles and cans). There are a variety of sorting technologies currently available to complete this task including disc screens (i), trommels (ii) and ballistic separators (iii).

¹⁰ WRAP Local Authorities Plastics Collection Survey 2008 (based on 2007 data)

¹¹ Relating to 525,300 tonnes of bottles entering household waste stream

Figure 6 Paper and fibre separation technologies

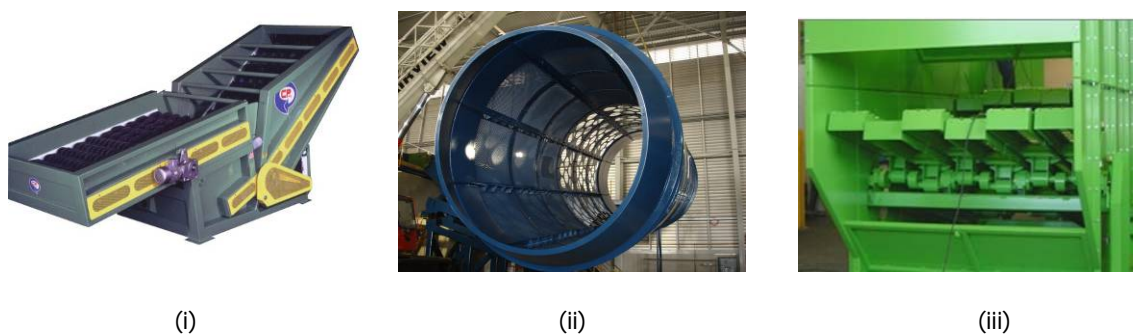

Once the main fibre separation has been completed a separate stream of container material is created. Standard equipment is used to remove the steel (overband magnets) and aluminium (eddy current separators) which leaves a final mix of plastics and residual material.

The last process in most MRFs is to sort the plastic bottles using manual labour or NIR sorting equipment. The bottles will be separated into a mixed bottle or polymer and/or colour sorted bottle fractions depending on site logistics and bottle market values.

Figure 7 Typical NIR plastic sorting unit



At present any non-bottle plastics flowing through the sorting system are likely to remain in the residual fraction at the end of the sorting process described above and be landfilled or sent for energy recovery. In a few circumstances other plastics may be removed either manually or by automated equipment such as NIR systems and this is expected to become more common in the new generation of MRFs.

4.3 Mixed plastic sorting in Germany

Other European countries have developed their recycling systems based on a packaging licence fee. There is more funding in these systems for recycling which has allowed significant further investment in packaging sorting infrastructure. An example of this approach is the German Green Dot system.

The packer fillers pay circa €1,300 per tonne of plastics packaging they put onto the market into the Green Dot system. This pays for the collection and waste management. In theory it also acts as an incentive to minimise the packaging going onto the market. Retailers and fillers can delegate their take-back and deposit obligations to service provider companies like Duales System Deutschland GmbH, similar to the UK system of delegating PRN obligation to a compliance scheme.

Germany has built an extensive indigenous sorting infrastructure which utilises known technologies including banks of NIR systems for several separations of a mixed plastics stream. This also leads to more developed

recycling markets for a wider range of separated and baled fractions such as PP plastic. This is interesting to the UK because it means that systems with demonstrated capabilities are available.

4.4 Mixed plastics resource flows

The three main waste management routes for domestic mixed plastics packaging in the UK are landfill, incineration and recycling.

4.4.1 Recycling

Information provided in sections 4.1 and 4.2 demonstrate that some mixed plastic packaging is collected in the UK for recycling, but this is not always separated from the residue at the sorting stage. This suggests that recycling of mixed plastics is lower than the amount collected for recycling.

Only 21 Authorities were able to provide data on the quantities of "other household plastics" collected for recycling with a total quantity of 10,857 tonnes reported. In addition, 74% of Local Authorities claiming to collect some non-bottle mixed plastics were unaware of the end market for the mixed plastic packaging fraction collected for recycling¹².

4.4.2 Incineration

DEFRA data confirms that 8% of UK municipal waste was incinerated in 2005/2006¹³. This is the equivalent of 2.8 million tonnes which is processed through the 15 existing incineration facilities. All municipal waste incinerators in the UK generate energy from waste (EfW) each treating between 80,000 - 600,000 te/year. Levels of incineration may rise in line with landfill reduction, although EfW incinerators may only be classed as "recovery" plants if EU led energy efficiency criteria is met¹⁴.

The primary financial driver for incinerators is the revenue derived from gate fees which relates to the throughput of a facility. Since plastic has a high calorific value, the feed rate into the incinerator is lower. It is unlikely to be financially viable for these facilities to receive a high tonnage of plastic rich streams on a regular basis as this would significantly affect the throughput potential. Although a higher gate fee could be applied to offset the reduced throughput, the limited existing UK incineration capacity means that throughput is the key factor. Where mixed plastic fractions are incinerated in the UK, it is combined with low grade paper at a ratio of no more than 20% plastics. Plastic only loads are not accepted¹⁵.

4.4.3 Landfill

The majority of UK domestic mixed plastics packaging is collected in residual waste and landfilled at a cost of around £56 per tonne which includes £32 landfill tax¹⁶. Mixed plastics collected through residues from sorting facilities are typically also landfilled.

The UK is currently landfilling 64% of municipal waste, or approximately 22 million tonnes¹⁷, and the landfill tax is seen as an increasingly important tool for diverting waste towards recycling and re-use. There are indications that implementation of Mechanical Biological Treatment (MBT) systems to pre-treat domestic residual waste could allow mixed plastics packaging to be recovered, but the level of opportunity is currently unknown.

¹² WRAP Local Authorities Plastics Collection Survey 2008 (based on 2007 data).

¹³ www.defra.gov.uk/environment/statistics/waste/kf/wrkf20.htm

¹⁴ Most existing incineration plants do not generate heat for use in the community, only electricity, since the unpopularity of incinerators means they are rarely built close enough to locations that could use the heat.

¹⁵ Confirmed by Grundens for supply of material to Slough incinerator.

¹⁶ The actual landfill cost will vary and £56/tonne is an indicative figure only.

¹⁷ www.defra.gov.uk/environment/statistics/waste/kf/wrkf20.htm

Figure 8 Domestic mixed plastics through the waste and recycling systems

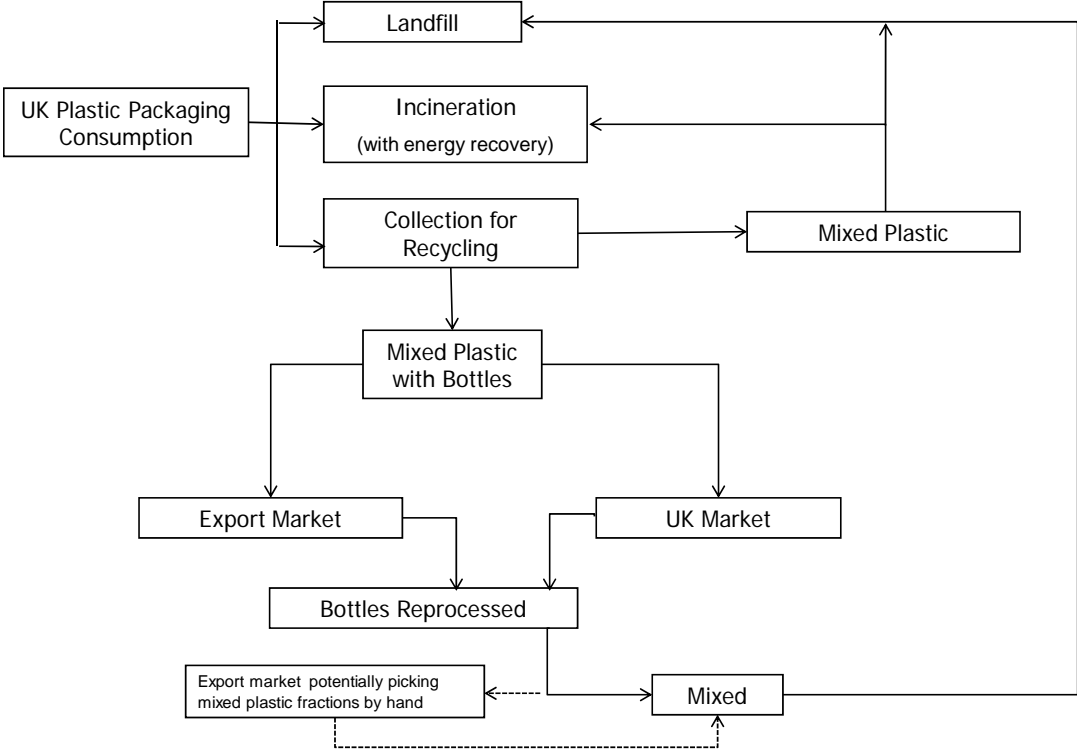

The conclusion must be that in the absence of developed collection and sorting systems or developed end markets, the majority of UK mixed plastic currently finds its way to landfill or energy recovery with only a fraction going to low grade recycling either in the UK or in export markets.

5.0 What is Domestic Mixed Plastics Packaging

5.1 Project definition of mixed plastics

This project is focussed on all non-bottle mixed plastic packaging sourced from the domestic waste stream. This includes rigid and flexible plastic items of the various polymer types and colours that are typically found in the household waste bin, but excludes plastic bottles and non-packaging items¹⁸.

When researching existing mixed plastic collection and sorting activities, it became clear that the definition above could not be practically applied to mixed plastics packaging collected for recycling from UK sources. In practice this stream did include plastic bottles, non-packaging plastics, other recyclables, and residual waste in varying amounts.

5.2 Plastic waste stream characterisation

There are many domestic waste assessments available from a number of sources including Local Authorities, waste management companies, consultancies and governmental bodies. These assessments reference a range of figures for each fraction of the waste stream with the reported proportions of plastic ranging from 8% to 12%.

Figure 9 Domestic waste composition by % weight with breakdown by plastic application¹⁹

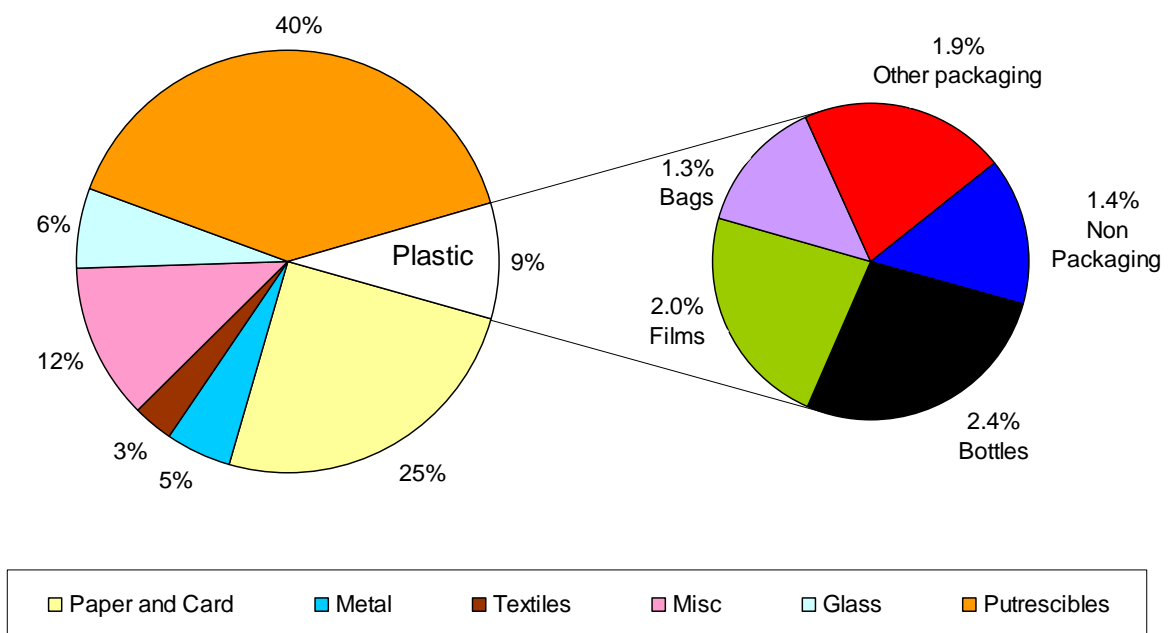

From the indicated 9% of plastics in the household bin, the total non-bottle plastics including films, bags, and other packaging comprise 5.2%. The specific non-packaging fraction is estimated at 1.4% of the bin by weight. While weight is the measurement used in most studies, volume is also an important consideration. The high-volume low-weight characteristic makes plastics a very visual element of the domestic waste stream.

Streams of mixed plastics varied greatly between collection systems and even material observed at the same sorting facility on different days showed some variation. These variations are based on a number of different approaches to the collection of domestic recyclables and also the approach to sorting those materials. However, many sorting facilities will be accepting input material from a range of Local Authorities and collection areas.

¹⁸ Non-packaging plastics typically include children's toys, cooking utensils, piping and cabling, household fixtures and fittings, electronic equipment, furniture.

¹⁹ An average dataset compiled by Recoup based on information from a number of sources including: Recoup, DEFRA, WRAP, and individual Local Authorities.

A typical composition of collected co-mingled household recyclables is provided below where mixed plastics are also actively collected. Glass is excluded as it was not observed in the facilities visited as part of this study. However, there are a limited number of co-mingled collections and sorting facilities that do include glass.

- News, magazines and mixed paper = 70%.
- Card = 10%.
- Plastic Bottles = 4%.
- Other mixed plastic packaging (where actively collected) = 10% (of which 7% is rigid).
- Steel and Aluminium = 3%.
- Carton board = 1%.
- Waste = 2%.

Waste is defined as the unrecyclable content in the collected recyclable stream which is typically removed by the sorting facility. A proportion of up to 10% is commonly used as a waste figure for a MRF, but the majority is clean, potentially, recyclable material that has been missed or classed as 'fines' and, therefore, unrecoverable through the separation processes.

Communications activities related to recyclables collection schemes including mixed plastics will also influence what the householder perceives as mixed plastic, and therefore what is put in the recycling stream.

5.3 UK domestic packaging arisings

Official government data for 2006 indicates that there was 2,079,865 tonnes of plastic packaging waste (including plastic bottles) of which two thirds, or 1.4 million tonnes can be attributed to the domestic waste stream²⁰. There is a general acceptance that packaging waste arisings are growing at between 2% and 5% each year.²¹ This suggests that domestic plastic packaging arisings (including bottles) will be 1.44mt to 1.52mt in 2008, increasing to a maximum of 1.65mt to 2.14mt by 2015. Some retailers have reported even higher growth rates²².

Figure 10 Domestic packaging arisings 2006 – 2015 based on 2% - 5% growth rates.

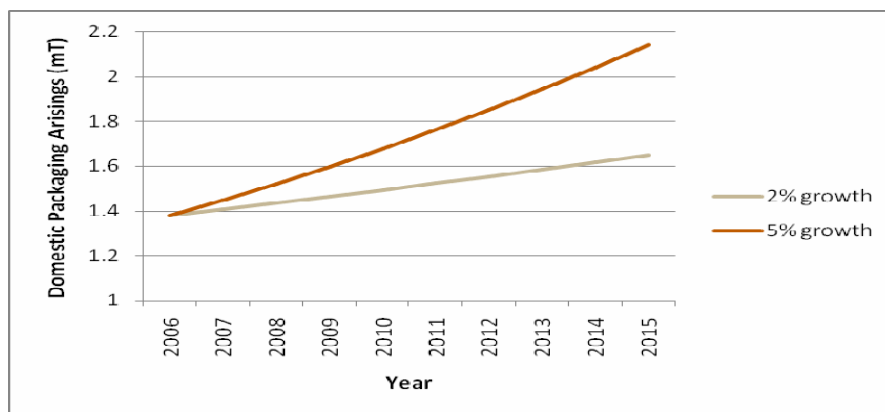

The data provided above only relates to consumption and does not necessarily reflect the composition of mixed plastics arisings from collection streams of recyclable materials. Evidence from plastic bottles collections suggests that certain pack types will be more popular for recycling and, therefore, be disproportionately represented within active mixed plastics collections for recycling.

5.4 Plastic types and estimated composition of domestic mixed plastic packaging







There are six main polymer types in the domestic waste stream including:

²⁰ Waste Strategy For England 2007 Annex D6 paragraph 121 identifies 'within plastic packaging waste, about two-thirds of this is estimated to arise in the household waste stream and one-third in the C&I waste streams'.

²¹ UK Plastics Waste – A review of supplies for recycling, global market demand, future trends and associated risks (WRAP).

²² ASDA confirmed a 6% yearly growth in plastic packaging at the WRAP mixed plastic conference, October 2007.

Figure 11 Polymer types

	PET	Polyethylene Terephthalate
	HDPE	High Density Polyethylene
	PVC	Polyvinylchloride
	LDPE	Low Density Polyethylene
	PP	Polypropylene
	PS	Polystyrene

There is some limited data on the composition of post-consumer plastics collected. Figure 12 presents the sample composition of a domestic kerbside collection of all mixed plastic packaging material in Stockport. A sample of 1,700 households were asked to place 'all types' of waste plastic into a clear bag that was collected at the same time as the normal weekly rubbish. This included bottles, a wide selection of films and the non-bottle rigid containers (tubs, pots and food trays) but did not include any residual waste.

Figure 12 Kerbside plastic sample composition from Stockport trial²³

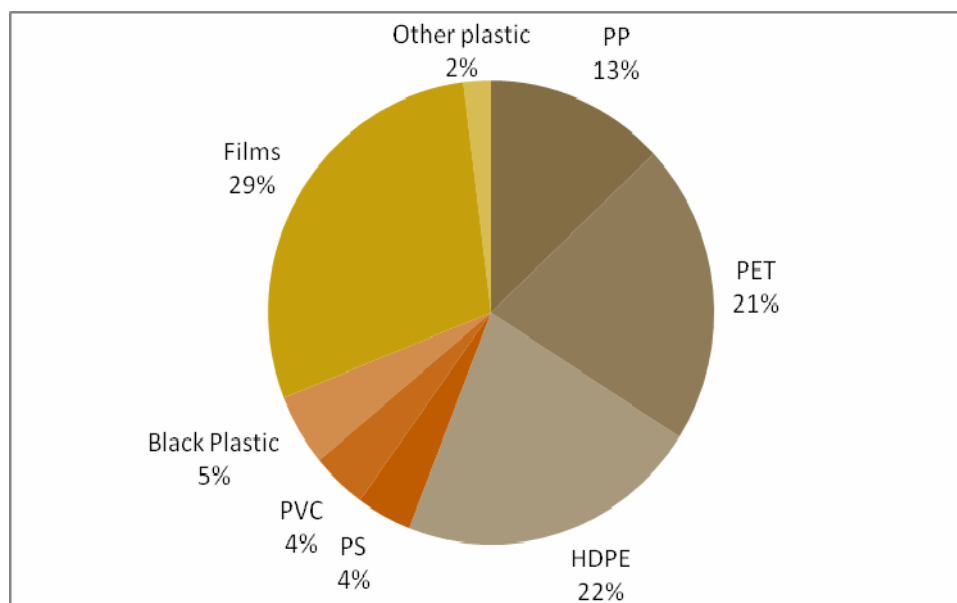

After the plastic bottles were removed from the collected Stockport material, it was concluded that:

- Residual rigid containers will make up a significant mass of the material.
- Rigid containers will primarily be made up of PET, PS, PP and PE polymer types.
- PVC will exist at a low level in both the containers and films fraction.
- Carton board type drinks cartons are likely to be a regular contaminant of the plastics stream.
- Domestic films are predominantly PE or PP based polymers, but are often multilayer materials (e.g. metallised, printed, heat-sealable plastic).

NIR sorting equipment has provided additional information on the composition of trial samples. While this may not be representative of all mixed plastics packaging arisings, it does provide a good insight into approximate compositions by area.

To highlight the natural variability within collected mixed plastics, the illustrative graph below (figure 13) demonstrates the trends and variations of the sample material. It must be noted that the NIR systems measure the sample by area rather than weight, and cannot identify black plastic which accounted for approximately 8% of the input mixed plastics samples or 35–50% on average of the trial residual fraction once all other polymers had been removed.

²³ Stockport household plastics collection and sorting trial – WRAP, June 2005.

Figure 13 Trial sample composition assessments by area

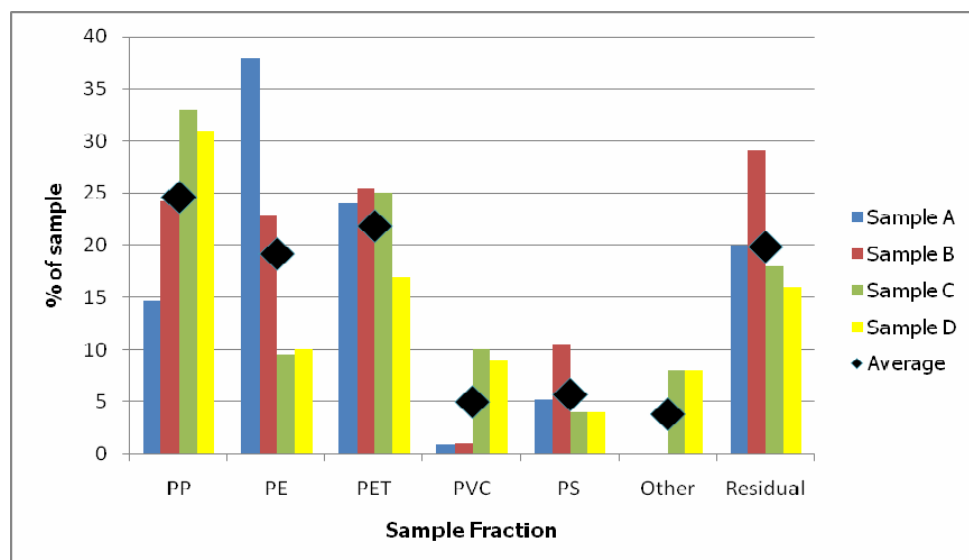

PP, PET and PE were the most common polymer types found. Residual out-throw was the fourth major fraction within the samples which included non-packaging plastics. Combined PVC, PS and the fractions added by Recoup such as PLA accounted for no more than 15%. There were differences between the samples due to the natural variation in the material mix. Sample A is indicative of a high bottle content sample reflected in the higher PET and PE fractions while sample B demonstrates a higher than average residual content sample.

This area-based assessment provides similar results to other weight-based assessments such as the Stockport trial data. For example the average content of PP in the trial samples was 25%, with individual tests ranging from 15% to 33%. The Stockport collection trial supports this indicating that 25-30% of a collected domestic mixed plastics stream is composed of PP once the PET, HDPE and film fractions are removed.

Since the area-based composition assessments support previous weight-based composition data, the proposed mixed plastic process designs in this study can be based on sorting the following inferred material mix by weight.

Table 6 Assumed composition per tonne of material input

Flexible		Rigids					Residual	Total
PE	PP	PP	PE	PET	PVC	PS		
25%	5%	17.22%	13.44%	15.33%	3.5%	3.99%	16.52%	100%

6.0 Legislation and Drivers

There are a number of policy, financial and technological drivers that influence UK plastics recycling. The current Thematic Strategies on 'recycling and prevention of waste'²⁴ are the main drivers, providing a focus on packaging and packaging-waste minimisation, and increased recycling and recovery through improved waste management techniques.

The DEFRA website confirms that 'this provides the overarching legislative framework for the collection, transport, recovery and disposal of waste, and includes a common definition of waste. The Waste Framework Directive requires all Member States to take the necessary measures to ensure that waste is recovered or disposed of without endangering human health or causing harm to the environment and includes permitting, registration and inspection requirements. The Directive also requires Member States to take appropriate measures to encourage firstly, the prevention or reduction of waste production and its harmfulness and secondly the recovery of waste by means of recycling, re-use or reclamation or any other process with a view to extracting secondary raw materials, or the use of waste as a source of energy. The Directive's overarching requirements are supplemented by other Directives for specific waste streams'.²⁵

The planning requirements of the Waste Framework and other directives have been transposed into national waste strategies. These are more general requirements to reduce waste disposal to landfill and increase composting, material recovery and recycling at a domestic level, targeting domestic waste through the preparation of Local Authority waste management plans.

Waste disposal costs are increasing each year with the most recent rises outlined in the Waste Strategy Document May 2007. This states that landfill costs will rise by £8 per year from 2008 for the next three years to a level of £48/tonne²⁶. Current average disposal costs are £56/tonne, including £32 landfill tax²⁷ and £24 gate fee. On this basis landfill disposal of domestic mixed plastics waste will cost £72/tonne by April 2010 assuming no further landfill tax increases are announced.

The Landfill Directive (99/31/EC) sets targets for the diversion of biodegradable municipal waste from landfill. The development of the Thematic Strategy has sought a ban on land filling of all residual waste by 2025, with more notable bans on all recyclables by 2015, untreated biodegradable waste by 2010, and recoverable waste by 2020.

6.1 Packaging waste regulations

The EC Directive on Packaging and Packaging Waste 94/62/EC (2004/12/EC amended) – the 'Packaging Directive' is implemented in the UK by the Producer Responsibility Obligations (Packaging Waste) Regulations 2005 by assigning a target to businesses that are set to meet national targets. The amount of packaging businesses are required to recycle is based on the role of the business in the supply chain, and the quantities of packaging they handle. Only businesses with a turnover of more than £2 million which handle over 50 tonnes of packaging are required or 'obligated' to contribute to Directive targets which are detailed in table 7.

In order to demonstrate compliance the obligated business (or a compliance scheme on their behalf) must purchase evidence of compliance from an accredited reprocessor or exporter in the form of Packaging (Waste) Recovery Notes (PRNs) and Packaging Waste Export Recovery Notes (PERNs).

²⁴ <http://ec.europa.eu/environment/waste/strategy.htm>

²⁵ http://www.defra.gov.uk/environment/waste/strategy/leg_dir.htm

²⁶ http://www.hm-treasury.gov.uk/budget/budget_07/bud_bud07_speech.cfm

²⁷ For the year starting 1st April 2008.

Table 7 UK plastics packaging recycling targets²⁸

Year	Plastic Recycling Target	Overall Recycling Target
2008	26%	72%
2009	27%	73%
2010	29%	74%

These targets will help ensure that the UK meets the 2008 EU Directive target of recycling at least 60% of packaging waste. Plastic recycling targets are achieved mainly through commercial and industrial rather than domestic plastic waste recycling.

6.2 Transfrontier shipment of waste regulations (1994)

This legislation applies to shipments of waste, within, into or out of the European Community, member states and other countries i.e. trans-boundary. Waste is classified into green list, amber list or red list according to its type. It is controlled appropriately to help protect the environment and human health. They also aim to prevent unauthorised disposal of international waste shipments, and the unregulated recovery of hazardous waste, but not hinder the legitimate trade in waste.

Separated domestic waste plastic is classified as “green list” non-hazardous waste, which means that no notification is needed for the trans-boundary movement of the material destined for recycling within the EU, or other non-EU OECD countries. This separation must ensure the plastic is not mixed with other wastes or recyclable materials and is prepared according to shipment waste regulations.

More stringent trans-frontier shipment rules in terms of acceptable contamination levels may limit export material streams. Restrictions in China may also inhibit export potential for mixed plastics. The most recent example of this is the banning of film from domestic sources into China from 1st March 2008.

6.3 Reach regulations (67/548/EEC)

The UK has the potential to incorporate and increase the use of recycled plastics in products. The implementation of the Registration, Evaluation, Authorisation and restriction of Chemicals (REACH) regulation is intended to create a single system for identification of all chemical properties of substances produced or imported in volumes over 1 te/year, through submission of safety data sheets by manufacturers and importers.

Waste is outside the REACH regulations. Polymers are exempt from REACH but their monomers and additives must be registered. The recovery of plastics from the waste stream will bring the recycled plastics within the scope of REACH as they will no longer be waste. The full implications of this are not yet clear.

A working group task force has been set up to submit generic safety technical data sheets for each polymer with a recycled content following the necessary chemical safety assessment, to alleviate pressure on plastics recyclers.

6.4 PAS 103 plastic specifications

Publicly Available Specification (PAS) 103 was created to improve the operation of the PRN/PERN system, by providing guidance for the accurate identification and quantification of plastics packaging waste destined for recycling and the creation of documented audit trails. Available from WRAP, it classifies plastic waste according to its polymer type and original use, and identifies any contaminants. This is useful for recycling companies in setting purchasing specifications. Collectors, sorters and traders of plastics waste will be able to maximise the value of their material by understanding the precise needs of the recycling industry.

6.5 Product design

As part of the Packaging Directive, packaging is required to comply with ‘essential requirements’. The Packaging (Essential Requirements) Regulations 2003 (as amended) specify requirements for all packaging placed on the

²⁸ <http://www.defra.gov.uk/news/2008/080211a.htm>

market, including a requirement that packaging should be manufactured to limit packaging volume and weight to the minimum amount necessary to maintain the required levels of safety, hygiene and acceptance for the packed product and for the consumer. In addition to the design and use of packaging that is required to permit maximum reuse and recovery options within existing recycling streams.

Product manufacturers and companies face increasing pressure to reduce the environmental impact of their products throughout their life cycle, while maintaining a requirement to satisfy technical customer and consumer needs. Packaging is a primary application for plastics and is becoming a major consumer focus, with increased demand for recyclable packaging and provision of adequate plastics recycling facilities.

6.6 Non legislative drivers

There are also a number of other drivers for plastics recycling. Growing environmental concerns and householder awareness has increased demand for convenient recycling facilities that include the widest range of plastics possible.

The opportunity through increasing bottle collection and sorting infrastructure allows good practice to be circulated. Government funding has also allowed collection systems to be subsidised in some areas. The growth of sustainable choice of end markets provides confidence in the recycling system and creates competitive prices for material. This still needs to be developed for mixed plastics.

Recycling has become mainstream as part of the wider interest in environmental issues which now uses 'carbon' as a primary indicator of performance. Recent research from WRAP which reviews LCAs indicates that plastics recycling is a better environmental option than incineration or landfill. But it is also suggested that for every 1 tonne of plastic recycled, at least 1.5 tonnes of carbon is saved²⁹.

²⁹ *Environmental Benefits of Recycling: An international review of life cycle comparisons for key materials in the UK recycling sector, WRAP 2006 section 3.4.1 : Plastic Main Findings.*

7.0 Project Approach and Method

The project evaluates the technical, environmental and economic viability of mechanical recycling benchmarked against alternative waste management options. Practical trials were completed to assess the performance of mechanical recycling technologies. Environmental and economic assessments were also completed.

The five key areas of the project were:

- Trial technology selection.
- Supply of material.
- Operational trials.
- Technology benchmarking.
- Process development.

7.1 Trial technology selection

An open invitation was issued for recycling technology providers to participate in the project. This was advertised in Material Recycling Week (MRW) and Lets Recycle, and also actively promoted amongst steering group contacts and at the 2007 Recycling and Waste Management Exhibition.

From the thirteen proposals received, six were selected for operational trials, comprising of 14 technologies.. They were based on a variety of approaches to sorting mixed plastics, with four independent technology providers and two independent management companies providing combined technology process solutions including

- Axion Recycling Ltd.
- Nextek Ltd.
- Pellenc Selective Technologies.
- QinetiQ group PLC.
- Sims Recycling Solutions BV (SRS).
- Turbo Laminare Trenntechnik Kunststoff-Recycling Anlagenbau GmbH (TLT).

7.2 Supply of trial material

The input material for the trials was sourced from Valpak Recycling in Preston³⁰. This facility accepts plastics and cans from a range of domestic recyclables collection systems in the UK. Plastic film was removed by two operatives, the cans sorted using an overband magnet and eddy current separator, and the bottles separated using automatic NIR units. The majority of the remaining residual fraction was mixed plastic packaging. The film was then remixed with this fraction to produce the base input material for the trials.

³⁰One trial was supplied with material from another facility due to logistic issues. This was a lower grade material which was further processed to remove contaminants and achieve input material comparable with the other trials.

Figure 14 Example of loose mixed plastic packaging supplied to trials



Figure 15 Example of baled mixed plastic packaging supplied to trials

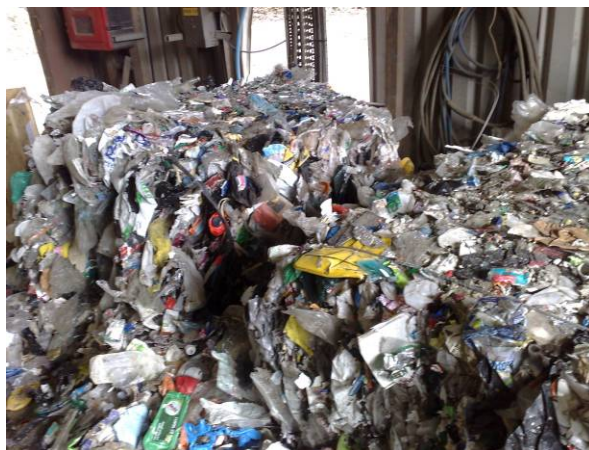

Technology providers then identified any specific fractions that were incompatible with the sorting system and this was manually removed along with any obvious non-plastic packaging contamination. The trial material input was composed of pots, trays, tubs and films, plus some paper, cans and plastic bottles. Additional components such as PLA trays and carton board were added if the technology claimed to sort these fractions.

7.3 Operational trials

7.3.1 General approach

The operational trials were completed between November 2007 and March 2008. Fifteen of the nineteen trials were based in mainland Europe, and a further four in the UK. Subject to technology provider agreement a member of staff from Recoup and PPS was present at each trial. A Scott Wilson representative also attended selected trials.

Priority was given to sorting those polymers, or combinations of polymers, that were more abundant, more easily extracted, and more likely to have an end market value. The input and output fractions were weighed where possible, with accompanying photographs of the various output streams. The outputs were also taken for offsite testing to confirm the separation levels achieved.

The level of segregation was linked to two parameters: purity (of the ejected stream) and efficiency (based on losses of specified ejection material in the residual output).

Further data for each trial was obtained such as capital costs, manning, and consumables required to segregate the trial materials. This provided data on cost effectiveness and fed into a financial review for assessing the development of full scale recovery options or running larger trials. Photographs, videos and schematic drawings that are necessary for the operation of the equipment have been supplied, subject to technology provider agreement.

7.3.2 Whole item separation trials

The following approach was adopted for technologies that separate whole items of mixed plastic waste. The trial material was loaded onto a metering conveyor where available, or directly onto an infeed belt. This fed material into the sorting unit with the output bins or belts configured to allow removal of the ejected fraction. The film separation trials were relatively straightforward with a single pass of material producing rigid and film (or 2D and 3D) output fractions.

All rigid item separation trials on whole plastics packaging items were completed using a similar approach. Each was based on closed-loop systems so the sample material could be circulated several times. This allowed each ejection stream to be selected for removal and analysed as required without compromising the rest of the sample. The circulation time was also known and measured during the trials to ensure separation performance was based on a single pass of material through the unit.

In each case the first trial was to sort each of the main type of polymers one after another (PP, PE, PET, PVC, PS) to assess the maximum purity achieved by the technology. Other items such as PLA, carton board and cans were then ejected where the technology permitted.

After each separation, the ejected fraction was then sorted by hand to determine the purity levels, and identify contamination and reasons for the contamination where appropriate (e.g. polymer combinations in a single item). Purity of each ejected fraction was measured in weight and in %. Where possible this set of tests was repeated on a second sample for comparative purposes.

Figure 16 Hand sorting of separated plastic fractions



Titech Trial



Pellenc Trial

A further test then adopted a commercial approach to sorting the input material using higher throughput rates with the same purity and efficiency parameters being applied.

7.3.3 Flake separation trials

Flake separation technologies can be used as a primary sort or as a 'polishing' process after whole item separation. The following approach was adopted for technologies that sorted or polished or flaked plastic material.

Firstly, the input material was reduced to a mixed flake to the specification required by the technology using a suitable granulator. The flake size varied from <10mm to 25mm depending on the technology and whether the trial was conducted in a commercial or test facility³¹.

The trial material was passed through some or all of these technologies in sequence to produce the final output fractions. Where there were a number of proposed output streams (PP, PE, PET, PVC, PS), the trial was run a number of times using the same test unit.

The approach to each trial was to feed-in a measured mass of each sample of plastic material over a timed period. The flake sorting processes were fully automated once the material feed rate had been set. Output flakes and other fractions such as waste were collected in bags. After completion of each test the collected outputs were weighed to check the mass balance and assess the level of material losses³².

The flake trials provided a more diverse set of technologies with a number of alternative approaches to achieving marketable output fractions. This included dry cleaning, hot wash, sink float, optical sorting, laser based separation and electrostatic separation. Each separate trial produced output fractions that were independently assessed for purity and efficiency.

³¹ Some facilities used smaller test equipment and infeed /outfeed pipes for the trials. Therefore, these trials required a smaller flake size than normally required at a commercial facility.

³² Some material may remain inside the equipment after the trial is completed and therefore counted as a loss. As more material is processed, this remaining element would be pushed out.

7.4 Technology benchmarking

The benchmarking work compared each technology trialled based on standard financial and environmental datasets as detailed below. Data from alternative recovery and disposal options were also reviewed for comparative purposes.

The approach has allowed overview comparisons to be made between trial processes, and against alternative waste management options to highlight any financial and environmental justifications for developing mixed plastics recycling activity in the UK.

7.4.1 Financial benchmarking

A data sheet was set up to capture the relevant financial information from each technology and also for alternative technologies. Process finances were reviewed and modelled on the basis of information provided by the manufacturer or agent and additional information collected during the trials as corroborated by Scott Wilson and PPS. This was complimented by generic data such as labour, land, power and water costs.

Financial performance considered issues such as direct and indirect facility cost, gate fees and output values. This was based on ten indicators obtained from technology site project partners:

- 1 Process Input: UK sourced, mixed-non-bottle fraction plastics, including film, or container fraction derived from this, or pre-separated film or rigid (container) fractions derived from mixed domestic plastics.
- 2 Process input (tonnes/hour).
- 3 Output streams produced.
- 4 Equipment capital cost (including installation and requisite ancillary equipment, where possible).
- 5 Equipment power rating (maximum - kW and loading during operation %).
- 6 Water consumption (m³/hour).
- 7 Other consumable costs (£/tonne input).
- 8 Labour requirements.
- 9 Spares and maintenance costs (% of capital cost/year).
- 10 Operational floor area requirement.

To provide clarity and comparability across the datasets collected, some of the items were standardised. For example, the amortisation period was assumed as 10 years linear across all technologies, and other datasets such as spares and maintenance always expressed as a percentage of the capital cost.

7.4.2 Environmental benchmarking

The environmental benchmarking activity was a LCA led approach to the comparison of environmental performance of the mixed plastic sorting technologies. The scope of the LCA was from 'MRF gate to reusable/saleable output material or recycled product' and was carried out using LCA software. The study was based on data collected from the trials supplemented where necessary with generic data obtained from Life Cycle Inventory (LCI) databases and other literature sources. It reviewed both the impacts from the recycling process (or alternative disposal route) and the benefits from producing the recycled materials and other recovered products.

Resource and energy usage data was collected from the technology providers either during or after the material sorting trials to provide baseline datasets. The CML 2 Baseline Method characterisation factors³³ were applied in this study with the following impact categories assessed:

- Global Warming Potential (GWP).
- Photochemical Ozone Creation Potential (POCP).
- Eutrophication Potential (EP).
- Acidification Potential (AP).
- Human Toxicity Potentials (HTP).
- Ozone Layer Depletion Potential (OLDP).

³³ LCA - An operational guide to the ISO-standards, Guinée et al, Final report, May 2001 - <http://www.leidenuniv.nl/cml/ssp/projects/lca2/lca2.html...> also add ref to characterisation factors).

■ Abiotic Depletion Potential (ADP).

The CML 2 Baseline methods are based on the best available models drawn up by the SETAC-Europe Working Group on Impact Assessment. The CML impact indicators focus on the midpoints of the cause-effect chain. This means that they aggregate data on emissions (the starting points in the cause-effect chain) to potential impacts in various categories (e.g. global warming, acidification), but do not go as far as to assess the endpoints (such as loss of biodiversity, damage to human health, etc caused by these impacts). The method is referred to as a problem-oriented approach.

Primary energy consumption and solid waste arisings were added to the list of impact categories. The priority impact categories for WRAP were confirmed as GWP and solid waste.

A series of alternative options were also included in the environmental benchmarking, as a desk based study, to provide comparison with the recycling technologies. The options considered included;

- landfill;
- incineration with energy recovery (EfW);
- pyrolysis technologies (feedstock recycling; conversion to diesel);
- redox agent for blast furnace injection (coke substitute); and
- SRF to cement kilns.

Environmental modelling was then completed to demonstrate environmental performance of the sorting technologies against alternative waste management options.

7.5 Process designs

Once the separation trials and benchmarking activities were completed, the three processes that were most likely to provide the best financial case and highest landfill diversion were modelled. This combines the most appropriate technologies identified to provide full practical process designs for the sorting of domestic mixed plastic packaging.

There are justifiable assumptions and variables built into the process design development, including the output market values for various plastic fractions. A brief market assessment was completed³⁴ to provide value ranges which have been applied to the process designs.

The process designs were configured to provide robust systems that are compatible with current domestic mixed plastic packaging arisings, while optimising throughput efficiency and payback on capital investment.

The timeframe for the analysis extends beyond 10 years and it was assumed that investments are made in 2008 with commissioning at the beginning of 2009. An economic model was developed to test the viability of projects to suit the specific requirements of this project.

Key inputs consist of assumptions regarding:

- revenues;
- technical yield factors leading to variable operating costs;
- capital expenditure;
- working capital assumptions;
- inflation assumptions;
- funding structure; and
- tax liability.

³⁴ Market questionnaires compiled by Axion and Recoup to provide indicative values for sorted plastic packaging fractions.

Key model outputs can be summarised as:

- cash flow profile;
- net present values and internal rate of return; and
- sensitivity test / results.

8.0 Mixed Plastic Packaging Recycling Trial Results

This section provides an overview of the technology trials completed for the separation of domestic mixed plastics packaging.

There were six proposals selected for mixed plastic sorting trials. This included four applications directly from technology providers (Pellenc, QinetiQ, Sims and TLT), and a further two proposals from Axion and Nextek, each of which incorporated a range of separation technologies.

The trials can be categorised based on the type of separation;

- Film separation (sorting flexible plastics from whole rigid items).
- Whole item separation (sorting whole rigid items by polymer or colour).
- Flake separation (by polymer or colour) and washing.
- Cleaning or polishing of flakes.

8.1 Separating flexible plastics from whole rigid items

Two technologies were specifically tested for the removal of plastic films and other flat items from a rigid mixed plastics fraction. These were the KME Air Drum Separator and the Stadler Ballistic Separator STT2000 as shown in figure 17.

Figure 17 Stadler STT2000 and KME Air Drum Separator



The Stadler process sorts flat flexible items from rolling rigid containers. This equipment is used widely in commercial facilities to sort a paper fraction from a mixed container stream. The system uses paddles arranged in a 'deck' to produce a vigorous shuffling motion. The force of the rotation throws flat material upwards and forwards, and the rigid items then roll down and back. The model trialled used two decks arranged vertically within a single unit to achieve a total of four output fractions: rigid items, fines, film 1 and film 2.

Figure 18 Material flow through a Stadler unit

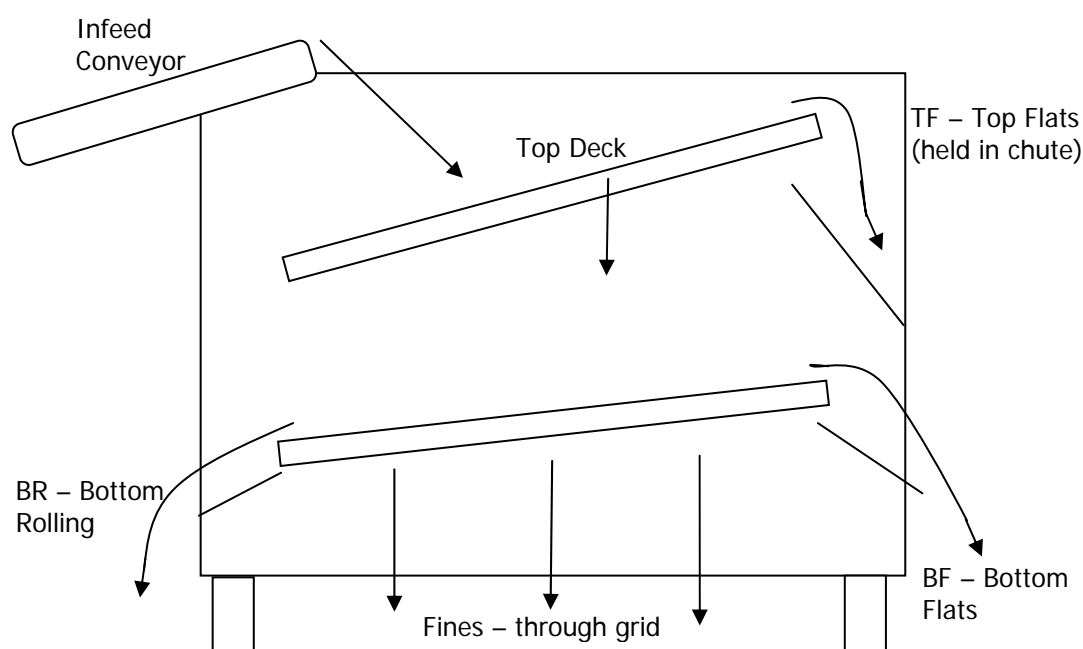

The KME Air Drum Separator system separates 2D and 3D items. Again in commercial use a paper removal system, the machine consists of an Air Drum Separator and a rotating perforated drum with internal suction over a section of the drum. This suction attracts the 2D/flexible material to the drum, leaving the 3D material free to continue. A splitter device then separates the two streams for further processing.

Table 8 Film separation trial results

	Stadler	KME
Rigids purity	99.5%	97%
Film purity	86.4%	78.5%
Throughput tph	6	2.5 - 3

The results of the trials demonstrated that both technologies were capable of achieving a high level of separation. The Stadler unit removed 99.5% and KME 97% of the film content from a mixed plastics fraction. However, the film fraction in both cases was more contaminated (Stadler 86.4% and KME 78.5%), particularly with flat rigid items and paper. This would require a manual QA step after the unit to clean up the film fraction before sale to market or further processing.

While the KME unit requires lower capital investment and maintenance, it also represents a lower throughput and the film purity is not acceptable. This is a function of the unit design which is intended for the separation of 2D and 3D items, whereas the Stadler unit separates rigid from flexible items.

A Titech unit was also tested to demonstrate NIR ability to clean a film fraction by ejecting rigid items. While this was relatively successful, this approach is not recommended as the significant presence of film in a NIR input stream can cover the rigid packaging which reduces the ability to accurately identify and eject individual packaging items.

Figure 19 Pictures of output from Stadler



Figure 20 Pictures of output from KME



Film separation is an essential step in the plastics sorting process that ideally needs to be applied before rigid separation occurs. The Stadler unit will be the selected technology for separation of film from rigid items in this study. The KME unit could then be used for a QA clean up function on the film fraction, but has not been tested within these trials.

8.2 Separating whole rigid items by polymer or colour

A number of technologies are already available for the polymer or colour separation of plastics. Those selected for trials in this study were Pellenc, QinetiQ, Sims and Titech.

Figure 21 NIR sorting equipment



Pellenc



QinetiQ



Titech

The technology for sorting whole rigid plastics is based on cameras operating in the NIR to or visible parts of the electromagnetic spectrum to achieve polymer or colour sorting. This type of unit is widely used in the UK for plastic bottle separation, and in Europe for sorting both bottles and other packaging plastics.

Material is spread out on a conveyor belt and fed underneath an identification sensor. This sensor uses an infrared beam to identify the plastic type by recognising a light intensity reading which is unique for each polymer. The unit then triggers air nozzles which separate the selected materials as programmed. The units are capable of sorting PP, PE, PET, PS and PVC, and can also be programmed to identify PLA, carton board and metals.

Figure 22 Examples of signature recognition from infrared units

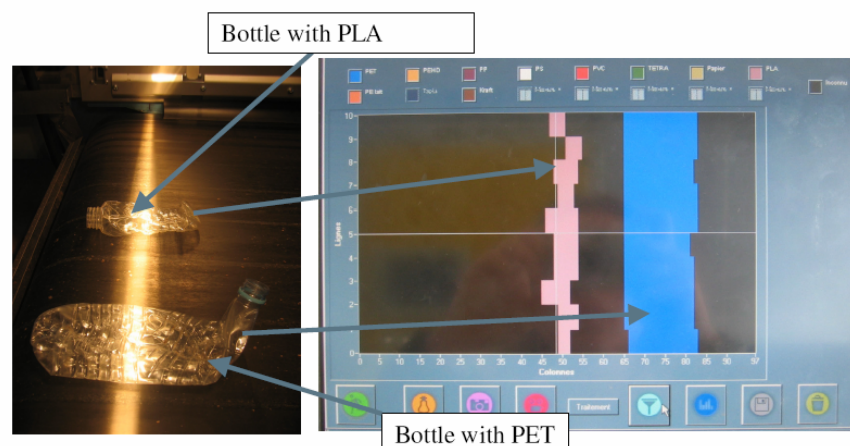

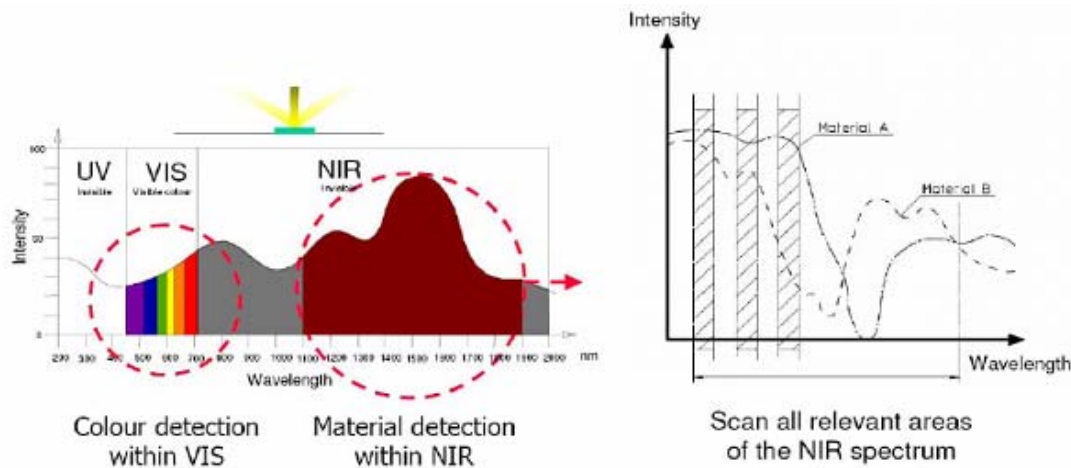

All units can be configured to remove a number of plastics in a single pass, or utilise a double split from a single pass of material. The QinetiQ hyperspectral fluorescence system design is slightly different in that it used a single identification unit to achieve up to four polymer separations in a single pass.

The material throughput rates for the trials varied depending on the equipment set up and infeed system. Pellenc, Sims and Titech were all able to operate at 3 tonnes per hour achieving the purities shown in table 9 for a single eject fraction. The QinetiQ system achieved 5 tonnes per hour with four eject fractions.

Table 9 Whole item separation trial results

	Pellenc	QinetiQ	Sims	Titech	Representative
Purity	98%	58%	93%	98%	96%
PP	92%	94%	94%	96%	94%
PE	95%	88%	98%	94%	94%
PET	88%	86%	93%	80%	87%
PS	99%	94%	93%	85%	93%
PVC	100%			95%	97%
PLA					
Throughput tph	3	5	2.8	2.8	3

All four systems demonstrated that individual polymers could be successfully identified and removed from a rigid mixed plastics stream. The purity of each stream was relatively consistent across the trials.

A key weakness of the NIR sorting technologies is when an item contains more than one material or plastic type eg label, the identification sensor may not recognise the item, or identify it based on identification of the minority material. Further mis identification can occur through householders placing one item inside another or two items being stuck together – usually through compaction or baling.

Certain results such as the QinitiQ separation of PP plastic and Titech separation of PS plastic were below expected results, but these systems have been proven to separate the relevant fractions to a similar level as the other NIR technologies. The trial throughput rates vary due to the design and configuration of each unit.

When operating within design capacity a small reduction of ejected purity can be expected as throughput increases. When the design capacity is exceeded the purity of the ejected fraction will rapidly decrease. The number of items missed by the unit will also increase. These factors are dependent on the composition of the input material.

The systems are capable of being trained to identify new polymers or variations of polymers. This function was utilised to identify PLA bioplastic within the streams and successfully eject them from the mixed plastics fraction. Carton board can also be removed in the same way.

NIR systems can be designed to sort colour but the equipment available at the trials were not configured for this task as polymer separation is the more popular application for this technology. This does potentially allow for a single NIR unit to separate a single-polymer single-colour fraction if required, operating at an indicative 90% purity level. However, this approach would require multiple units for each polymer, or for the material to be re-circulated with the unit removing a different colour for each circulation.

Infrared cannot identify black items and therefore the majority of black plastics remain in the residual output stream irrespective of the polymer type

Due to the similar performance of the whole rigid plastics packaging sorting technologies, it is reasonable to use a generic NIR dataset for each polymer separation required for this study (see representative column in table 9).

To achieve significant throughput a manual separation of mixed plastics should not be used. Each MRF operative can manually sort bottles at approximately 50kg per hour so 20 operatives are needed for a 1 tonne per hour material throughput. Mixed plastics are more difficult to identify and handle so it can be expected that sorting rate and efficiency would be significantly reduced.

Figure 23 Examples of sorted rigid plastics output fractions



PP output



PVC output



PET output



PLA output



PE output



Unsorted residue output



PS output



Hand sorted black plastic from residue output

8.3 Separating flaked items by polymer or colour

Polymer or colour sorting technologies are also available for flaked plastic packaging. There are also technologies that will potentially add value to plastic flake using cleaning or polishing techniques.

8.3.1 Flake sorting by polymer

There were five polymer flake sorting technologies trialled for this study. This included processing lines from B&B, Flottweg, Herbold, Swiss Polymera and TLT. The observed systems used a shredder, friction cleaning, air classifier and pre-cleaning equipment to remove excess contamination and dirt from the material before the separation stage. The flake sorting technologies were not designed to handle significant quantities so this pre-treatment is required particularly to remove paper and carton board.

Figure 24 Polymer flake sorting systems



B&B System



Flottweg Sorticanter



Herbold system



TLT system

While the exact configuration and approach of each process is different, the underlying principle is the same. The technologies use the different densities of plastic types to separate flaked plastic fractions in a liquid. The polyolefin plastics³⁵ have a density lower than water, and other plastics have a density greater than water. The majority of contamination would also sink and any items that float would not be present in high enough quantity to be of concern. Therefore a basic polyolefin separation is achieved when mixed flaked plastics are placed in water as shown in figure 25.

Figure 25 Example of flake sorting of PO by density and secondary polymer separation using a liquid with a density of 0.92g/cm³

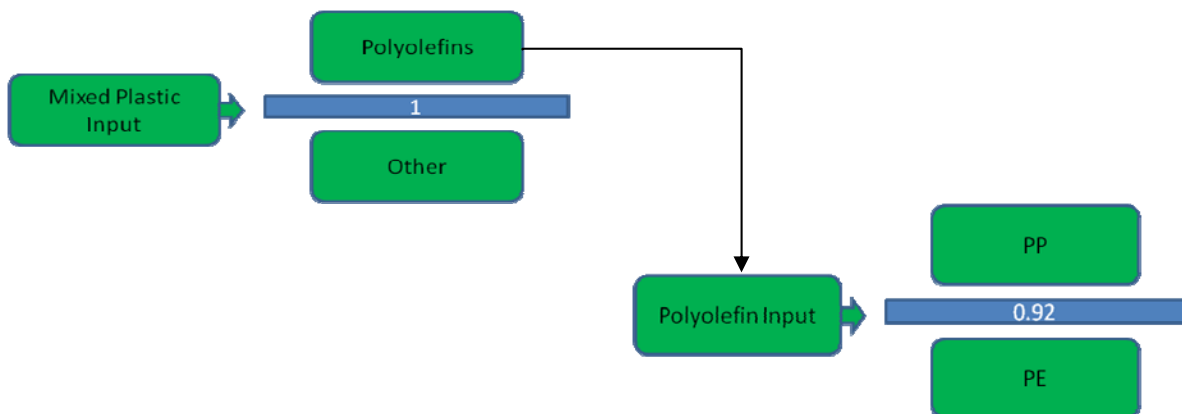

The systems trialled also used agitation of the liquid to encourage separation of the flake. The TLT and Flottweg systems were also tested using base liquids diluted to the correct density to achieve further fraction separation by specific polymer. Generic polymer densities are provided in figure 26 below. Once the output is dried and bagged, it can be sold as clean PO flake. These existing systems do not focus on the heavy fraction which is classed as residual waste.

³⁵ Polypropylene and Polyethylenes.

Figure 26 Indicative density ranges for common polymers³⁶

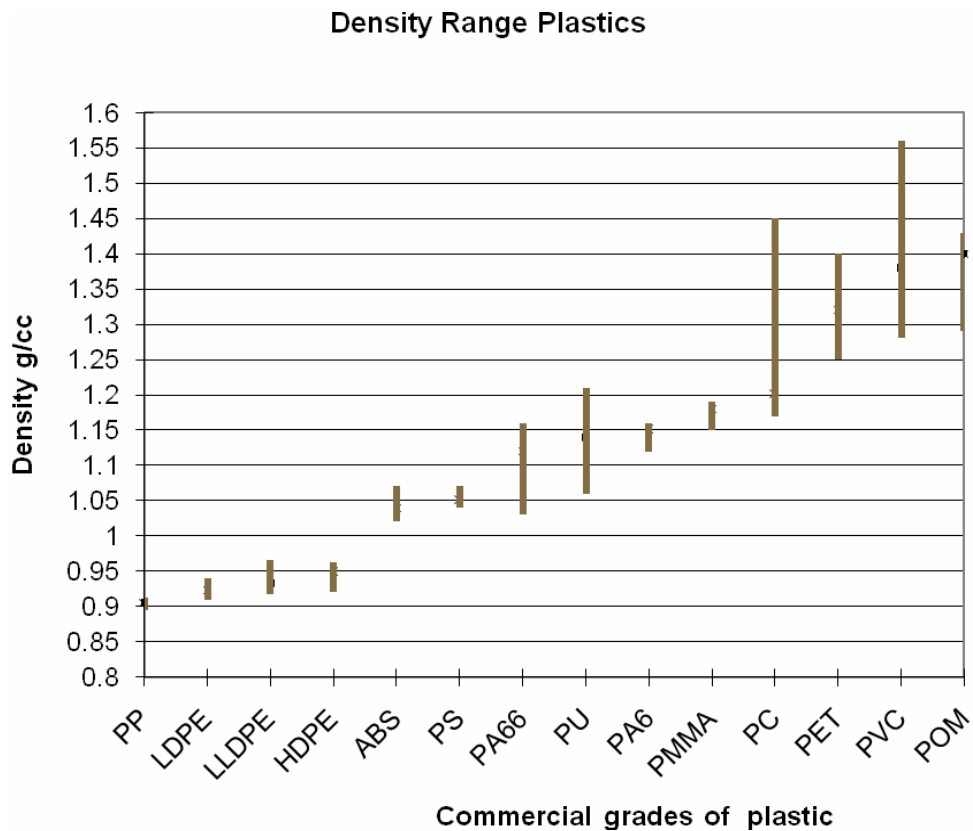

As an example, figure 27 below shows the material flow in a Flottweg Sorticanter. The moving parts consist of a conical cylindrical bowl and a tapered conical screw section both rotating on a common horizontal axis. The drive mechanism is designed so that the bowl and the screw section are rotated at different speeds, thus imparting a drive to the solids particles through the length of the separating chamber. This allows the tips of the scroll flights to effectively push the sinking particles of solids up the conical section to the right-hand side of the diagram. Solids lighter than the liquid phase float and are carried with the liquid flow to the other end of the centrifuge, where they enter the conical bowl to be skimmed away from the liquid surface and discharged from the unit.

Figure 27 Flottweg technology process diagram³⁷

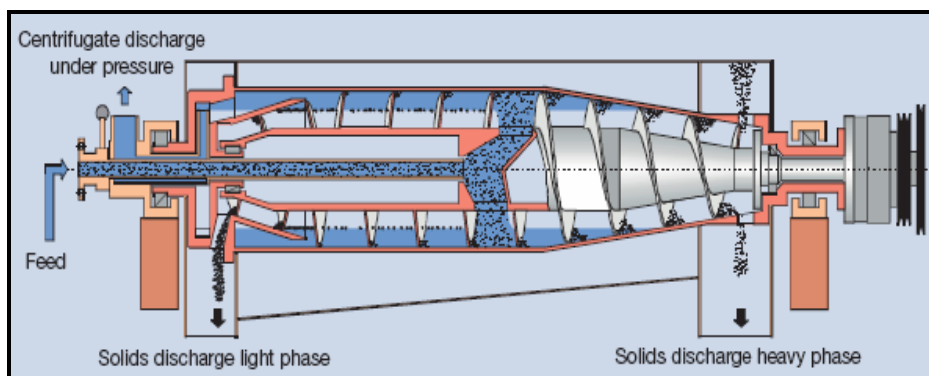

³⁶ Provided by Axion from data sourced at <http://www.matweb.com/search/SearchSubcat.asp>

³⁷ A moving diagram of the flottweg technology can be found at http://www.flottweg.com/sorticanter_en.html

Four of the trials were completed based on a separation of 10-15mm flaked mixed plastics packaging in a single unit. The Swiss Polymera system used a two-stage approach with an initial 40mm flake being fed into a water based float sink unit, and the float fraction re-shred to 12mm before a second water float sink to produce a high purity PO flake. The heavy fraction from both units was sent for residual waste management. This system also operated an extrusion line at the same site to produce a PO pellet from the flake output and densified film pellet.

The output float flakes from the processes were tested at independent facilities to assess the purity. This was achieved using a combination of infrared and float sink tests on 100 sample flakes under controlled laboratory conditions. The results of these tests are provided in figure 28.

Figure 28 Polyolefin flake separation trial results and photos

	B&B	Flottweg	Herbold	Swiss Polymera	TLT
Polyolefin purity	100%	99%	98%	100%	95%
Throughput tph	1	1.25	1.3	2	4



Cleaned polyolefin output from Herbold



Float fraction from the B&B process



TLT float fractions PP



Flottweg float fraction after independent flake testing

The separation of flake by specific polymer was not as successful with purities of 94% for PP, 90% for PE, 75% for PET, and 57% for PS being observed. Some plastics have similar densities and it was difficult to achieve a clean split during the trial. However, a combined PO output was produced which was comparable with the other PO float sink trials. It was found that the PLA bioplastic within the trial material had a similar density to PS, so affected the purity level of this output.

The technology provider noted that if a materials origin and composition can be confirmed prior to the test, and a preparatory test completed on the material, it is feasible that mixed plastics can be sorted not only by a polyolefin float fraction, but also by specific polymer types such as PP, PE, PS and PET to above 95% purity levels.

It can be concluded that the separation of polyolefin plastic flake using a density separation technology can be very efficient. Assessment of the output purity demonstrated that the systems tested were capable of achieving

at least 98% material purity. Some systems such as the Flottweg Sorticanter also delivered a good drying effect with the output plastics stream measured at around 10-15% moisture content³⁸. However, the capital cost of these systems is high in comparison to whole item sorting systems.

Sorting by specific polymer type is not viable, and polymers with similar densities are very difficult to separate accurately. Slight variation in liquid density will affect the separation, and may also cause flakes to be suspended in the liquid. If material enters the system which is not expected, it is not possible to detect or remove this plastic and it will cause contamination of a polymer with a similar density. If a number of units are used in sequence, a bad separation in one tank will also affect the quality of all the separations downstream.

The sink fraction in these trials was predominantly PET (including Crystallised PET (CPET)) at approximately 70% to 85% with polystyrene at 10% to 20%, and PVC at approximately 3% to 6%³⁹. The PLA bioplastic was also found within the sink fraction. While this was sent for residual waste management there could be an opportunity to separate the polymers before flaking, and then process through the density separation systems as a quality assurance stage rather than primary separation. Alternatively new technologies such as glycolysis could also offer a solution for the PET component of the sink fraction. Glycolysis uses heat and a chemical catalyst to depolymerise or break down PET flake. Eventually all the plastic particles are decomposed, producing ethylene glycol and terephthalic acid outputs.

Plastic films need to be processed separately through density separation systems, and the throughput rate will be reduced by at least 50% compared to rigid flake processing. This is because the film shred is lighter and reacts differently during the separation process. The Swiss Polymera system functioned in this way with the resulting sorted clean PO film flake agglomerated and extruded. The flake separation systems cannot accept high levels of contamination, with paper and carton board causing particular problems.

For the levels of dirt and contamination seen in these trials, it would be necessary to operate with a high bleed-off rate of the dirty wash-water from the recirculation loop as contamination and dirt in the water will change its density which needs to be controlled for effective separation. This would lead to a high cost of water treatment and effluent disposal costs, and additional downtime for maintenance. Dirtier material will also lead to higher maintenance costs.

Therefore the preferred approach would be to carry out some pre-treatment, e.g. a dry washer, to reduce overall contamination levels down to below 5% before feeding into the density separation unit. An alternative approach would be to encourage primary recyclables sorting facilities to produce a plastic output to a suitable specification. The presence of materials free from metal, paper and film would allow the processes to be operated more efficiently and eliminate expensive water treatment and disposal costs.

Within this system, there is no capability to sort the segregated polymer types into colours as different colours do not change the density of the polymer. Therefore an end market for the mixed colour polymer would have to be used or subsequent equipment would be required to colour segregate each polymer type.

The Hamos electrostatic separation technology was also tested to separate mixed polymer flake. This was tested for PVC removal from PET, and also PP from HDPE flake. The level of separation was not acceptable for either of the trials. This technology is primarily used as a clean-up function for removing PVC from PET flake, and the level of contamination within the trial material provided was deemed too high to be considered successful.

8.3.2 Flake sorting by colour

Three technologies were trialled for colour separation of flaked plastics. Sortex, SEA Srl and S+S use cameras⁴⁰ to identify and sort different coloured flakes at varying wavelengths. The light intensity is reflected off the product and measured allowing flakes to be identified.

The appearance of an unrequired colour initialises an ejector that uses a short blast of compressed air to blow the item out of the product stream. These systems operate at high throughputs⁴¹ so require fast, precise ejectors

³⁸ when there was little paper present in the mixture.

³⁹ According to Nextek trials at B&B Herbold and Swiss Polymera.

⁴⁰ Monochromatic (measures light intensity differential), bi-chromatic (measures light intensity and colour differential), polychromatic cameras (measures multi colour differential).

⁴¹ Systems reported to operate at up to 4 tonnes per hour for plastic flake, and up to 36 tonnes per hour for food applications.

to remove as many reject flakes as possible while minimising the number of acceptable flakes inevitably blown out of the stream at the same time.

Figure 29 Flake colour sorting systems



Buhler-Sortex unit



S&S unit

Two trials were performed at the Buhler-Sortex facility in the UK. The removal of CPET and other flake from a Clear PET stream using a SORTEX Z+ monochromatic sorter and the removal of coloured flake from a natural HDPE stream using a bi-chromatic version of the SORTEX Z+.

The input materials were highly mixed with up to approximately 30% being coloured flakes and the remaining 70% of the input was analysed to be clear PET flake.

Small black flakes within the trial sample were identified as PS/HIPS and CPET. The very small flakes were identified by the sorting unit, but were extremely difficult to eject by the air valves. This reduced the ejection efficiency because the air valve also removed a high proportion of the clear flake. The ejected flakes were re-circulated but yield losses in the reject stream were still significant.

The results obtained in sorting the float stream were better than the sink stream as there weren't the same number of small black flakes present, however, due to the fact that the overall flake size distribution was not uniform enough, the final product purity was not considered to be acceptable.

The overall results clearly showed that it is essential to provide modern colour flake sorters with flakes of a relatively uniform size. The Sortex results may have been significantly improved if the very small flakes (<2.8mm) were removed by a sieving process prior to colour sorting.

The trials at SEA Srl and S+S included an initial sieving step to remove flake smaller than 4mm and 2.8mm respectively. This revealed that 17% of float fraction and 40% of sink fraction was the undersize flake. The following trial results were observed.

Figure 30 Colour separation trial results and pictures

Sorter/ flake type	SEA (mono-chrom.) / float fraction		S+S (full colour) /float fraction		S+S (full colour)/sink fraction	
	Colour content	Yield per pass	Colour content	Yield per pass	Colour content	Yield per pass
Input	48.5%		36.5%		25%	
Pass 1 accept	14%	45%	7%	34%	5%	55%
Pass 1 reject	76.8%	55%	52%	66%	49%	45%
Pass 2 accept	3%	48%	4%	89%	1%	90%
Pass 2 reject	40%	52%	31%	11%	37%	10%
Pass 3 accept	1%	77%	N/A	N/A	N/A	N/A
Pass 3 reject	10%	23%	N/A	N/A	N/A	N/A



3rd pass clear PO flake from SEA Srl trial (99% purity)



3rd pass coloured PO flake reject from SEA Srl trial



2nd pass natural HDPE from S+S trial (96% purity)



2nd pass Clear PET from S+S trial (98.76% purity)

The trial data demonstrates that colour sorting technology can achieve high separation levels. A single S+S unit with a designated recirculation channel can produce HDPE milk bottle rich flake that has a purity of approximately 96% with the remaining 4% primarily white flake. The separation of the sink fraction through the S+S unit produced a purity of 98.76%. The SEA Srl trial recovered natural PO flake to an acceptable purity of <1% coloured content after 3 sorting passes.

The efficiency of the sorting improved as the number of wavelengths was increased from mono-chromatic to bi-chromatic to full colour. The yield is affected by the ratio of colour to clear flake, with a greater mix requiring more sorting passes to achieve acceptable purity. The results were substantially improved by the use of pre-treatments that removed lighter films and smaller flakes. For both of the sink and float fractions separated by the mechanical recycling steps, it was possible to achieve high levels of colour purity in two to three passes through the sorter.

8.3.3 Dry cleaning of flake

The Pla.To dry-cleaning process removes surface dirt and paper labels from plastics without the use of a water washing process. The Pla.To mechanical purifier separates the waste dirt and heavy fraction from a plastic flake stream. Inside the mechanical purifier fast rotating blades create a high energy motion that subjects the plastic particles to rapid mechanical stress and deformation. Paper and surface dirt is broken down and removed through a cleaning mesh.

Figure 31 Pla.To mechanical purifier⁴²

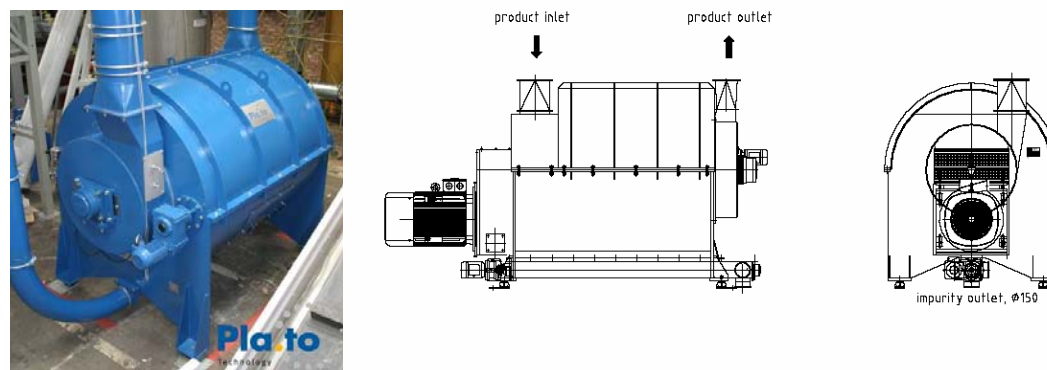

A number of trials were conducted including mixed plastic flake, dirty flexible film flake, and sorted PP and PET flake. Samples were batch washed before and after the dry-cleaning process. A weighed amount of the material was stirred in hot water and then the insoluble, clean plastics were removed and dried. The results of this cleaning efficiency test are shown below in table 10.

Table 10 Dry cleaning efficiency test results

Description	Weight before washing	Weight after washing	% loss
	gram	gram	
Input rigid flakes	47.5	37.0	22%
Output pass 1	40.1	35.5	11%
Output dirt/ paper	48.75	7.57	84%
Output 2nd pass	61.36	59.72	3%

The input plastic flake sample had approximately 22% by weight of dirt/paper material. The first pass through the dry-cleaner machine reduced the contamination to 11% and the second pass reduced this to 3%. The reject sample was subjected to the same test to see how much of the waste material was plastic-fines (or insoluble material). This shows that at least 84% of the waste fraction was paper or soluble dirt and it is assumed that the rest is plastic fines that had passed through the screen during the trial.

A similar test on the dirt fraction collected from the trials on flexible PE films showed that 22–40% of the 'dirt/fibres' material was plastic fines which were insoluble in water. This does represent a loss of fine plastic 'dust' into the waste, reducing yield of cleaned material. However, it should be noted that the trial was conducted with a larger screen-hole size than normally recommended due to the dirty nature of the rigid sample.

The system successfully removed paper and dirt from a heavily contaminated sample of 200 kilos of flaked mixed rigid containers. Two passes through the machine were needed to remove the very high levels (circa 50%) of wet paper and surface dirt seen in the material. A smaller quantity of undesirable heavy particles of metal and glass were removed via a separator section in the pneumatic infeed to the dry-cleaning unit.

⁴² Diagrams provided by Axion.

A sample of 100 kilos of dirty flexible film flakes of 40mm particle size was also processed and 10 kilos of dirt was removed. The machine was also used to process two smaller samples of rigid container flakes which had been positively sorted using an NIR system.

Figure 32 Examples of Pla.To dry cleaned flake



Dry cleaned rigid flaked PP from NIR sorting



Dry cleaned rigid flaked PET from NIR sorting

A throughput of 3 tonnes per hour is quoted for the largest Pla.To machine handling dirt contamination levels of 10-15%. The higher levels of contamination in domestic plastics packaging will lead to lower throughputs due to the increased contamination levels. Throughputs for flexible films are also lower due to the much higher surface area to mass ratio. Approximately 1 tonne per hour throughput would be expected for this type of material with 10-20% input dirt levels.

The Pla.To dry-cleaning process achieves a removal of surface dirt and paper from flakes of both rigid and flexible plastics without the need for a water washing process. While it cannot cope with excessive contamination, it may offer a solution for the pre-treatment of flake for a washing plant, or as a post shred cleaning function before sale to market.

9.0 Investment appraisal of Recycling Mixed Plastics Packaging

The investment appraisal involved two activities: an initial review of equipment capital and operating costs to support process design development, followed by more detailed consideration of several pieces of equipment put together in three complete process designs.

9.1 Investment appraisal approach

A total of eleven modular technologies were considered, covering four generic processes:

- 1 Separation of flexible (film) and rigid elements of in-feed material.
- 2 Separation of rigid components by polymer type.
- 3 Flake separation.
- 4 Dry cleaning.

Table 11 Summary of technologies and equipment reviewed

Process type	Equipment reviewed
a) Separation of flexible (film) and rigid (container) material from mixed input.	<ul style="list-style-type: none"> ■ Stadler STT2000 Ballistic Separator. ■ KME Air Drum Separator.
b) Separation of rigid material by polymer type.	<ul style="list-style-type: none"> ■ Pellenc MISTRAL 1200. ■ QinetiC demonstrator system. ■ Titech Autosort MF.
c) Flake separation.	<ul style="list-style-type: none"> ■ B&B 'Dry' Cleaning (TR100/200 T/V), Hot Wash (HWK1200) and Separation (FA60/190-2S + TR15/30) System ■ Flottweg Sorticanter. ■ Herbold – Washing & Hydrocyclone Separation Unit. ■ Swiss Polymera – Pre-Treatment line. ■ TLT Process.
d) Dry cleaning.	<ul style="list-style-type: none"> ■ Pla.To – Mechanical Dry Cleaning System (MR110).

Process costs were reviewed on the basis of information provided by the manufacturer or agent and additional information collected during the trials. Financial modelling of processes used the following process specific information:

- 1 Process Input: UK sourced, mixed non-bottle fraction plastics, including film, or, container fraction derived from this, or pre-separated film or rigid (container) fractions derived from mixed domestic plastics packaging.
- 2 Process input (tonnes/hour).
- 3 Output streams produced.
- 4 Equipment capital cost (including installation and requisite ancillary equipment, where possible).
- 5 Equipment power rating (maximum - kW and loading during operation %).
- 6 Water consumption (m³/hour).

- 7 Other consumable costs (£/tonne input).
- 8 Labour requirements.
- 9 Spares and maintenance costs (% of capital cost/year).
- 10 Operational floor area requirement.

Process costs were modelled using a bespoke finance model, in order to estimate processing costs per tonne of input material for generic operations and this information was then used to support development of process designs which were modelled in more detail.

Estimated process costs are not presented as stand alone costs, because the scale of equipment and level of detail provided varied between manufacturers so the costs derived would vary and would be potentially misleading. Process costs are considered in more detail in section 11.

9.2 Plastic markets and values

A key factor in determining the feasibility of sorting mixed plastics packaging for recycling is the value of the output fractions. This will ultimately determine if sorting mixed plastics packaging can be a financially viable activity when compared to alternative waste management options.

An overview market assessment was completed⁴³ using information supplied by plastic reprocessors and agents based in the UK and Europe. Market values were provided for a variety of possible sorted plastic streams. The values provided in Figure 33 below are based on UK ex-works prices.

Figure 33 Reported value ranges for sorted plastic fractions from domestic waste stream

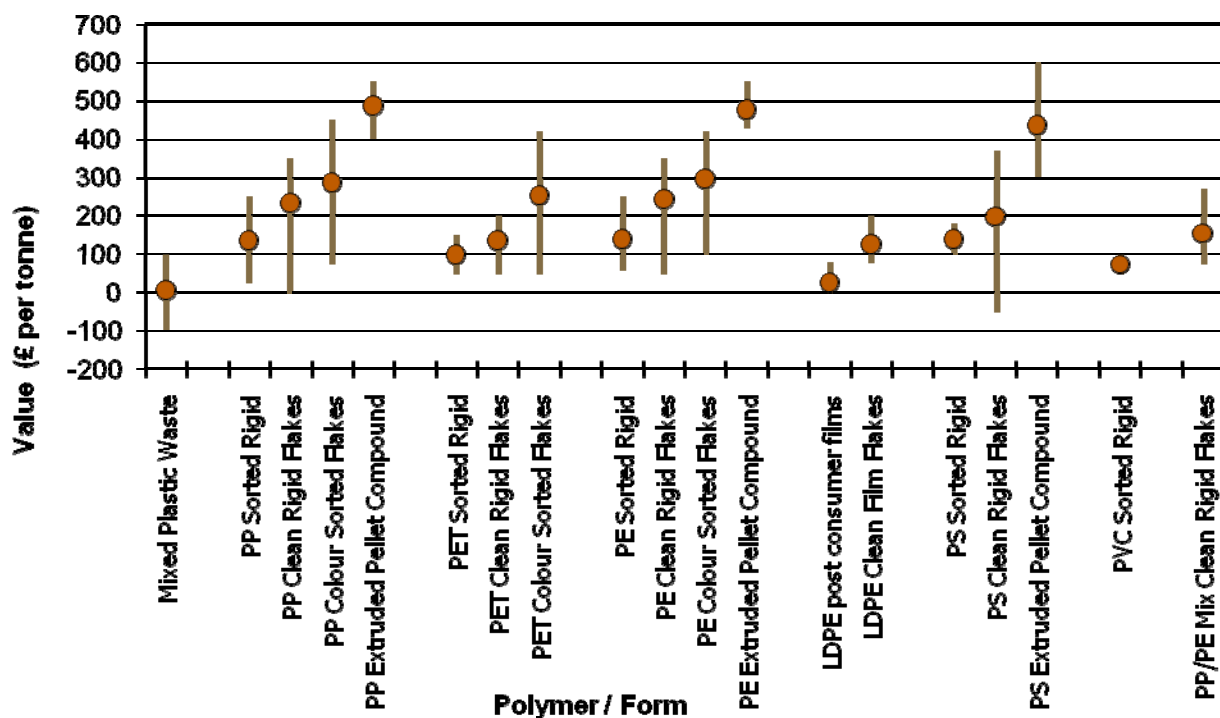

The data demonstrate the variation in perceived market values particularly for flake and pellet. The wide value ranges provided are likely to be a result of the cautious approach for the market to applying a specific value to a fraction that is not currently available for large scale testing. Further sampling and testing of plastic flake from domestic packaging sources by UK plastic reprocessors would allow the material specification and value ranges to be refined.

Indicative market data for selected flaked and pelletised plastic was also obtained from reputable European sources as shown in figure 34. This provides a much closer value correlation for the purposes of developing process designs with flake and pellet outputs.

⁴³ Overview market assessment completed by Axion : values confirmed by email 4th April 2008

The investment appraisal used UK market values where markets exist in the UK, and European market values for the other relevant polymer fractions where markets are not yet developed in the UK. It is clear that higher market values will be achieved by producing an extruded pellet. However, the financial viability of the process designs will depend on the value added exceeding the related process costs to provide a financial margin. This is explored further in subsequent sections.

Note that the values were obtained during a period of relatively high crude oil and virgin polymer prices (March 2008), and may therefore be higher than 'historic average' prices (figure 35). Recovered polymers are generally traded based on a percentage of the virgin material price. So fluctuations in crude oil and virgin polymer prices may affect the ongoing values of the plastic output streams from the sorting processes identified in this report and will influence the viability of the sorting activities.

Figure 34 Indicative European values for flaked and pelletised plastics (from three market sources).

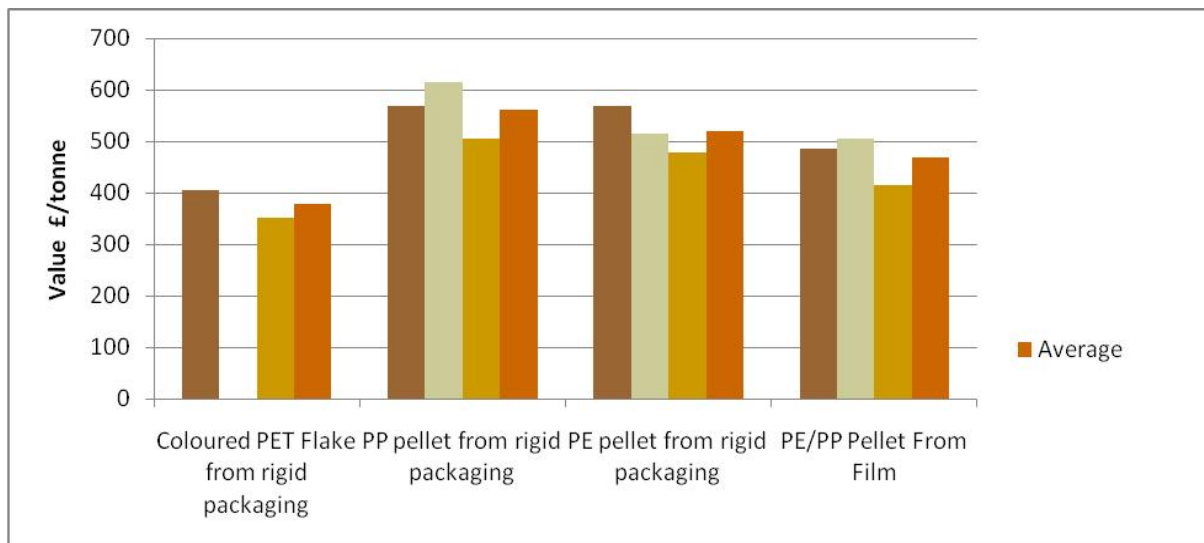

Plastic packaging recovery notes (PRNs) provide a further potential source of revenue⁴⁴. PRNs can be issued where the plastic packaging is processed through an extrusion process. PRN prices have been fairly stable over the past 12 months at around £15 per tonne. However, given the high degree of uncertainty about output materials prices, PRN revenues have not been explicitly included in the modelling exercise.

⁴⁴ Packaging export recovery notes (PERNs) are subject to the same market values and may be issued when plastic packaging is exported.

Figure 35 Graph illustrating link between crude oil, virgin polymer and recovered polymer prices⁴⁵.

Crude oil and virgin polymer prices
£ per tonne/barrel

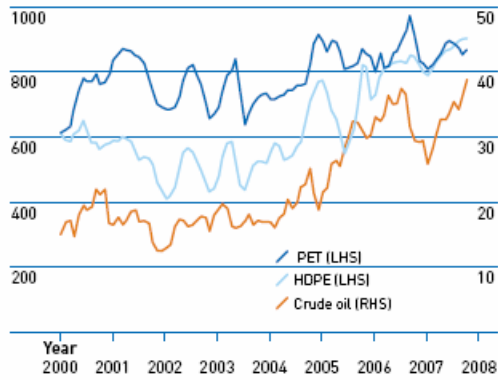

Sources: www.pieweb.com, EIA and Bank of England.

Virgin and recovered polymer prices
£ per tonne

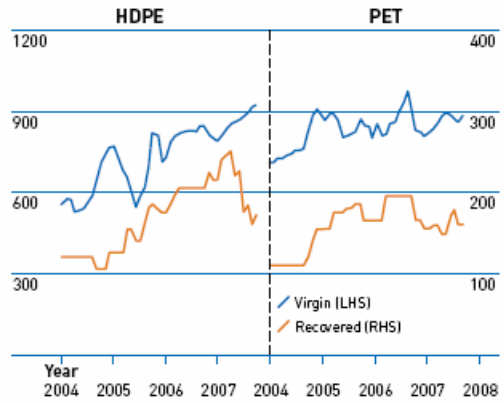

Sources: www.pieweb.com, MPR and Bank of England.

⁴⁵ WRAP Plastic Market Situation Report – Autumn 2007: Realising the value of recovered plastics.

10.0 Environmental Lifecycle Assessment and Benchmarking of Recycling Technologies

This section of the report provides an overview of the environmental LCA study completed for the trialled sorting technologies and includes comparison with a selection of alternative disposal options for domestic mixed plastics packaging. For more details refer to the full LCA report.

10.1 Introduction

The aim of the environmental LCA was to identify whether domestic mixed plastics recycling has the potential to deliver significant environmental benefits over existing waste management options. The study will inform WRAP's strategic planning process and determine whether this should be a priority area for further work. It is expected that recyclers and other stakeholders will also find this assessment useful in shaping their decisions regarding technology options for managing domestic mixed plastic waste.

Trials of mixed plastic waste recycling technologies from a wide range of organisations have been carried out. Several alternative disposal/recovery technologies have also been assessed based on data obtained from published literature and life cycle inventory databases.

To enable a comparison to be made between the various technologies a series of scenarios have been developed to build up complete supply chains for the recycling process - each accepting the same mix of input materials. Where necessary, several technologies have been combined to produce a complete supply chain. These are described in table 12 below.

10.2 Functional unit

The basis for comparison between the various recycling technologies and alternative disposal routes is the recycling, reprocessing or disposal of one tonne of mixed plastics (and other residual materials) arising as waste from a materials recycling facility.

10.3 Study boundaries

This LCA relates only to waste management options for mixed plastics. An assessment of the potential effect of managing mixed plastics as part of a mixed municipal waste stream was outside of the scope of this study.

For each recycling scenario the boundaries of the LCA study range from the point at which this mixed plastic waste leaves the MRF through to the production of granulate material ready to be made into "new" products. Non-recycled fractions are modelled up to the point at which the material is considered to be disposed of (e.g. in landfill) or to the point where it can substitute for a primary material (e.g. after the agglomeration process for producing a redox agent for blast furnace injection). In the case of recycled/recovered products the assessment also includes the avoided production of material or energy from primary sources. It should be noted that the chosen study boundaries mean that the process of collecting the mixed plastic waste is not included in the assessment.

The technologies included in this study are either already in use in sorting facilities or have been proven in principle in pilot plants and could be scaled up and deployed in the near future. As such the study represents the current situation or that which could exist within the next few years. Geographically, the work aims to reflect the situation in the UK.

10.4 Impact assessment categories and relevant metrics

The following impact categories have been assessed:

- Global Warming Potential (GWP).
- Photochemical Ozone Creation Potential (POCP).
- Eutrophication Potential (EP).
- Acidification Potential (AP).
- Human Toxicity Potentials (HTP).
- Ozone Layer Depletion Potential (OLDP).

- Abiotic Depletion Potential (ADP).
- Primary Energy Consumption.
- Landfilled Solid Waste.

The priority issues for WRAP are GWP and solid waste arising.

10.5 Allocation procedures

A system expansion approach has been used to calculate the overall environmental performance of each option as follows:

$$\text{Environmental performance} = \text{Process impacts} - \text{Avoided impacts of primary production}$$

“Process impacts” relate to the environmental impacts from operating each waste management option. The “avoided impacts of primary production” are the environmental benefit derived by replacing the need to produce functionally equivalent products from primary materials.

Table 12 Key processes included in the modelled process options

Scenario	Key processes
A	■ Landfill (all materials).
B	■ Municipal incineration with energy recovery (all materials).
C	■ NIR sorting (Titech). ■ Conversion to SRF for cement kilns (non-PVC fraction). ■ Mechanical recycling of PVC fraction.
D	■ Film removal (Stadler). ■ NIR sorting of rigids (Titech). ■ Pyrolysis of PP and PE fractions (BP polymer cracking process). ■ Mechanical recycling of PVC and PET fractions.
E	■ Film removal (Stadler). ■ NIR sorting of rigids (Titech). ■ Pyrolysis of PP, PE and PS fractions (Ozmotech process). ■ Mechanical recycling of PVC and PET fractions.
F	■ Film removal (Stadler). ■ NIR sorting of rigids (Titech). ■ Conversion of PE and PP fractions for use as redox agent in blast furnace. ■ Mechanical recycling of PVC and PET fractions.
G	■ Film removal (Stadler). ■ NIR sorting of rigids (Titech). ■ Mechanical recycling of PE, PP, PET and PVC fractions.
H	■ Film removal (Stadler). ■ NIR sorting of rigids (Pellenc). ■ Mechanical recycling of PE, PP, PET and PVC fractions.
I	■ Film removal (Stadler). ■ NIR sorting of rigids (Qinetiq). ■ Mechanical recycling of PE, PP, PET and PVC fractions.
J	■ Film removal (Stadler). ■ NIR sorting of rigids (Sims). ■ Mechanical recycling of PE, PP, PET and PVC fractions.
K	■ Film removal (KME). ■ NIR sorting of rigids (Titech). ■ Mechanical recycling of PE, PP, PET and PVC fractions.
L	■ Film removal (Stadler). ■ Density separation (TLT). ■ Mechanical recycling of PE and PP fractions.
M	■ Sorting and cleaning PE and PP fractions (Swiss Polymera). ■ Mechanical recycling of PE and PP fractions (Swiss Polymera).
N	■ Sorting and cleaning PE and PP fractions (B+B). ■ Mechanical recycling of PE and PP fractions.
O	■ Film removal (Stadler). ■ Density separation (Herbold).

	■ Mechanical recycling of PE and PP fractions.
P	■ Film removal (Flottweg).
	■ Density separation (TLT).
	■ Mechanical recycling of PE and PP fractions.

10.6 Results

The summary figure below gives the overall ranking of each option against the impact categories assessed in this study. The priority given to each impact category is based on an assessment of WRAP's own targets and on the results of a normalisation exercise. Nevertheless, it should be recognised that all rankings of this type are based on subjective judgement rather than objective analysis.

Figure 36 Summary of results showing relative ranking of the scenarios against each impact category (rank 1 = best, rank 16 = worst / green = top 25%, red = bottom 25%)

Scenario	High priority ← → Low priority									
	GWP	Solid Waste	Energy	Human Toxicity Potential	Eutrophication Potential	Photochemical Ozone Creation Potential	Acidification Potential	Abiotic Depletion Potential	Ozone Layer Depletion Potential	
A (Landfill)	15	16	16	16	16	16	16	16	16	16
B (Incineration)	16	1	8	15	10	15	15	15	2	
C (SRF)	11	2	1	14	2	12	11	1	10	
D (BP pyrolysis)	14	12	4	2	8	13	13	14	3	
E (Ozmotech pyrolysis)	13	15	3	3	1	11	12	13	1	
F (Redox agent)	12	4	2	4	13	14	14	5	9	
G (Stadler & Titech)	1	5	5	5	3	6	4	3	6	
H (Stadler & Pellenc)	4	7	7	11	5	8	8	7	4	
I (Stadler & Qinetiq)	7	14	10	13	7	10	10	12	5	
J (Stadler & Sims)	2	6	6	6	4	7	5	4	7	
K (KME & Titech)	5	8	9	12	6	9	9	9	8	
L (Stadler & TLT)	6	10	12	8	11	3	2	6	11	
M (Swiss Polymera)	3	3	11	1	9	1	1	2	13	
N (B+B)	9	13	14	10	14	5	6	10	14	
O (Stadler & Herbold)	10	11	15	9	15	4	7	11	15	
P (Stadler & Flottweg)	8	9	13	7	12	2	3	8	12	

From this table it is clear that scenario A (landfill) is the option with the least favourable environmental performance followed by B (incineration) – although interestingly incineration has the best performance for solid waste arising, the second ranked impact category. The recycling scenarios (G–P) tend to have the best environmental performance if all impact categories are taken into account, but if the “WRAP priority impact categories” are studied then C (SRF) ranks in the middle of the recycling options.

Charts showing more detailed results for GWP and solid waste arising (WRAP's priority impact categories) are given below. When reading the charts, positive values signify negative environmental impacts arising from the recycling/reprocessing supply chain. Negative values signify an environmental benefit and are due to avoided processes (e.g. avoiding the need to produce primary plastic).

Figure 37 Net GWP (dark brown = recycling scenarios, light brown = alternative management options)

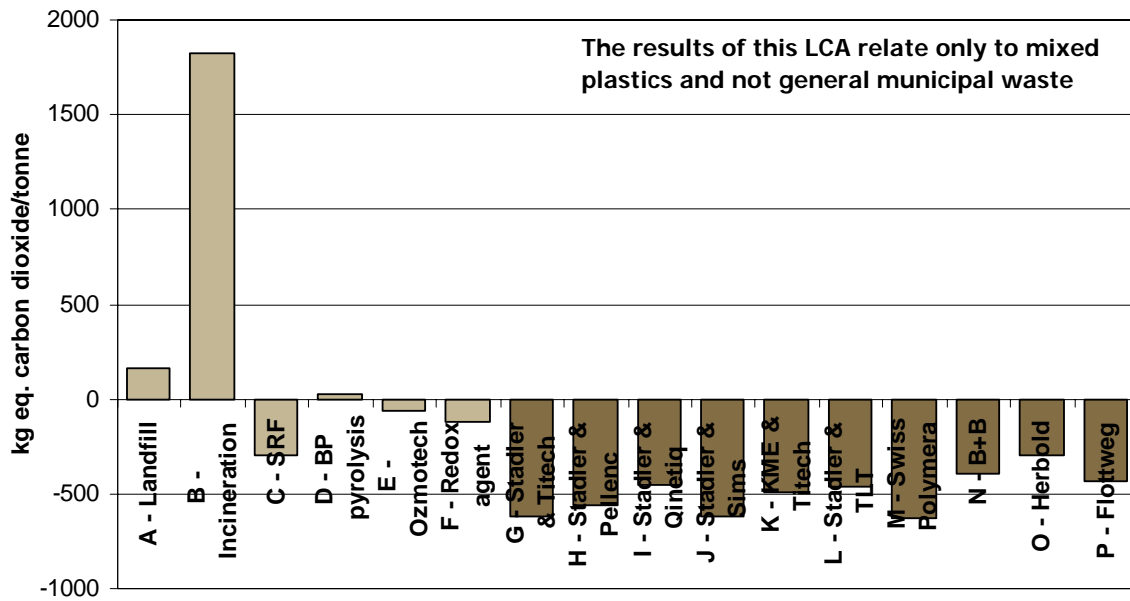
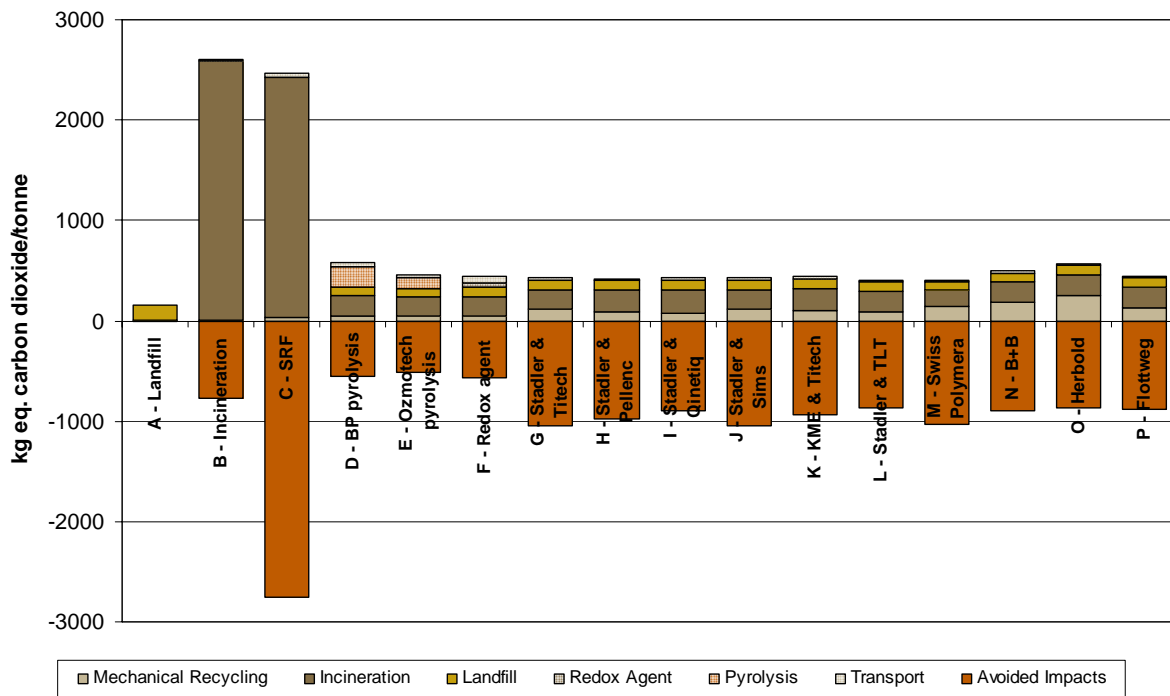
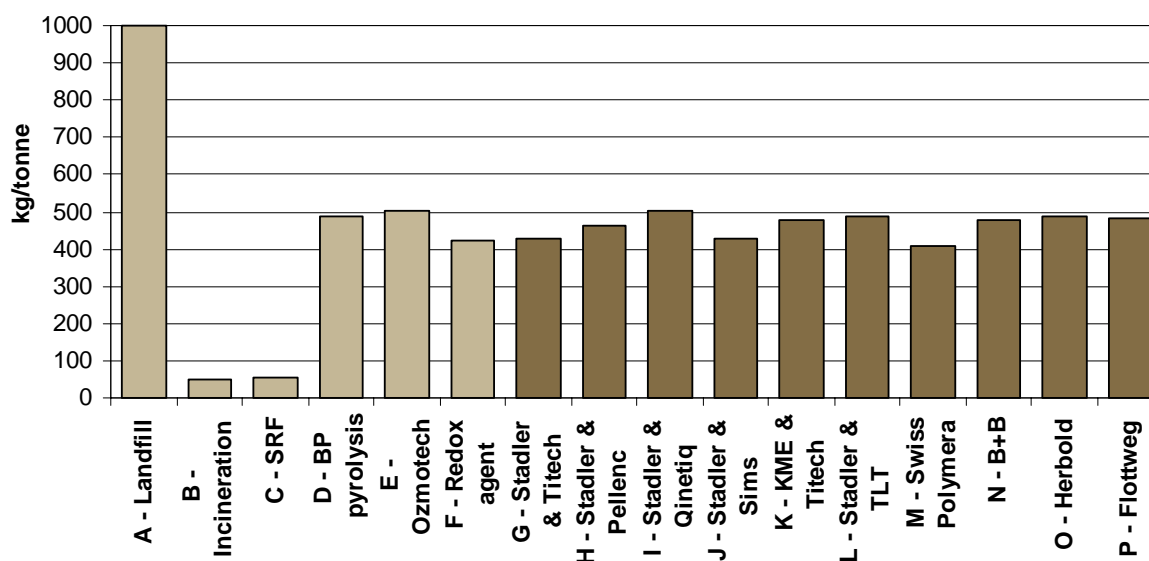

Figure 38 Contribution to GWP by process stage



The results in most impact categories are dominated by the avoided emissions from substituted processes, as can be seen in the chart above showing the contribution to overall GWP from each process stage. This means that even quite large differences in process impacts are often compensated by the even larger benefits from avoiding the use of primary materials.

Figure 39 Solid waste arising (dark brown = recycling scenarios, light brown = alternative management options)



The chart showing solid waste arising is given above. Landfill has the highest impacts in this category as expected, and the incineration scenarios (B and C) have the lowest impacts – plastic does not leave much residue when burnt. It is interesting that all the other scenarios (D–P) result in broadly similar quantities of solid waste despite the diversity of technologies involved.

The results relating to solid waste arisings are also interesting because they show that, for the individual recycling scenarios modelled, it is not possible to divert more than 60% of the material stream away from landfill. The same is true for the alternative reprocessing technologies, the exceptions being incineration and SRF to cement kilns (although the capacity of this latter option is limited in the UK). However, it should be noted that by combining recycling technologies to give a full process a higher proportion can be recycled. This can be seen in the results for the process designs (see later) where a 67% recycling rate can be achieved.

A series of sensitivity analyses have been carried out to test the importance of some of the main assumptions on the results. Aspects that have been looked at include:

- feedstock composition (low polyolefin, default and high polyolefin mixes);
- thermal conversion efficiency of municipal incinerators;
- choice of substituted power from municipal incineration; and
- choice of substituted material from recycling plastic.

The sensitivity analyses show that all of these aspects do affect the environmental performance of the various scenarios assessed in this study. However, the most important issue is shown to be the choice of substituted material from recycling plastic. The default assumption in the study is that recycled plastic will substitute directly for virgin plastic on a 1:1 basis. This implies that high quality recyclates are obtained every time. The chart below plots the effects on GWP when increasing quantities of lower quality plastic is produced that can only substitute for wood or concrete rather than virgin plastic. Once the amount of virgin plastic substitution drops below about 70% scenario C (the SRF scenario) becomes favoured over scenario G (a recycling scenario based in NIR-sorting).

Due to the inherent uncertainties in LCA the “absolute” values presented here should be treated with some caution and there is likely to be considerable variation around the 70% figure due to the specific assumptions and datasets in this study. Nevertheless, despite this uncertainty the general principle holds that the quality of the recyclates is a very important aspect affecting the environmental performance of the recycling scenarios and that

the best environmental performance is achieved when high quality recyclate is generated. If only lower quality recyclates are obtained then alternative disposal options may offer a better environmental solution. This principle also applies to the process designs developed in section 11.

Figure 40 Sensitivity of substitution options for recycled plastic packaging on GWP (comparison of scenarios C and G for varying degrees of substitution). Bands placed around each line to emphasise uncertainties in the data although these have not been quantified.

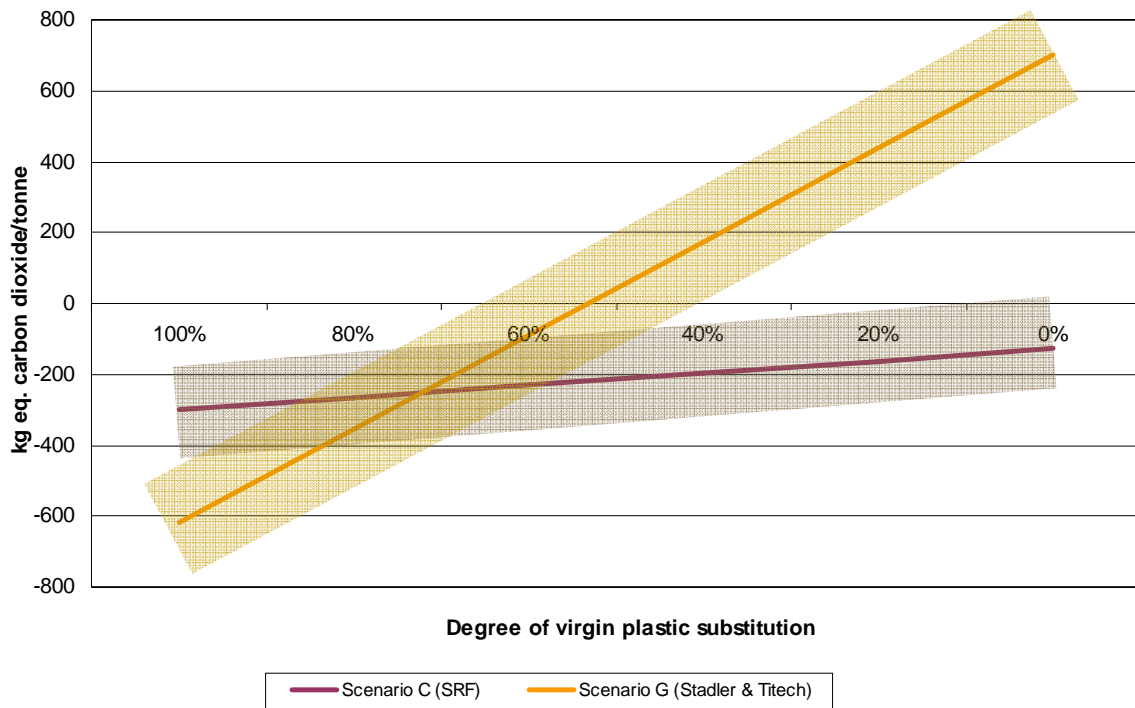

This clearly is a critical issue for understanding the environmental performance of the recycling technologies – if a large proportion of the input material cannot be recycled to sufficient purity to replace virgin plastic then the contribution to total GWP of the recycling process is likely to become greater than that of alternative reprocessing/disposal options.

The best environmental option will be to focus on developing facilities capable of delivering high quality recycled plastics that can substitute for virgin plastics. Where this quality cannot be achieved the material should be sent for use in alternative processing options such as SRF or for use as a redox agent in blast furnaces.

Figure 41 shows the results of combining uncertainties associated with incinerator efficiency and for substitution options for plastic recyclate and incinerator power generation.

Figure 41 Range of results for GWP when combining uncertainties associated with incinerator efficiency and for substitution options for power generation and recycling plastic packaging

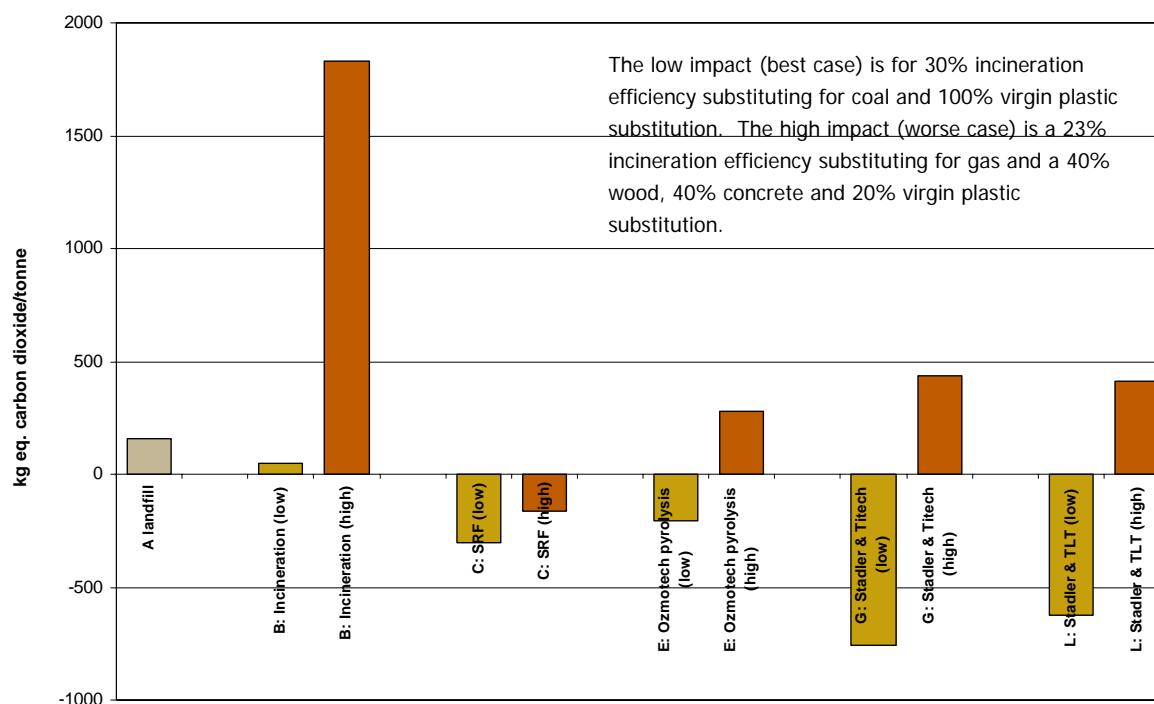

The majority of the variation for scenarios E, G and L is due to substitution options for plastic recycling (ranging from 100% virgin plastic substitution through to 20% virgin plastic: 40% wood: 40% concrete). While for scenario B the key factor relates to substitution options for power generation at municipal incinerators (natural gas power vs. coal power). Scenario C (SRF) is largely insensitive to the aspects being considered in this assessment.

The results show that there are possible scenarios where incineration becomes preferable to recycling – when incineration substitutes for coal power and recycling does not produce high quality plastic recycle. However, if it can be ensured that recycled plastic is of high quality then the recycling scenarios always have superior environmental performance to incineration for the GWP.

Overall, the results of this LCA indicate that recycling scenarios are generally the environmentally preferable options for all impact categories considered in this study and with the assumptions made. However, if one attempts to prioritise these impact categories and give more weight to the particular issues driving WRAP – GWP and solid waste – the results become more nuanced. The recycling options are favoured when considering global warming, but the EfW options (incineration and SRF) produce the least amount of solid waste.

Note; an assessment of the potential effect of managing mixed plastics as part of a mixed municipal waste stream was outside of the scope of this study.

For most of the impact categories studied, landfill is less favourable than incineration of mixed plastics. However, for GWP this study has found that incineration (with or without energy recovery) is the least favourable waste management option of those studied for domestic mixed plastics. On the basis of these results we can conclude that it is environmentally beneficial to remove mixed plastic from the waste stream prior to either landfilling or incineration. The diverted mixed plastics stream should be managed through a combination of mechanical recycling and SRF type processes.

No account is taken here of possible future changes in waste arisings. To do so would require the development of a series of future scenarios subject to their own uncertainties. Purely in the interests of transparency, therefore, the analysis is based around current conditions. However, it is still informative to consider how things may change in the future, as it reflects on the long-term robustness of the results. To illustrate:

■ Waste arisings:

- the amount of plastic packaging entering the waste stream will change;
- the variety of plastics packaging in the waste stream may reduce in response to the desire for recyclability;
- sorting speed and efficiency of technologies is likely to improve as they are utilised more widely; and
- the costs of these technologies will fall, again as experience with them increases.

■ Energy technologies:

- the marginal technology for power generation (currently gas-fired CCGT) may change, possibly to less carbon intensive fuel cycles such as nuclear or renewables;
- the efficiency of generation may improve; and
- in the medium to long term the fossil fuel cycles, as developed in the UK, may adopt carbon capture and storage, significantly reducing their greenhouse gas burdens.

■ Incineration:

- there may be an increase in the efficiency of incineration processes, particularly if the utilisation of waste heat becomes more widespread; and
- the demand for plastic packaging materials in incinerator feedstock may change in response to changes in the residual waste stream due to higher levels of recycling.

■ Availability of alternative processes for handling plastics packaging wastes:

- cement kilns and blast furnaces may not have the capacity to take a significant fraction of plastics packaging waste.

■ Environmental technologies:

- revision of the Large Combustion Plant and IPPC Directives may cause a reduction in emissions from various of the technologies considered in this report.

11.0 Process Designs for the Sorting of Domestic Mixed Plastics Packaging

This section uses the data to develop full process designs for the sorting of domestic mixed plastics packaging into marketable fractions.

11.1 Considerations for process design development

11.1.1 Input material

This project has identified that the definition and understanding of what constitutes 'mixed plastics packaging' varies greatly and there is only limited data on the composition of plastic packaging. The process designs have been developed to process all mixed plastics packaging sourced from the domestic waste stream only. This includes rigid and flexible plastic items of all polymer types and colours that are typically found in the home. The material also includes a small proportion of plastic bottles and residual waste. The data in figure 42 is based on information provided in section 5.4 of this report, and illustrates a representative input stream for process development.

Figure 42 Domestic mixed plastics packaging stream for process development (composition per tonne input)

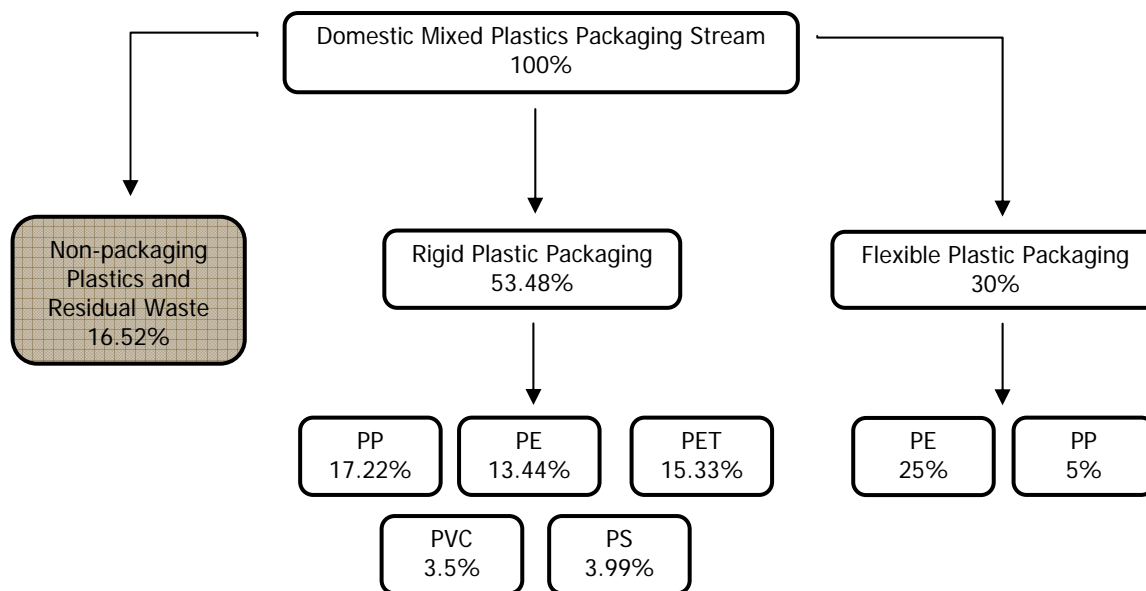

11.1.2 How the sorting process fits together

The four key sorting stages are film separation, whole item NIR separation, flake dry cleaning, and flake separation. A range of linking technologies are required such as pre-sorting, shredding and compounding to complete the process. Output material preparation is also required through the baling of whole items or bagging of rigid items.

The diagram in figure 43 shows the overview process options, and the flows of material through linked sorting technologies. This does not include additional items such as de-balers, QA stations or storage hoppers which will also be required for the process to function. These are considered later and in the economic and environmental analyses. Outputs are generated at each stage of the process, but do not necessarily have a positive market value. The marketable output fractions from this process are either baled or bagged for onward sale.

Figure 43 Generic sorting process with linking equipment

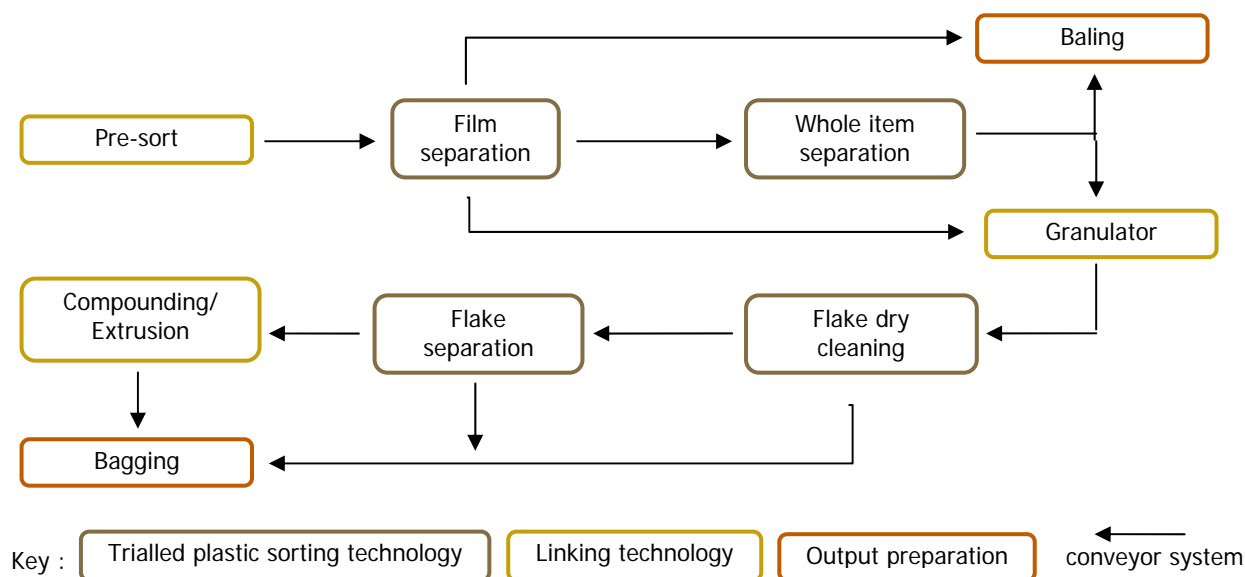

This generic process incorporates an initial pre-sort stage due to the common issue of contamination across a number of the sorting technology trials completed. It was reported from a number of trials that the level of contamination within the processed material affected technology performance, and the prior removal of contamination would allow separation systems to operate more efficiently. Operatives will manually remove non-packaging plastics and non-plastic items, paper and cans. If an excessive amount of metal cans are present within the input stream an overband magnet and eddy current separator could be added to the pre-sort stage.

Film separation is a standard first separation step when sorting mixed plastics packaging to avoid downstream issues. The significant presence of film in an NIR input stream can cover the rigid packaging which reduces the ability to accurately identify and eject individual rigid packaging items.

A bespoke film separation technology can run at up to six tonnes per hour with the option to bale and sell the output fraction directly to market. It is important to ensure dirty non-domestic film is not processed as the value of the output film stream will be reduced significantly or rejected by the reprocessor. The film fraction can also be shredded and processed through flake sorting systems to add market value.

The whole item separation will focus initially on a polymer sort using a single separation per machine. The number of units and the polymers sorted vary depending on the required output streams. The most common polymer types such as PP will be sorted first with each NIR system running at no more than three tonnes per hour. The unit will not identify black items which will remain in the residual fraction.

An appropriate granulator will reduce the size of whole items to approximately 15mm flake. This size flake is acceptable for all the flake sorting technologies tested. A proven industrial granulator will be selected for the process designs.

Dry cleaning will be used after the shredding stage to remove excess dirt and labels. Some applications can accept cleaned plastic flake from a dry cleaning process with some commercial operations extruding plastic directly after the dry cleaning stage. However, the aim of this study is to achieve a high market value so this step is used to allow the downstream technologies to function more efficiently. The system can achieve up to three tonnes per hour for rigid flakes, and one tonne per hour for film flake.

The float sink flake separation units will then be used to clean and further separate the polyolefin flake at a rate between 1 and 2 tonnes per hour. This will be fed into a compounding and bagging line to maximise output market value. The sink fractions from these processes will be sent for residual waste management.

Based on the market values obtained, it can be inferred that colour sorting to a high purity will increase output market value, particularly for the clear and natural fractions. But the separation performance of the flake colour

sorting technology was very dependent on flake size and input colour content (not measured in this project). Colour sorting of whole items could also be achieved using the NIR technology but this was not sufficiently tested within the parameters of this project. Given the particular sensitivity of these high market values to colour contamination and the need for further assessment of the potential colour sorting technologies, it was decided not to include colour sorting in the process designs at this time.

The removal of the higher value colours may negatively affect the value of the remaining colour output fraction. Having an accurate breakdown of input material by colour and accurate market values would allow this approach to be further researched.

Despite the inclusion of a pre-sort, a QA function must be included across the process to ensure material quality is not compromised and equipment is protected against damage from processing unsuitable items.

11.1.3 Output market fractions

A range of ex-works market prices were obtained from UK and European sources for the relevant process outputs. Average values were applied to the process designs and a sensitivity assessment completed. Further work is also needed since some of the sorted fractions such as non-bottle PET are sensitive to polymer variations with differing types of PET not automatically being compatible for reprocessing. For instance, PET bottle reproducers indicate that PET-G packaging is not acceptable at their facilities due to their different properties which will discolour and significantly reduce the reprocessed PET output quality and value.

Output material preparation would be needed, either through the baling of whole items or bagging of flaked or compounded product. Transport values can vary greatly depending on the location of the sorting facility, destination of the output fraction and the payload. Even an end market situated next to the processing site would require additional equipment such as hoppers and conveyors to transfer the material.

The amount of downstream processing has a significant effect on the material values. For this reason flaking and extrusion lines could be incorporated into the process to maximise output values. Flaking and compounding lines have not been included for the lower tonnage streams of PS and PVC.

11.1.4 Priorities for the process designs

The main priorities were to:

- Develop a realistic sorting process that was robust enough to handle expected contamination levels.
- Recover the highest percentage of mixed plastics packaging possible into positive-value sorted output streams.
- Focus on the most common polymer types including rigid PP, PE and PET, and also the PE rich film fraction.
- Achieve the highest quality outputs (although there were no exact market specifications to meet).
- Deliver justifiable payback terms on capital investment.
- Optimise the throughput efficiency of each technology in the process.

11.2 Recommended process designs

The recommended process designs are intended to demonstrate that domestic mixed plastics packaging can be sorted to a market specification in a financially justifiable and environmentally sustainable way, particularly when compared with alternative waste management options.

There are many variations that could be applied to the process designs, but the indicative approaches provided appear to represent the most likely solutions based on background research and technology trials. The three process designs developed are outlined below.

11.2.1 Process design A: film sorting and infrared sorting of whole items

Process design A incorporates the whole item sorting technologies with other required stages to produce polymer sorted output streams.

A de-baler allows baled or loose input material to be fed into a manual pre-sort cabin. This will remove non-packaging plastics and non-plastic items, paper and cans. A ballistic separator will then produce a film, rigid and fines output. The film will be passed through a QA cabin and stored for baling. The reject items from the pre-sort cabin, film QA and fines from the ballistic separator will be stored for residual waste management.

The remaining rigid mixed plastics packaging then enter a series of four NIR sorting units. The first two units remove PP and then PE. The third unit removes PET with clear bottles manually removed from the eject fraction. The final NIR unit operates a double positive eject of PVC and PS. The remaining material joins the residual waste line.

This approach incorporates a batch storage system with each output feeding into a single baler.

11.2.2 Process design B: film sorting and infrared sorting of whole items followed by flake sorting and compounding

The front part of process design B is the same as process design A described above. Each polymer output is then fed to a separate processing line with the material granulated and dry cleaned through a Pla.To system. The fluff and heavies fraction are stored for residual waste management, and the remaining cleaned flake is processed through a Herbold float sink cold wash system. The cleaned PET is bagged and sold as flake. The PP, PE and film fractions are further processed through a compounding unit to produce pellets. This adds value to the material before bagging and onward sale.

The process is also designed to accept baled, mixed or sorted plastic packaging material from third party facilities as an additional stream. This material could be sourced from any facilities with the relevant sorting equipment. It is required to allow the downstream flake processing technologies to achieve optimum throughput efficiency. Process design B assumes an additional 1.67 tonnes per hour of sorted plastics packaging is sourced.

11.2.3 Process design C: whole film sorting and flake sorting

Process design C takes a simpler approach to sorting mixed plastics packaging by using the flake sorting technology as the primary separation technique.

The initial steps are the same as process design A with a de-baler, manual pre-sort, ballistic separator and additional QA being used to produce all film (mainly LDPE) and clear PET bottle outputs, and also removing contamination. But instead of using NIR, the mixed rigid output is directly shredded, dry cleaned and fed into a float sink system. The resulting polyolefin output is compounded, bagged and sold. The heavy fraction is stored for residual waste management.

Table 13 Process design mass balance table by % output

Process design	Flexibles /Film	PP	HDPE	Clear PET Bottles	Coloured PET	PS	PVC	PO Pellet	Residual	
A	30%	16.35 %	12.77%	2.91%	11.65%	3.79%	3.33%		19.20%	100%
B	21%	15%	11%	2.91%	10.49%	3.79%	3.33%		32.48%	100%
C	30%			2.91%				29.13%	37.96%	100%

Figure 44 Process Design A

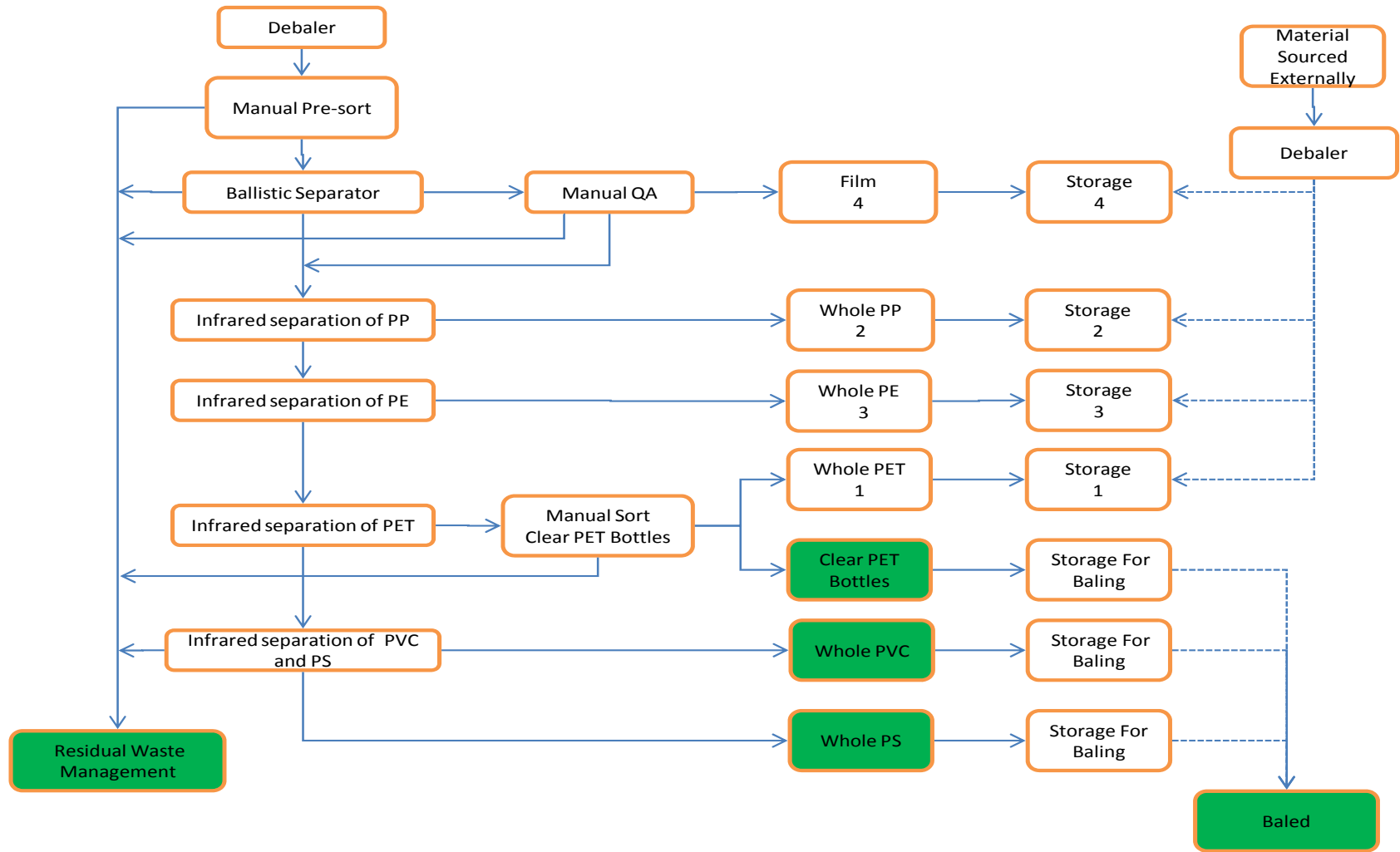

Please Note: For a stand alone system (not linked to Scenario B), the PP, PET, PE and FILM fractions could also be baled through the one baler

Figure 45 Process Design B

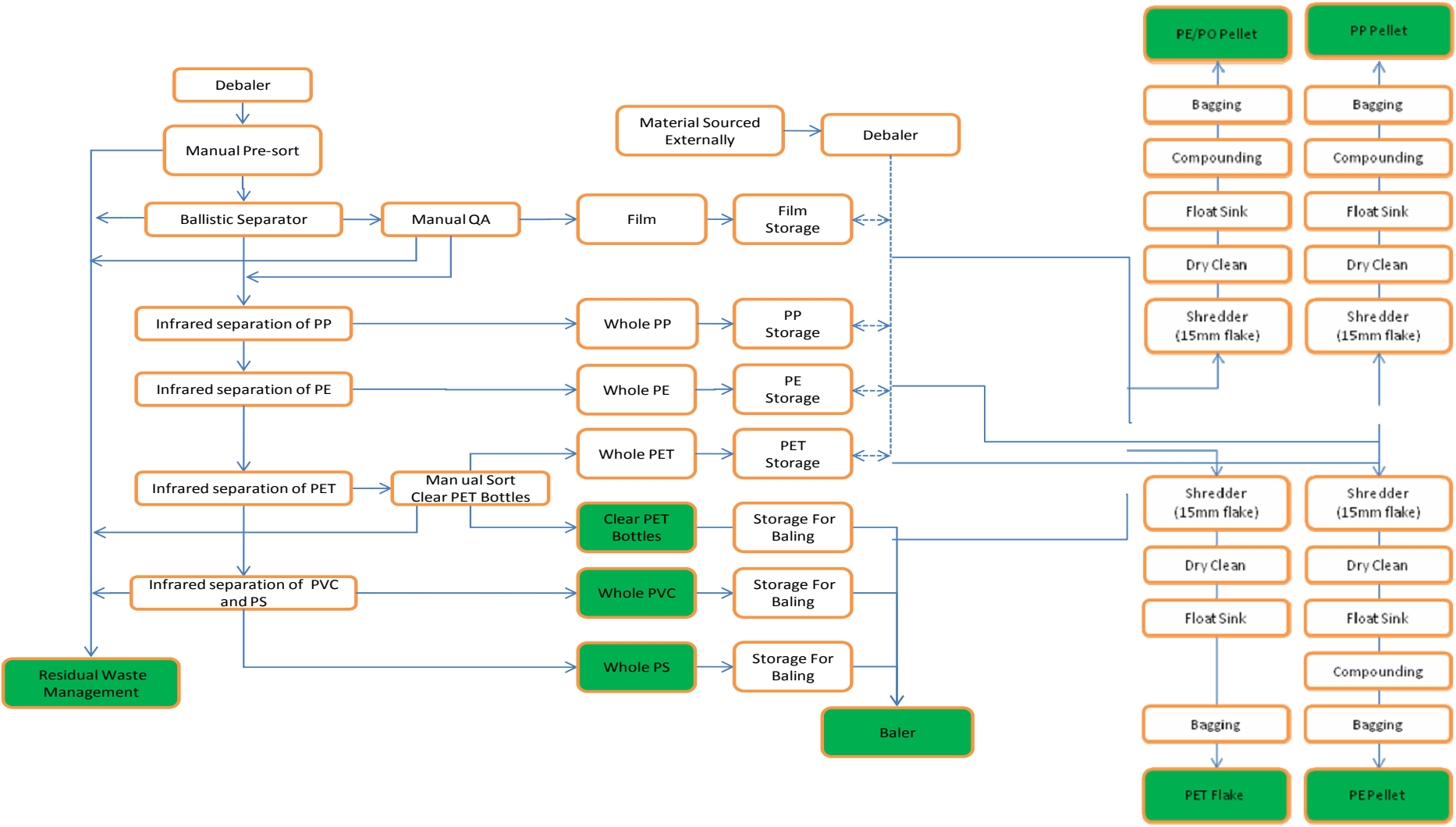
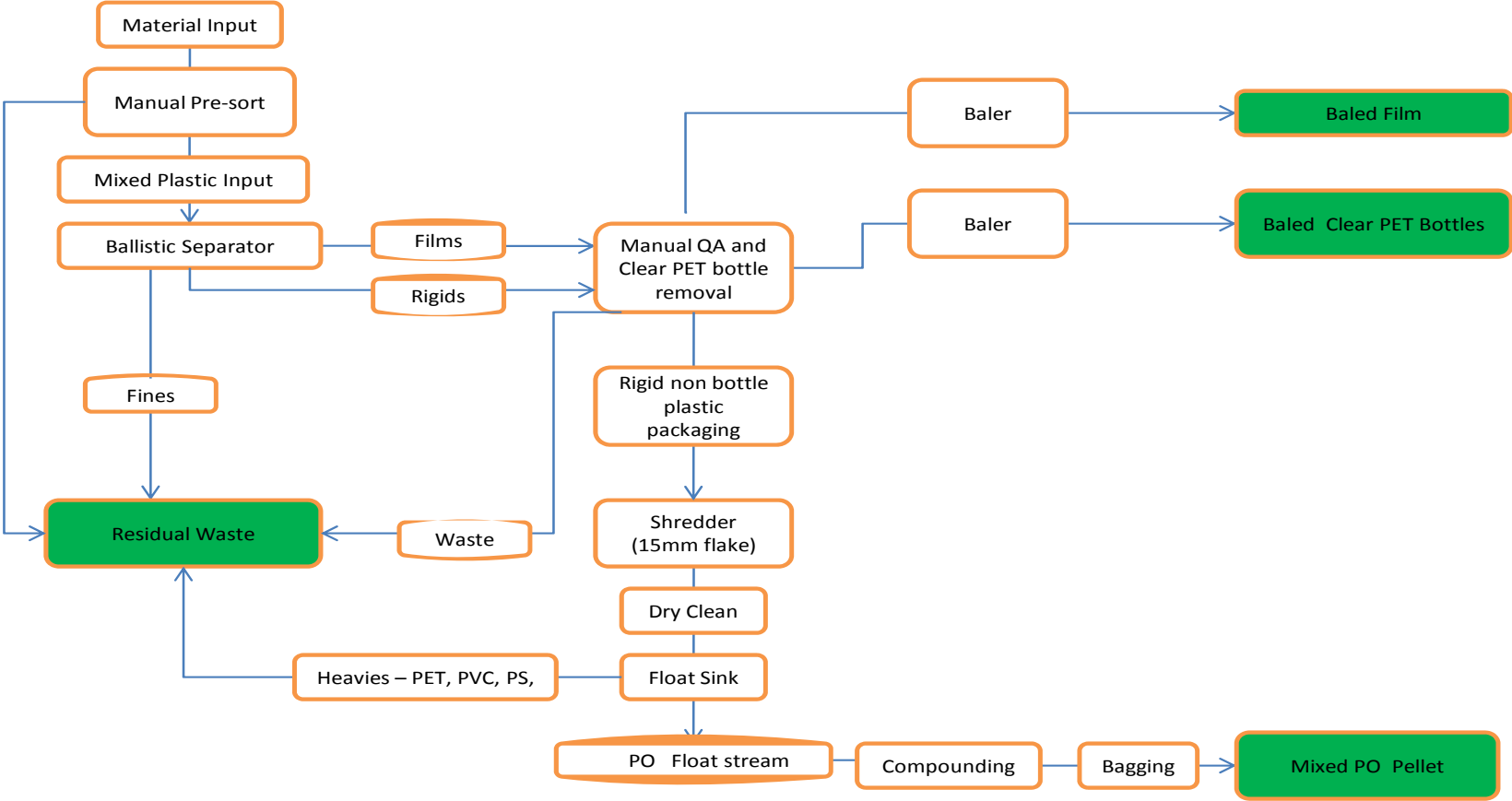

Figure 45 Process Design C



11.3 Process design review

The three identified process designs were reviewed based on practical, economic and environmental performance.

11.3.1 Recycling levels achieved

In terms of recycling outputs:

- Process Design A removes 4.85 tonnes of the 6 tonne per hour input stream for recycling (80.8%).
- Process Design B removes 4.05 tonnes of the 6 tonne per hour input stream for recycling (67.42%).
- Process Design C removes 3.73 tonnes of the 6 tonne per hour input stream for recycling (62.1%).

Process designs B and C show lower recycling levels due to additional cleaning of flaked material. They also assume additional downstream material input from external sources to achieve throughput efficiency across the process.

11.3.2 Preliminary assessment of the economic viability of the process designs

The economic viability of the three process designs were compared through an investment appraisal for each design involving analysis of the capital expenditure, operating cost and potential revenue. The review included three principal activities; estimation of capital and operational costs; review of market values for recovered materials; and developing an investment appraisal model for each process design. The key model outputs are cash flow profiles, internal rates of return, and sensitivity results.

The figures presented in this section constitute only a preliminary analysis of the economic performance of these processes. The results were based on a number of assumptions about market values, hours worked, asset utilisation, company structure and funding arrangements. As such, they should be regarded as indicative of relative attractiveness of each process, rather than actual potential investment outcomes.

Process designs were modelled based on the information in table 14. It was assumed that investments are made in 2008 with the plant becoming operational at the beginning of 2009.

Table 14 Information for process design modelling

	Process A	Process B	Process C
Equipment capital cost (£)	3,349,000	15,386,000	2,649,000
Process input	Household mixed plastics packaging ⁴⁶	Household mixed plastics packaging (plus additional pre-sorted material for further processing)	Household mixed plastics packaging
Process input tonnes/hour	6tph	6tph plus 1.96tph additional material ⁴⁷	6tph
Output stream #1	Baled flexible / film material	Re-compounded flexible / film fraction	Baled flexible / film material
Output stream #2	Baled PP	Re-compounded PP	Baled clear PET
Output stream #3	Baled HDPE	Re-compounded HDPE	Re-compounded PE/PP from rigids
Output stream #4	Baled PET (coloured)	Clean flaked coloured PET	Residual material
Output stream #5	Baled PET (clear)	Baled PET (clear)	
Output stream #6	Baled PVC	Baled PVC	
Output stream #7	Baled PS	Baled PS	

⁴⁶ All mixed plastic packaging sourced from the domestic waste stream. The input composition is detailed in section 5.

⁴⁷ Additional material (film, PP and HDPE) required to operate the extruders at capacity. These materials are purchased at market value.

Output stream #8	Residual material	Residual material	
Operational electricity requirement (kWh)	345	4,269	984
Water consumption (m ³ /hour)	0	8	1.95
Other consumable costs ⁴⁸ (£/hour of operation)	3	8	3
Labour requirement (per shift)	9 (7 unskilled, 2 skilled)	14 (10 unskilled, 4 skilled)	9 (7 unskilled, 2 skilled)
Spares and maintenance cost (% of capital cost)	3%	3% for elements common to process A, 5% for the other elements	3%
Operational floor area requirement (m ²)	3,150	6,850	3,300

The sales values of the materials for the base case are outlined in table 15. The prices are ex-works, with the exception of those shown in the lower part of the table which are delivered prices for the additional materials used in process B. The prices are derived from UK values where markets exist and European market values for the other fractions.

Table 15 Market values for recovered materials

	£ per tonne	Process A	Process B	Process C
Film (baled)	30	✓		✓
PP containers (baled)	125	✓		
HDPE (baled)	175	✓		
Clear PET bottles (baled)	150	✓	✓	✓
Coloured PET (baled)	100	✓		
PS (baled)	125	✓		
PVC (baled)	25	✓		
Clean coloured PET flake (bagged)	350		✓	
Extruded PE/PP pellet (bagged)	450		✓	✓
Extruded PP pellet (bagged)	540		✓	
Extruded HDPE pellet (bagged)	500		✓	
LDPE post consumer film	40		✓	
PP (sorted rigid)	135		✓	
PE (sorted rigid)	185		✓	

Table 16 presents a preliminary cash flow analysis under some base case assumptions for the three options. Key additional assumptions include: the reprocessor paying a fee for the mixed plastics feedstock, rather than receiving a gate fee; and a conservative assumption that the facilities operate for 260 days per year (rather than 312 days) giving an annual capacity of around 35,000 tonnes per annum.

The results are highly model dependant, but they suggest that both process B and process C could be commercially viable. In the base case scenario, processes B and C show payback periods of less than five years. By contrast, process A does not demonstrate a cash flow surplus under the base case assumptions.

⁴⁸ Other consumables includes process specific costs such as surfactants and bale wire.

Table 16 Cash flow profiles for the three process designs

Process A											
£ '000s	2008	2009	2010	2011	2012	2013	2014	2015	2016	2017	2018
Revenue		2620	2620	2620	2620	2620	2620	2620	2620	2620	2620
(less) Variable costs		2284	2336	2387	2387	2387	2387	2387	2387	2387	2387
(less) Fixed costs		271	271	271	271	271	271	271	271	271	271
Operating surplus		65	13	-39	-39	-39	-39	-39	-39	-39	-39
Capital expenditure		-3349									
Net cash flow		-3349	65	13	-39	-39	-39	-39	-39	-39	-39
<i>Memo: capital allowances (25% reducing balance)</i>			-837	-628	-471	-353	-265	-199	-149	-112	-84
Tax (30% rate)											
Net after-tax cash flow		-3349	65	13	-39	-39	-39	-39	-39	-39	-39
Process B											
£ '000s	2008	2009	2010	2011	2012	2013	2014	2015	2016	2017	2018
Revenue		14124	14124	14124	14124	14124	14124	14124	14124	14124	14124
(less) Variable costs		7643	7743	7843	7843	7843	7843	7843	7843	7843	7843
(less) Fixed costs		1074	1074	1074	1074	1074	1074	1074	1074	1074	1074
Operating surplus		5407	5307	5207	5207	5207	5207	5207	5207	5207	5207
Capital expenditure		-15386									
Net cash flow		-15386	5407	5307	5207	5207	5207	5207	5207	5207	5207
<i>Memo: capital allowances (25% reducing balance)</i>			-3847	-2885	-2164	-1623	-1217	-913	-685	-513	-385
Tax (30% rate)			-468	-727	-913	-1075	-1197	-1288	-1357	-1408	-1447
Net after-tax cash flow		-15386	4939	4580	4294	4132	4010	3919	3850	3799	3731
Process C											
£ '000s	2008	2009	2010	2011	2012	2013	2014	2015	2016	2017	2018
Revenue		4867	4867	4867	4867	4867	4867	4867	4867	4867	4867
(less) Variable costs		3148	3250	3353	3353	3353	3353	3353	3353	3353	3353
(less) Fixed costs		258	258	258	258	258	258	258	258	258	258
Operating surplus		1461	1359	1256	1256	1256	1256	1256	1256	1256	1256
Capital expenditure		-2649									
Net cash flow		-2649	1461	1359	1256	1256	1256	1256	1256	1256	1256
<i>Memo: capital allowances (25% reducing balance)</i>			-662	-497	-373	-279	-210	-157	-118	-88	-66
Tax (30% rate)			-240	-259	-265	-293	-314	-330	-342	-350	-357
Net after-tax cash flow		-2649	1221	1100	991	963	942	927	915	906	894

Figure 47 ranks the economic viability of the three process designs according to their post-tax internal rates of return (IRRs) across a range of prices paid for the mixed plastic packaging input material.⁴⁹

⁴⁹ The IRR can be used to rank several prospective projects a firm is considering. The IRR is defined as the discount rate that makes the net present value (NPV) of a project equal to zero. Generally speaking, the higher a project's internal rate of return, the more desirable the project. NPV is defined as the net value of future cash flows (i.e. revenue minus costs) discounted back to their present values (i.e. reflecting the time value of money). If a project has a positive NPV it should generally be accepted, whereas one with a negative NPV should be rejected.

Figure 47 Post-tax IRR for the three process designs

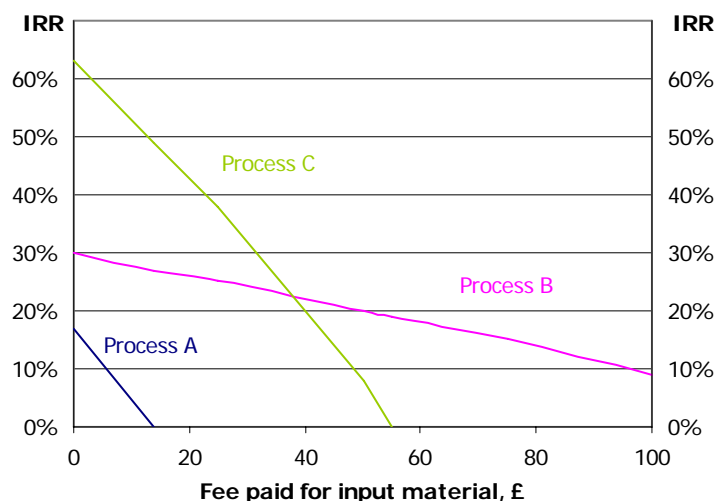

Again, processes B and C appear to be significantly more attractive than process A, and the spectrum of IRRs for these two process designs suggest that further economic analysis is warranted. The apparent lack of economic viability for process A highlights the commercial importance of adding value to recovered materials: process A primarily produces sorted baled materials whereas processes B and C produce re-compounded materials.

These results also demonstrate the importance of sensitivity analysis – it is clear from figure 47 that the economic viability of process C, in particular, is highly sensitive to the price the reprocessor has to pay for input feedstock. The primary reason is the relatively high loss rate from process C relative to process B, and the higher fraction of material going to low-value-added outputs.

Sensitivity analysis provides an indication of the robustness of the business being analysed. The lower the variability from the base case, the more robust and 'less risky' the business would be. Typical input variables to model in a sensitivity analysis might include sales prices, volumes sold, variable operating cost parameters (electricity, water, raw materials, etc) and changes on capital costs for various technologies.

One variable that the process investment returns are particularly sensitive to is the market value of the sorted materials. This affects sales revenues for each of the processes, and also variable costs for process B (owing to the additional material purchased to feed the extruders). A sensitivity analysis was undertaken for processes B and C. The range of prices used was +/- 25% of the prices used in the base case, which given the volatility in both virgin and recovered polymer prices seen in recent years seems relatively conservative. The results are summarised in figure 48.

Figure 48 Sensitivity analysis of rates of return to materials prices

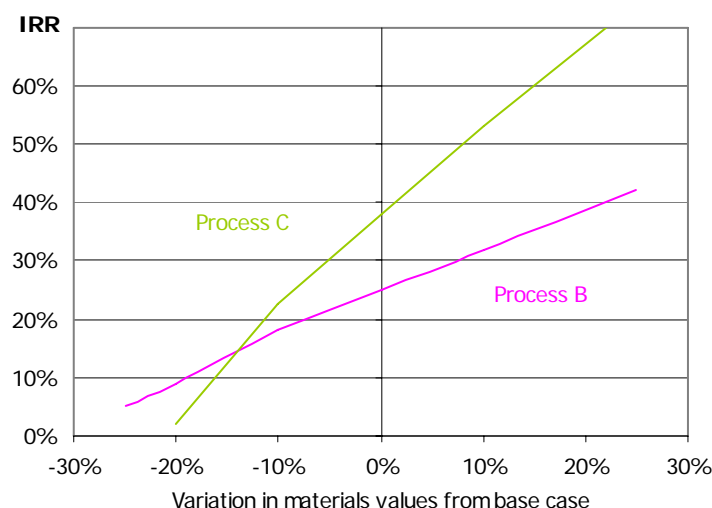

The sensitivity results show that for process B a 10% change in materials price translates into a 7% change in the IRR. Process C is significantly more sensitive to changes in materials prices: a 10% increase in prices leads to a 15% change in the IRR. The increased sensitivity of process C again reflects the relatively high loss rates and the significant fraction of material that goes to low-value-added outputs (i.e. baled post-consumer films).

Conclusion

On the basis of the analysis carried out and given the model assumptions, process B and process C both appear to generate attractive good internal rates of return. The sensitivity analysis suggests that process design B may represent a more robust option, albeit at a significantly higher capital cost.

11.3.3 Environmental benchmarking of process designs

Process designs B and C were benchmarked against alternative waste management options reviewed in section 10. Process design A has not been modelled as it was demonstrated to be unviable in the previous economic section. There are potential error margins within the process design LCA benchmarking due to variables such as input material composition and efficiencies of the sorting technologies.

Figure 49 provides a summary of the benchmarking for mixed plastics packaging recycling process designs against alternative waste management options.

Figure 49 Summary of results showing relative ranking of the process designs against each impact category (rank 1 = best, rank 16 = worst), (green = top 25%, red = bottom 25%)

Scenario	High priority					Low priority				
	GWP	Solid Waste	Energy	HTP	EP	POCP	AP	ADP	OLDP	
Landfill	7	8	8	8	8	8	8	8	8	
Incineration	8	1	7	7	5	7	7	7	2	
SRF to cement kiln	2	2	1	6	3	4	3	1	6	
BP pyrolysis	6	6	5	3	4	5	5	6	3	
Ozmotech pyrolysis	5	7	4	4	2	3	4	4	1	
Redox agent	4	5	3	5	7	6	6	3	5	
Process design B	1	3	2	1	1	1	1	2	4	
Process design C	3	4	6	2	6	2	2	5	7	

A closer look at the GWP comparison in figure 50 clearly shows that both process designs compare favourably with alternative waste management options. Process design B achieves -617kg eq. CO₂/tonne and process design C -236kg eq. CO₂/tonne.

Figure 50 Net GWP comparison – process design B and C

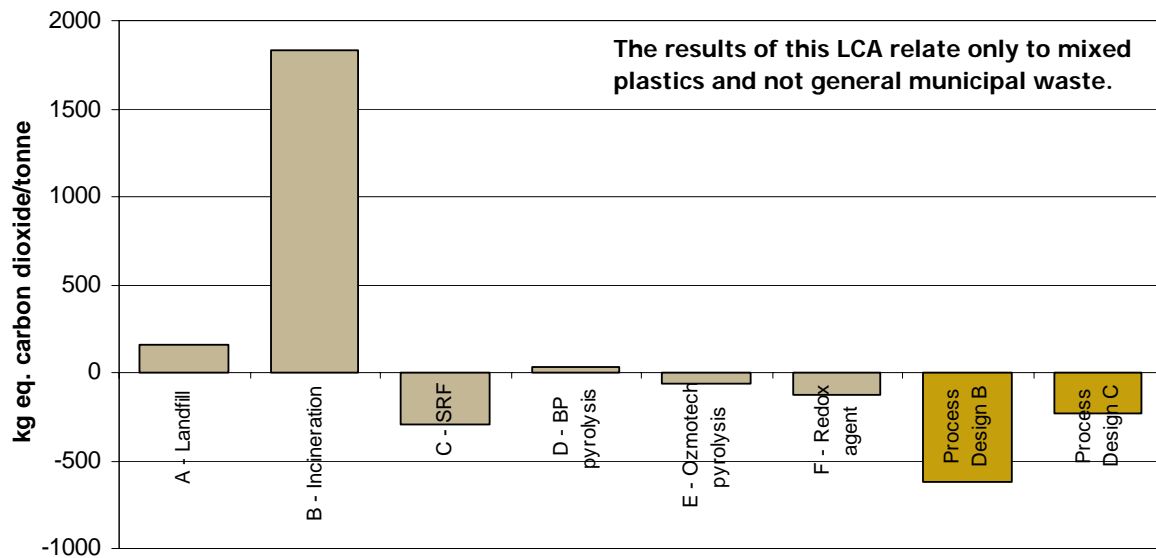

The comparison in figure 51 shows that incineration and SRF produce least solid waste. The process designs perform no worse than the other alternative waste management options in this category, and the solid waste could be reduced by ensuring no unnecessary waste is present within the mixed plastics packaging input stream.

Figure 51 Solid waste comparison graph - process design B and C

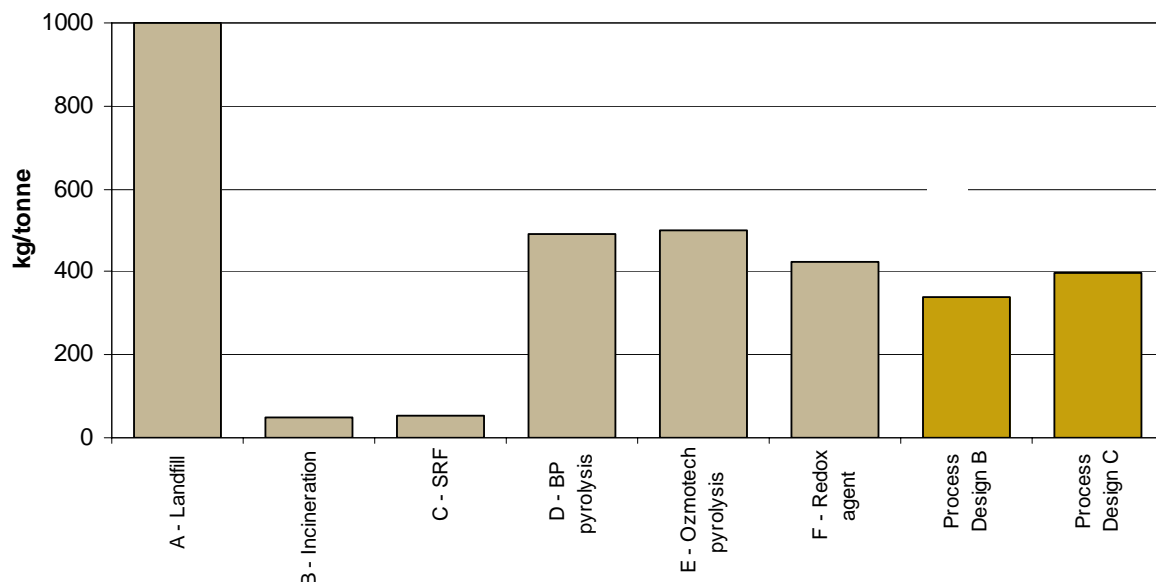

The environmental benchmarking data provides a good indication that process designs B and C are environmentally comparable with SRF and favourable to alternative waste management options when comparing

key indicators⁵⁰. An assessment of the potential effect of managing mixed plastics as part of a mixed municipal waste stream was outside of the scope of this study.

11.4 Process design summary and additional considerations

The three process designs have a potential capacity of 40,435 tonnes per annum of input material, although their financial viability has been assessed more conservatively and allows for some additional down time.

Process design A, which has a capital cost of £3.3 million, does not appear to represent a financially viable opportunity at the time of this study – in large part because insufficient value is added to the process material to justify payment for the feedstock.

Process design B facility has a capital cost of £15.4 million. It recovers 67% of plastics packaging from the input stream for recycling. For a 40,435 tonne per annum facility, this would translate into 27,261 tonnes of material and carbon savings of 40,000 tonnes⁵¹. Depending on model assumptions, the indicative IRR for process B is in the range of 10-30%.

Process design C incurs a capital cost of £2.6 million and recovers 62% of input material. For a 40,435 tonne per annum facility, this equates to 25,110 tonnes of plastics packaging and 37,665 tonnes of carbon savings⁵². The indicative IRRs for this facility lie in the range 0-60%.

There are a number of process considerations that could positively affect the performance of the proposed process designs:

- Process design B does not recover the black plastics which is estimated to be 5% of the input stream, and was observed as a significant fraction of the residual output from sorting trials. Composition assessments suggested 50% of the black plastics was PP with smaller fractions of PET and PS. The options would be to:
 - develop a separate flake sorting and compounding facility for the black plastics packaging where PP could be removed by float sink systems;
 - discourage use of black plastics by product designers and manufacturers; and
 - develop a low grade product using the mixed black plastics fraction.
- Process designs B and C focus on the common polymer types, with process design B removing PVC and PS to a whole baled output only, and process design C disposing of all non-polyolefin material except clear PET bottles. The options would be to:
 - develop separate flake sorting and compounding facilities for PS and PVC packaging;
 - discourage use of PS and PVC by product designers and manufacturers; and
 - develop technologies such as glycolysis to recover some of the process design C sink fraction.
- The film fraction in process design C is removed as an initial separation step into a baled format. There is an opportunity to feed the film through a float sink and agglomeration process. This could then be added to the rigid PO fraction for compounding thereby adding value to the film material.
- The residual content within the process leads to a less efficient process. Further work is needed to discover the balance point for residual content vs. financial justification.
- Colour separation will add value to the outputs, particularly for the clear and natural fractions. However, this may negatively affect the value of the remaining colour output fraction. Having an accurate breakdown of input material by colour and accurate market values would allow this approach to be further researched.

⁵⁰ GWP, solid waste arisings and primary energy requirement.

⁵¹ Reference point : Environmental Benefits of Recycling; An international review of life cycle comparisons for key materials in the UK recycling sector, WRAP 2006 section 3.4.1 : Plastic Main Findings.

⁵² Reference point : Environmental Benefits of Recycling; An international review of life cycle comparisons for key materials in the UK recycling sector, WRAP 2006 section 3.4.1 : Plastic Main Findings.

- General improvements in recycling technologies will affect the performance of the process designs, improving financial payback and reducing plastic content in the residual output.

12.0 Conclusions

This study has shown that mechanical recycling of domestic non-bottle mixed plastics packaging is technically feasible, and environmentally and economically sustainable. Preliminary process designs have been identified.

The study has also identified that the key risks to the development of mixed plastics recycling in the UK are:

- Availability of input material at the right market quality and price.
- Demand and price for the output plastic streams.
- Development of a process design which is attractive to investment.

12.1 Project conclusions

12.1.1 Process design conclusions

Two of the process designs considered were shown to be technically, environmentally and economically feasible.

The process design B facility incorporates the whole item sorting technologies to produce polymer sorted fractions. The PP, PE and PET are then shredded and separated using flake sorting technologies. The process is also designed to accept baled, mixed or sorted plastic material from third party facilities as an additional stream. The outputs include whole baled PS and PVC, cleaned flaked PET and compounded PP, PE and film. It recovers 67% of plastics packaging from the input stream for recycling. For a 40,000 tonne per annum facility this would translate into around 27,000 tonnes of material and carbon savings of 40,000 tonnes⁵³. The process design B facility has a capital cost of £15.4 million and indicative IRRs lie in the range of 10-30%.

Process design C utilises flake sorting technology as the primary separation technique, but still includes the initial removal of film. The mixed polyolefin output is compounded, bagged and sold. The heavy fraction is stored for residual waste management. The facility processes 40,435 tonnes per annum of input material. It recovers 62.1% or 25,110 tonnes of plastics packaging from the input stream for recycling which equates to 37,665 tonnes of carbon savings⁵⁴. Process design C incurs a capital cost of £2.6 million and the indicative IRRs for this facility lie in the range 0-60%. It must be noted that process design C is very sensitive to market fluctuations and is heavily reliant on one output stream.

The results of the financial modelling must be interpreted with some caution due to sensitivities around key parameters such output market values, electricity costs and the prices of oil and virgin plastic.

Process design B represents probably the most robust overall option as it is less sensitive to market fluctuations and has a wider range of outputs.

The effectiveness of these process designs may be improved by:

- recovering or removing the black plastics fraction from process design B;
- recovering or removing the PVC and PS from both process designs;
- process design C film handled through a float sink and agglomeration process, and blending with the PO;
- reducing the residual content within the input material;
- adding colour separation to flake sorting activity; and
- general improvements in sorting technology performance.

⁵³ Reference point : Environmental Benefits of Recycling; An international review of life cycle comparisons for key materials in the UK recycling sector, WRAP 2006 section 3.4.1 : Plastic Main Findings.

⁵⁴ Reference point : Environmental Benefits of Recycling; An international review of life cycle comparisons for key materials in the UK recycling sector, WRAP 2006 section 3.4.1 : Plastic Main Findings.

12.1.2 Technology trial conclusions

Individual technology trials demonstrated that:

- Film separation technologies are capable of achieving a high level of separation. The Stadler unit removed 99.5% and KME 97% of the film content from a mixed plastics packaging fraction.
- Film separation is an essential step in the plastics sorting process that ideally needs to be applied before rigid separation occurs. This will allow downstream sorting technologies to operate efficiently. This is particularly true for NIR sorting where significant amounts of film can cover the rigid packaging which reduces the ability to accurately identify and eject individual rigid packaging items.
- NIR systems can successfully identify and remove specific polymer(s) from a mixed plastics packaging stream achieving above 93% purity for all polymers except PS.
- NIR systems cannot identify black items which will subsequently stay in the residual stream.
- NIR systems can effectively remove PLA bioplastic and carton board from a mixed packaging stream.
- Separation of polyolefin plastics flake using a density separation technology can be very efficient. Assessment of the output purity demonstrated that four of the systems tested were capable of achieving at least 98% material purity.
- NIR technologies can sort a wider variety of plastics packaging, but flake density separation processes tend to recover a higher proportion of selected plastics packaging from the waste stream.
- The flake separation systems achieve cleaning and polyolefin separation in a single step, and can produce a high purity polyolefin stream which can be converted into a pellet for recycling or be used as a feedstock to plants that can use the mixed composition including pyrolysis into liquid fuels or waste to energy plants. Further tests are needed for specific polymer separation using base liquids.
- The sink fraction contains mixed polymers including PS, PET and PVC. The development of processes to separate the PET flake would allow the majority of this fraction to be recovered.
- Water separation systems cannot accept high levels of contamination with paper and carton board causing particular problems.
- Dry friction cleaning of plastic flake is a relatively inexpensive processing step that improves the efficiency of the water based flake sorting systems.
- Colour sorting technology can achieve high separation levels of 96% to 99% using two or three passes, as long as the input flake is of a relatively uniform size and the input colour content is known.
- The separation of polyolefins LDPE/PP/HDPE flakes into clear and coloured flakes can be reliably achieved if the colour concentration is not excessive (i.e. less than 25%). However, the value added may be minimal due to the properties of the mixed PO flake.

12.1.3 Recycling process financial conclusions

- The outline market assessment demonstrated wide value ranges and was completed at a time of relatively high crude oil and virgin polymer prices.
- The most significant element of income is the value achieved for recovered output materials.
- Maximum market value is achieved by incorporating downstream processing such as compounding.
- Lower market output values significantly affect the viability of the recycling process.

12.1.4 Environmental lifecycle assessment and benchmarking conclusions

- Overall, the results of the LCA indicate that recycling scenarios are generally the environmentally preferable option for all impact categories considered in this study and with the assumptions made. However, if one attempts to prioritise these impact categories and give more weight to the particular issues driving WRAP – GWP and solid waste – the results become more nuanced. The recycling options are favoured when

considering global warming, but the EFW options (incineration and SRF) produce the least amount of solid waste.

- The LCA relates only to the waste management options for mixed plastics. An assessment of the potential effect of managing mixed plastics as part of a mixed municipal waste stream was outside of the scope of this study. For most of the impact categories studied, landfill is less favourable than incineration of mixed plastics. However, for GWP this study has found that incineration (with or without energy recovery) is the least favourable waste management option of those studied for domestic mixed plastics.
- It is environmentally beneficial to remove mixed plastic from the waste stream prior to either landfilling or incineration. The diverted mixed plastics stream should be managed through a combination of mechanical recycling and SRF type processes.
- Once the amount of virgin plastic substitution drops below approximately 70% scenario C SRF becomes favoured over recycling. The quality of the recyclates is therefore a very important aspect affecting the environmental performance of the recycling scenarios. The best environmental performance is achieved when high quality recyclate is generated. If lower quality recyclates are obtained then alternative disposal options may offer a better environmental solution.
- The best environmental option will be to focus on developing facilities capable of delivering high quality recycled plastics that can substitute for virgin plastics. Where this quality cannot be achieved the material should be sent for use in alternative processing options such as SRF or for use as a reductant in blast furnaces.
- The results therefore show that no single scenario is likely to provide a complete solution. Rather, domestic plastics packaging recycling plants should be designed to produce high quality recycled material. Based on process design B, approximately two-thirds of the mixed plastics input would be mechanically recycled and the residual one-third would be managed by other options. This study shows that SRF would be the next favourable option.

12.1.5 Mixed plastics packaging trial material conclusions

The samples of mixed plastics packaging were sourced from UK sorting facilities. Depending on the collection and handling set up, the composition of the mixed plastics packaging varied greatly. As there is no direct recycling market for mixed plastics packaging, this fraction was usually included with the plastic bottle output stream, or mixed with the remaining waste fraction and landfilled. The key material conclusions from this study are:

- The indicative material split was 30% plastic films, 54% rigid plastics packaging and 16% residual waste.
- PP (17%), PET (15%) and PE (13%) were the most common polymer types found. Residual out-throw (16%) was the fourth major fraction within the samples.
- Combined PVC, PS and other fractions such as PLA accounted for less than 10% of the mixed plastics packaging samples.
- There were differences between the samples due to the natural variation in the material mix. Bottle content and residual content showed the widest variances within the samples provided.
- Contamination was observed in all mixed plastics packaging streams including non-packaging plastics and other recyclables. Most also contained some plastic bottles that had not been removed earlier in the sorting process.
- Pre-separation of residual waste from the input stream is necessary for all process designs to enable the sorting technologies to operate efficiently. This may include bottle removal and can separation. Alternatively the suppliers of material including MRFs and Local Authorities could be encouraged to improve the efficiency of their paper, can and bottle sorting, and potentially work to a standard mixed plastics packaging input specification or specifications.
- Perceived material quality appears higher when in baled form and can be significantly lower in quality when viewed after de-baling and whilst being fed into a process.

12.2 Main risks affecting feasibility of sorting domestic mixed plastics packaging

The main risks to the feasibility of sorting domestic mixed plastics packaging for recycling are:

a) Input material availability, quality and value

The input material is key. It needs to be collected in sufficient quantities to allow the installed sorting facilities to operate at capacity and the equipment to run efficiently at the highest throughput possible. The systems are designed to handle limited residual waste within a mixed plastics packaging stream, but if the residual content is too high, the pre-processing costs would outweigh the benefit of sorting mixed plastics. It will be necessary to ensure that residual content within a mixed plastic packaging stream is minimised through suitable collection systems, effective communication to householders, and adoption of good practice by waste collectors and primary MRF operators.

The value of the input stream must also be considered. The markets for mixed plastics packaging are currently very limited so this study has assumed that it will have no value and be landfilled at the current time. There may be alternative technologies such as plastic-to-fuel that use some form of mixed plastic stream as an input, and could also encourage positive market values to develop. Depending on demand and application, this may encourage a positive market price for the mixed plastic packaging. Recycling processes would need to compete for the material reducing profit margins.

b) Recycled output material value and demand

The value of the output fractions will dictate the profitability of the recycling activities. It will also drive which output fractions are viable to sort and which are not. This study was based on indicative market values that may need to be reviewed and updated. These values are linked to virgin polymer and crude oil prices which will change over time. The recent strength in virgin polymer prices has helped underpin the development of the UK's plastics packaging recovery infrastructure. However, with the outlook for economic demand weakening and significant expansions in petrochemical capacity expected there is an increased likelihood of virgin prices weakening, potentially affecting recovered plastic prices.

Irrespective of value, a large scale sorting facility will produce a range of output fractions and there will need to be a demand for these output streams from recyclers.

c) Technology performance

The trials completed for this study gave an indication of sorting performance, but this was based on relatively small samples. It may be necessary to complete further performance trials before developing a full facility. This would need to consider the composition of the input material and the throughput rates required. Even modest changes in output purity could affect market value, and different throughput rates will affect the efficiency of the process.

12.3 Developing UK domestic mixed plastics packaging sorting infrastructure: potential areas of further research

A range of areas of possible further research have been highlighted during the delivery of this study to inform UK mixed plastics packaging recycling infrastructure development. A number of the organisations involved in this study would advocate further research either before or alongside pilot facility development or capital investment programmes. These are listed below:

Collection and sorting systems

- Better understanding of existing mixed plastic packaging collection and sorting schemes. This would assess accurate tonnage arisings, mixed plastics packaging composition by polymer and colour, and routes to market and end use.
- Assessment of the process changes required to create relatively clean mixed plastics packaging streams from recyclables collections.
- Assess the affect of introducing mixed plastics packaging collections on existing domestic recyclables collection systems. This would be for actively promoted collection rather than passive recovery. Tonnage, quality, composition.

- Consideration of the impact of proposed mixed plastics packaging collection systems on existing separation and sorting infrastructure, and the new infrastructure requirements vs. suitability of existing facilities to be modified.
- Develop a good practice guide for domestic mixed plastics packaging collection and sorting.

Development of markets for output fractions

- Develop end market demand for the sorted fractions, specifications, work with recyclers.
- End market development.
- Work with UK reprocessors to define output specifications.
- Review existing recycled plastics markets. Assess the feasibility of purchasing mixed plastics packaging in comparison with other market options for potential suppliers. For example, if mixed plastics packaging is combined with plastic bottles and sold at a positive value, would this stream be secured by a UK mixed plastic sorting facility at no cost?
- Further research markets for heavy output fractions from float sink systems especially from process design C. This may include glycolysis of PET.
- Further research markets for the residual rigid black plastics from process design B.
- The further development of separation process for some of the more problematic combinations of flaked polymers, (i) HDPE and PP; and (ii) PET and PVC, would increase the amount of recoverable plastics.
- Feasibility studies conducted on processes and technologies that do not require the sink and float polymer mixtures to be separated any further. This may include developments in mixed plastic mechanical processing, pyrolysis and energy recovery for mixed polyolefins, and glycolysis for PET mixtures.

Other activities

- Consider the system impacts of reducing the number of polymer types entering the plant. The trials have demonstrated that all plastic fractions can be separated, but some only represent a small part of the mixed plastics packaging stream so it may not be economically feasible to do so. This may change with polymer pricing, plant scale and capital equipment costs.
- Monitor and engage UK mixed plastics packaging sorting facility developments.
- Develop a dedicated UK mixed plastics packaging focus group.
- Improve understanding of waste management option combinations as reliance on landfill is reduced. This may be completed using mass balance and financial assessments to highlight preferred combinations, and allow SRF and incineration to be considered alongside mechanical recycling.

Glossary

- ADP – Abiotic Depletion Potential.
- AP – Acidification Potential.
- BPEO – Best Practicable Environmental Option.
- EP – Eutrophication Potential.
- GWP – Global Warming Potential
- HDPE – High Density Polyethylene.
- HIPS – High Impact Polystyrene.
- HTP – Human Toxicity Potential.
- IRR – Internal Rate of Return.
- KPI – Key Performance Indicator.
- LCA – Lifecycle Assessment.
- LDPE – Low Density Polyethylene.
- MBT – Mechanical Biological Treatment.
- MRF – Materials Reclamation Facility.
- NIR – Near Infra Red.
- NPV – Net Present Value.
- OLDP – Ozone Layer Depletion Potential.
- PE – Polyethylene.
- PERNs – Packaging Export Recovery Notes.
- PO – Polyolefins.
- POCP – Photochemical Ozone Creation Potential.
- PP – Polypropylene.
- PRNs - Packaging Recovery Notes.
- PS – Polystyrene.
- PVC –Polyvinylchloride.
- QA – Quality Assurance.
- RDF – Refuse Derived Fuel.
- REACH – Registration Evaluation & Authorisation of Chemicals.
- SRF – Solid Refuse Derived Fuel or Solid Recovered Fuel.
- TPA – Tonnes per annum.
- TPH – Tonnes per hour

**Waste & Resources
Action Programme**

The Old Academy
21 Horse Fair
Banbury, Oxon
OX16 0AH

Tel: 01295 819 900
Fax: 01295 819 911
E-mail: info@wrap.org.uk

Helpline freephone
0808 100 2040

www.wrap.org.uk

