

UNCLASSIFIED

**Earth, Environmental and Life
Sciences**Lange Kleiweg 137
2288 GJ Rijswijk
P.O. Box 45
2280 AA Rijswijk
The Netherlands

www.tno.nl

T +31 88 866 80 00
F +31 88 866 69 49
infodesk@tno.nl**TNO report****TNO 2012 R10732****Evaluation of environmental and toxicity
monitoring methods during improvised 'burn
pits'**

Date March 2013

Author(s)

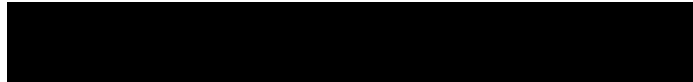

Copy no	
No. of copies	24
Number of pages	36 (incl. appendices)
Number of appendices	3
Sponsor	-
Project name	WP300 Omgevingsmonitoring
Project number	032.18518

All rights reserved.

No part of this publication may be reproduced and/or published by print, photoprint, microfilm or any other means without the previous written consent of TNO.

In case this report was drafted on instructions, the rights and obligations of contracting parties are subject to either the General Terms and Conditions for commissions to TNO, or the relevant agreement concluded between the contracting parties. Submitting the report for inspection to parties who have a direct interest is permitted.

© 2013 TNO

UNCLASSIFIED

Contents

1	Introduction	1
2	Experimental part	2
2.1	Test facility	2
2.2	First burn pit experiment, 30 March 2011	3
2.3	Second burn pit experiment, 11 May 2011	5
2.4	Description of the various monitoring methods	8
3	Results	14
3.1	General	14
3.2	Analysis of low molecular smoke gas components	14
3.3	Results of the Cascade Impactor	16
3.4	Volatile organic components (VOC)	17
3.5	Results of the on-line sensors	22
3.6	Result of the CULTEX [®] and TOXcontrol systems	24
4	Conclusions	27
5	References	29
6	Signature	30

Appendices

- Appendix 1
- Appendix 2
- Appendix 3

1 Introduction

In the course of WP300 of research program V1036 Military Toxicology, various methods have been developed for monitoring chemicals (releases, pollutants, combustion products, exhaust fumes, burning of waste etc) which might pose a hazard to military personnel during exercises and missions. These methods comprise both analytical chemical methods, as well as toxicity monitoring methods. In order to exemplify the utility of these monitoring methods, we selected a representative real-life scenario, i.e. a burn pit scenario. Emissions from the burning of waste in so-called 'burn pits' on military bases is one of the most common origin of chemical exposures. Burn pits have been used routinely throughout missions, because other waste-disposal options, such as incinerators, were often not available or operational.

We reasoned that the availability of experimental burn pit set up would form an excellent case study in order to test and validate our asset of methods for environmental monitoring. Therefore, the primary goals of the current study were:

- to establish the limitations of the various sampling and analysis techniques which we have developed in the course of research program V936,
- to find out which method gives the fastest response to toxic emissions from burn pits
- to evaluate which method is the best candidate for use under field conditions.

The secondary aim of these experiments was to explore the feasibility of a burn pit experiment under controlled conditions, for future studies aiming at risk assessment of burn pit exposures. Still much controversy exists around the potential risks of burn pit exposures and recently a US review committee recommended to perform additional research, e.g., not all chemicals had been identified and it had also not been taken account that exposures to mixtures of chemicals had occurred. (e.g., see report "Long-term Health Consequences of Exposure to Burn pits in Iraq and Afghanistan, 2011).

2 Experimental part

2.1 Test facility

The tests have been performed in the rocket test stand of the TNO research group Advanced Concepts & Products, located in Rijswijk, The Netherlands. The rocket test stand is a tunnel of approximately 30 m long, 4.5 m wide and 3.25 m high (see Figure 1). The tunnel is normally used for rocket engine testing and is therefore supplied with a strong air ventilation system and thorough heat protection. The air in the tunnel was refreshed by means of an air extraction system with an air flow of about 1.2 m/s. The air inlet has an open connection to the outside world. A similar set-up has also been used in examining the response of semiconductor sensors on exposure to single chemical components in an air stream.¹

At a distance of 3-4 m from the front of the bunker, a rocket mounting stand was used to position the blank samples. A distance of 5 m between the blank samples and the actual fire was kept to prevent unintentional contamination of the blank samples with smoke. At a distance of 16 m from the fire, all sampling and detection devices were placed on a table at a height of 1 m for the initial test.



S1 = Sampling location blank
S2 = Sampling location smoke

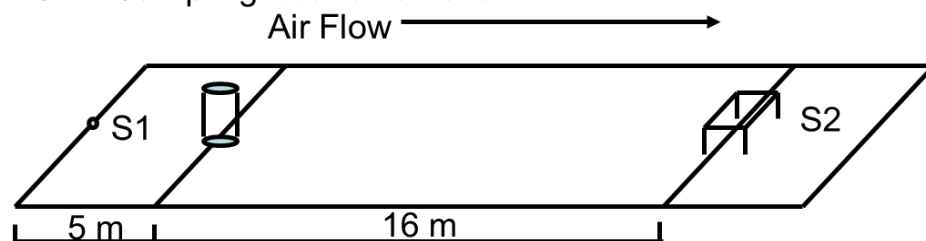

Figure 1 The rocket test stand with the position (1) of the burn pit and the (virtual) position of the sampling equipment (2)

¹ (TNO report: Verkennende beproevingen met netwerken van chemische "sensor arrays, A260, 2010).

The position of the sampling equipment is shown in Figure 2. Two tests were performed. The first test was carried out at a sampling height of about 1.8 m (breathing zone).

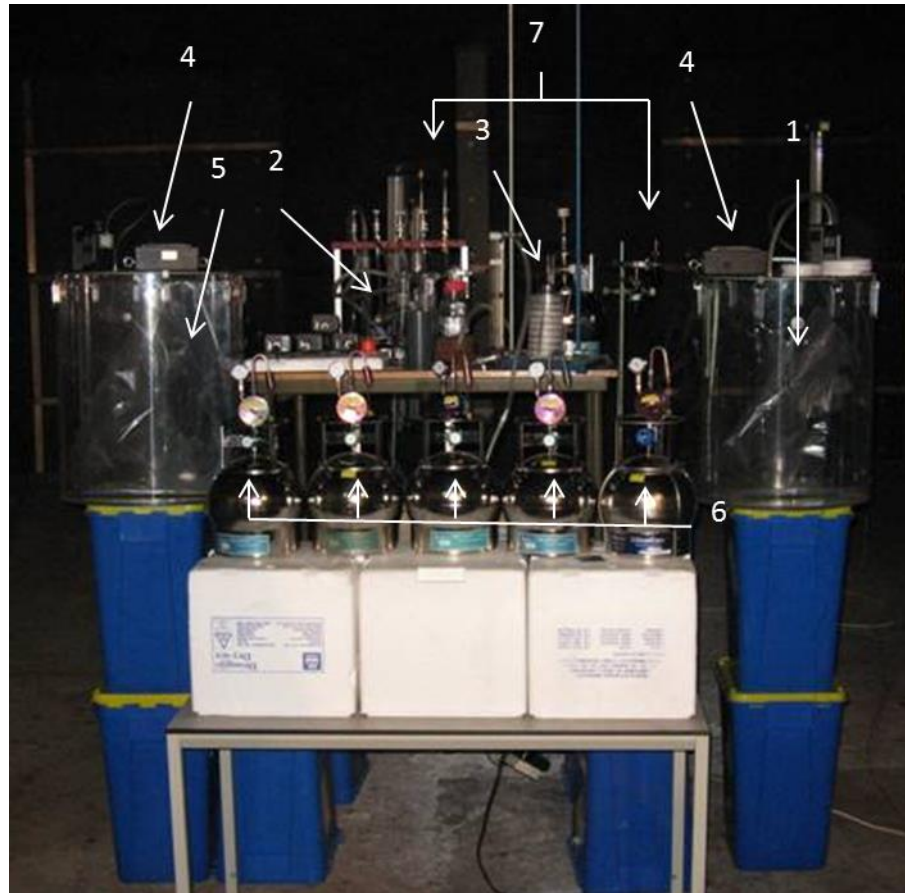

Figure 2 Positions of the sampling devices.

1. Gas sampling bag for the CULTEX[®] and the bubblers for the Microtox system
2. Several bubblers for SO₂, HCl, HBr, HF, phenol and aldehydes
3. 8 stage cascade impactor
4. Two chemical sensors (E-nose), one smoke sensor and one CO sensor
5. Gas sampling bag for FTIR and NO_x analyzing
6. Vacuum canisters
7. Tenax sampling tubes and HDS samplers.

The second test was performed with the sampling height at about 3 m, which was about 25 cm below the ceiling. The sampling points were positioned in the middle of the smoke plume.

2.2 First burn pit experiment, 30 March 2011

2.2.1 Test conditions

In Figure 3 the test set-up in the bunker is shown. The temperature within the fire was measured with a thermocouple in the middle of the barrel, a few inches below the rim. The air velocity in the test bunker was: 1-1.5 m/s, which results in a

refreshment of 20m³/s of air. The temperature was 12 °C with a relative humidity of 67-68%.



Figure 3 Initial test set up with sampling height at 1.8 m.

2.2.2 Composition of used waste materials

Table 1 shows a list of the contents of the garbage bags that were burnt.

Table 1 Contents of the garbage bags used during burn pit experiment 1

garbage bag No	Contents of the garbage bags
1	1 kg of plastic: disposable, unused cups, plates, cutlery
2	1 kg of mixed waste: empty paint cans, materials used for painting, 500 ml motor oil, 500 ml dry PUR foam 11m PVC tubes
3	1 kg of PET bottles, 3 kg of food (lasagne) in plastic packaging
4	2 kg of carpet foam and carpet insulation from cars.
5	5.8 kg of newspapers, magazines and cardboard boxes
6	6,4 kg pieces of tire rubber

2.2.3 Combustion process

The fire was started with two bags of fireplace wood, which were lit with half a liter of diesel. In Table 2 the observations made during the experiments are summarized.

The E-nose, smoke alarms and CO sensor were continuously operating during the entire experiment; the other equipment was turned on just before the first garbage bag was placed on the fire.

The pumps for the sampling equipment were started and cell cultivation trays were placed at the sampling points at the moment the fireplace wood was steadily burning. Subsequently, the first garbage bag was put into the barrel. The next garbage bag was put on the fire when the previous bag was completely burnt.

The total combustion and sampling time was 64 minutes. In total, 20.2 kg of waste (excluding the wood) was burnt. The samples were taken at a height of 1.8 m above the floor and a distance of 16 m from the fire drum.

Table 2 Observations during burn-pit experiment 1

Time	observations	remarks
10:35	2 bags of wood each 2.8 kg	- ignition of wood - temperature at the rim: 480°C
10:43 - 10:45	Pumps were started and cell cultivation dishes were placed	
10:47	garbage bag no 1 : 1 kg plastic	- a thick black smoke develops - the smoke drops down and partly hits the sampling points. - T : 710 °C
10:54	garbage bag no 2 : 1 kg waste	- less smoke and more flames - T : 630 °C
11:02	garbage bag no 3 : 4 kg food waste with PET bottles	- no intense smoke or flames - T 410 °C
11:06	garbage bag no 4 : 2 kg foam and insulation from cars	- very thick black smoke develops - CO-detector goes off - T : 500 - 650 °C
11:13	5,8 kg paper en 3x cardboard boxes	- many flames and less smoke - T: 750 °C
11:21	6,4 kg rubber tyres	- extremely thick black smoke with flames - T : 650 - 750°C
11:33	the combustion was stopped by closing the drum with a steel plate	- cell cultivation trays are being removed - temperature decreases to T 400°C
11:47	end of combustion by extinguishing with water	- stopping the sampling pumps - collecting the samples
All samples were collected for further analysis		

2.3 Second burn pit experiment, 11 May 2011

The second burn pit experiment was slightly different from the first experiment, because it appeared that for GC-MS analysis, the concentrations of the various compounds were around the detection level and there was no response of the CULTEX[®] and TOXcontrol systems in the first experiment. Only the E-nose, the CO-sensor and the cascade impactor had shown a distinct response. Therefore, the sampling equipment was placed in the middle of the smoke plume, which was about 25 -100 cm below the ceiling (at 3 m); see Figure 4.



Figure 4 The test set-up 25-100 cm below the ceiling, during the second burn pit experiment

2.3.1 *Initial conditions of the bunker*

The air velocity in the test bunker was: 1.2-1.4 m/s, which results in a refreshment of 20 m³/s of air. The temperature was 15-18°C with a relative humidity of 65%. The temperature within the barrel was measured with a thermocouple in the middle of the vessel a few inches below the rim.

2.3.2 *Composition of waste*

A second important difference relative to the first burn pit experiment was the composition of the garbage bags that were used. Instead of burning different types of waste consecutively, we now prepared well-defined collections of various military relevant waste materials, In Table 3 the contents of the garbage bags are summarized.

Table 3 Contents of the garbage bags during the second burn pit experiment

garbage bag No 1 (7,4 kg)	garbage bag No 2 (7.9 kg)	garbage bag No 3 (4.5 kg)	garbage bag No 4 (4.2 kg)
<ul style="list-style-type: none"> - 1 kg 2x paint cans and 500 ml motor oil - 1 kg Newspapers and magazines - 2 kg rubber of tire - ¼ kg PET-bottles - 1 kg lasagna - ¼ kg PVC tubes - ¼ kg black car carpet foam - 1 kg plastic - 100 gram dry PUR foam - Small piece of carpet - 2 batteries 9V 	<ul style="list-style-type: none"> - 1 kg 2x paint cans with paint materials - 500 ml motor oil - 1 kg Newspapers and magazines - 2.2 kg rubber of tire - ¼ kg PET-bottles - 1 kg lasagna and ¼ kg bread - ¼ kg PVC tubes - ¼ kg black car carpet foam - 1 kg plastic - 200 gram dry PUR foam - Small peace of carpet - 2 batteries D cell 	<ul style="list-style-type: none"> - 1 kg 2x paint cans - 500 ml motor oil - 1 kg Newspapers and magazines - ¼ kg PET-bottles - 1 kg lasagna and ¼ kg bread - 170 g PVC tubes - 200 g black car carpet foam - 100 gram dry PUR foam - Small piece of carpet - 4 batteries AA cell 	<ul style="list-style-type: none"> - 1 kg 2x paint cans - 500 ml motor oil - 1 kg Newspapers and magazines - ¼ kg PET-bottles - 150 g PVC tubes - 200 g black car carpet foam - 1 kg plastic - 70 gram dry PUR foam - Small piece of carpet - 4 batteries AA cell

2.3.3 Burn pit experiment

The experiment was performed in an analogous way as performed for the first burn-pit experiment. See Table 4 for observations.

Table 4 Observations during burn pit experiment 2

Time	observations	remarks
16:48	Starting ventilation of bunker	
16:56	2 bags of wood each of 5,6 kg ignited with 0,5 l diesel	
17:02		temperature at the rim of the vessel was 600-660°C
17:11-17:13	Starting sampling equipment	
17:16	garbage bag no 1 was placed on the fire	A thick smoke was formed
17:19	Acoustic alarm smoke sensor goes off	Alarm was manually stopped
17:25	Temperature at the rim was 530-550°C	
17:31	Temperature at the rim was 200-230°C	
17:31	TOXcontrol sampling was stopped	Because of the thick smoke the sampling of the bubblers were stopped, sampling time was sufficient.
17:32	Garbage bag no 2 was placed on the fire	Thick smoke was formed
17:32	Temperature at the rim was 580-600°C	

17:32	Acoustic alarm CO alarm and smoke sensor	Alarm was stopped manually
17:42	Temperature at the rim was 390-400°C	
17:46	Garbage bag no 3 was placed on the fire,	Less smoke was formed because no rubber tires were present
17:55	Temperature at the rim was 500-550°C No acoustic alarm (smoke detectors)	
18:01	Garbage bag no 4 was placed on the fire,	Less smoke was formed because no rubber tires were present
18:05	Temperature at the rim was 620-600°C No acoustic alarm (smoke detectors)	
18:09	Stopping the sampling equipment	
18:16	Fire went out	Temperature at the rim was 330°C
18:16	End of combustion by closing the drum and extinguished with water	
18:19	Stopping pump from cascade and the bubblers	
All samples were collected for further analysis		

2.4 Description of the various monitoring methods

2.4.1 Sampling of various smoke constituents

The sampling and analysis methods to determine the main gas components are based on STANAG 4602 ².

2.4.1.1 FTIR gas analysis of CO₂, CO, HCN, NH₃

A gas sampling bag (Tedlar 50 liters) was sampled with an air flow of 1 l/min for approximately 30 minutes. The gases were analysed with a Fourier Transform Infrared gas monitor (FTIR, Gasmeter DX4000). The gases were led through a dust filter and a Teflon tube (inner diameter 6 mm) through the 1.0 liter gas cell of the FTIR monitor. Every 20 seconds an IR spectrum was collected from the gaseous compounds in the measuring cell. The IR measuring range was from 4200 to 800cm⁻¹. The concentrations of the compounds were calculated using a reference spectrum of the compounds with a known concentration in ppm or vol%. The mean concentration was calculated over the 10 minutes sampling period.

2.4.1.2 NO and NO_x chemiluminescence monitor

From the sampled gas bag (see above) air was analysed during a 10-min period using a chemiluminescence NO_x-monitor (Thermo Model 42C High Level). The NO_x components were measured every 10 seconds. Chemiluminescence is based on a

² NATO STANAG 4602 - AFAP-3, NATO reaction to fire tests for materials, Toxicity of fire effluents, 2009

gas phase reaction of NO and ozone (O₃) to NO₂ which emits a characteristic luminescence signal. The intensity of the IR emission is directly proportional to the NO concentration. NO₂ was measured by conversion of NO₂ to NO on a stainless steel converter at 625 °C followed by measuring released NO. The monitor was calibrated using NO calibration gas of 16.4 ppm and 4000 ppm. The mean concentration was calculated over the 10-min sampling period.

2.4.1.3 *Ion chromatography-analysis of HCl, HBr, HF, SO₂*

In two in-line bubblers, each with 150 ml and 75 ml of sodium hydroxide solution, inorganic acids were captured. Air was pumped with an airflow of 2 l/min through the bubblers. Sampling was performed during the entire burn pit experiment. The front and rear bubblers were analysed separately. After adding 3% hydrogen peroxide solution to stabilize the compounds in the solution, the samples were stored at 4°C before analysing with Ion Chromatography (Dionex DX500 modular HPLC with Dionex ED40 detector)

2.4.1.4 *HPLC analysis of phenol*

In two in-line bubblers, each with 150 ml and 75 ml of a mixture of 40/60 water/methanol (v/v), phenol was trapped. Air was pumped with an airflow of 2 l/min through the bubblers. Sampling was performed during the entire burn pit experiment. The front and rear bubblers were separately analysed. The samples were stored cool at 4°C and the solution was analysed with HPLC.

2.4.1.5 *HPLC-analysis of aldehydes*

Aldehydes formed during the combustion process were captured in two in-line bubblers filled with 150 ml (first bubbler) and 75 ml (second bubbler) 2M HCl solution saturated with dinitrophenylhydrazine (DNPH). Air was pumped with an airflow of 2 l/min through the bubblers. Sampling was performed during the entire burn pit experiment. The front and rear bubblers were separately analysed. After extraction of the sample solution with chloroform the extracts were stored at 4°C and the components were analysed with HPLC (Waters, Acquity Ultra Performance LC with UV detector).

2.4.2 *GCxGC-MS analysis of hydrocarbons*

2.4.2.1 *HDS conditioning/sampling*

Helium Diffusion Samplers (HDS, Entech,USA) of two different types (15- and 60-120 minutes sampling time) were used. Each sampler was conditioned using a standard procedure. With a dedicated sampler conditioning system (Figure 5), developed by TNO, 4 samplers can be conditioned at the same time. Each sampler was repetitively subjected to pressure and vacuum, in order to rinse the 40 mL glass container. For the final conditioning each sampler was evacuated for 3 min and subsequently pressurized for 3 min with helium, containing an internal standard (10 ppm bromofluorobenzene) to 7 psi. After conditioning each sampler was checked with a pressure gauge to ensure the quality of the sampler.

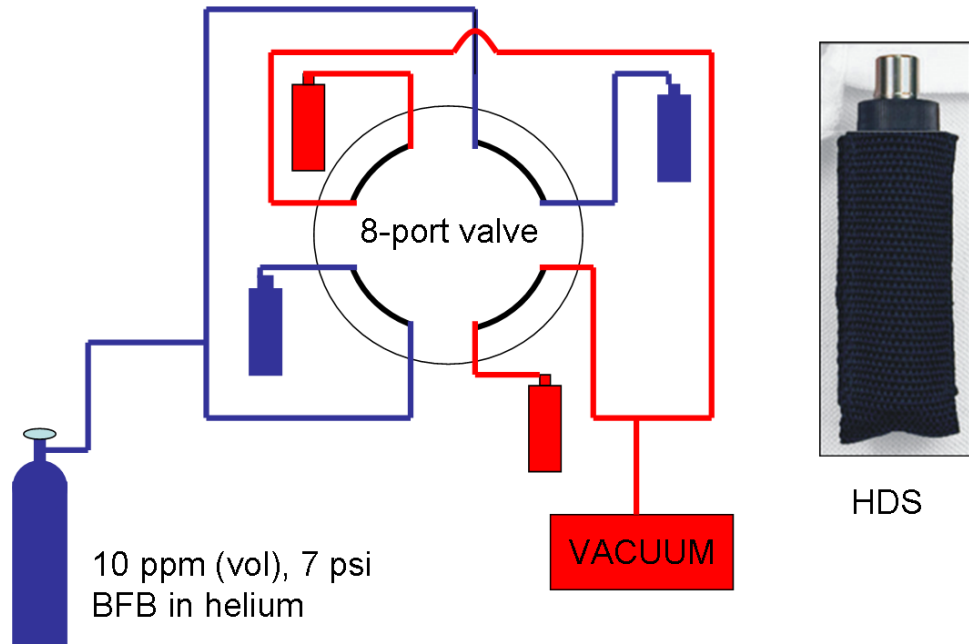

Figure 5 Schematic overview of the TNO HDS conditioning system

Just before using the samplers for the actual experiments, a pressure gauge was used to check for leaking of the samplers. A pressure of 7 psi indicated that the samplers were leak tight. The samplers were installed at the two locations in the bunker. At T=0, just before dropping the first bag of waste, each sampler was opened to initiate the helium diffusion process. All samplers were kept open during 1 h (including the 15-min samplers).

Table 5 Description of samples taken during burn pit experiment nr 2

Sampler code	Sample description
15 min S1	Blank, rocket stand started at T=0
15 min S2	Smoke sample, started at T=0
15 min S3	Smoke sample taken at suit of fireman walking through the smoke, T=30
2 hr S1	Smoke sample, started at T=0
2 hr S2	Smoke sample, started at T=0
2 hr S3	Smoke sample, started at T=0
2 hr S4	Smoke sample, started at T=0

After the experiment, each sampler was closed and was taken to the laboratory for analysis with GCxGC-TOF mass spectrometry. The analytical method used has been described below.

2.4.2.2 Canister conditioning/sampling

An air sampling canister (HDS, Entech, USA) was conditioned by repeatedly evacuating and pressurizing. The canister was fitted with a valve that was closed when the canister was under vacuum. To prevent particles from entering the canister, a small fiber glass filter was installed. To control the speed of air sampling, a fixed restriction was installed. This resulted in a steady air sampling flow by release of vacuum (75-100 mL/min). The canister was positioned in the smoke and the valve was opened just before the start of the experiment. After the burn pit

experiment the valve was closed and the canister was taken to the lab for further analysis.

2.4.2.3 *Analytical method for HDS samplers/Canister (HDS GCxGC-TOFMS)*

HDS vials and the canister were connected to a HDS autosampler (Entech, USA). The autosampler pressurized each HDS vial prior to transferring the air through a heated transfer line (120 °C) to the sample loop (1 mL). A 6-port valve, installed on a 6890 GC (Agilent, USA), was used to transfer the air sample to the first dimension column. A Cryo cooler (ATAS GL, The Netherlands) was used to cool the first part of the GC-column (Factorfour VF-5ms, 29 m * 0.25 mm, df. 0.25 µm, Varian, The Netherlands) down to -100 °C to promote focusing of the target components on the stationary phase. The first dimension separation was performed by heating the main oven from 40 °C (10 min) to 150 °C (2 min) at a rate of 5 °C/min. To enable second dimension separation a modulator was installed on the second dimension column (CP WAX, 1,5 m * 0.1 mm, df. 0.1 µm, Varian, The Netherlands). The modulator was heated to 30 °C above the first dimension oven temperature and cryo-cooled nitrogen gas was used for modulation of the fractions coming from the first dimension column. The second dimension separation was performed by heating the additional oven from 50 °C (10 min) to 160 °C (2 min) at a rate of 5 °C/min. A Time Of Flight mass spectrometer was used for detection of the chromatographic peaks. The transfer line and source were set to 225 °C and the recorded mass range was 45-400 amu. Data acquisition and processing was performed with ChromaTOF software (LECO, USA).

2.4.2.4 *Tenax tube conditioning/sampling*

Conditioning of the Tenax tubes (Gerstel, Germany) was performed by rinsing the tubes with 5 mL solvent (MilliQ water, methanol, n-hexane and ethyl acetate) on a vacuum block to elute most of the chemical pollutions present on the tubes. The tubes were placed in an oven at 250 °C (overnight) under a stream (10 mL/min) of helium to bake out. A TDS-GCMS was used to check the tubes for blank signals using the same method as will be used for analyzing the samples and will be described in another part of this chapter. Prior to sampling, each tube was capped with brass ¼ inch Swagelok end caps. In total three tubes were sampled during the burn pit experiment 2 using a series of vacuum pumps. A blank sample (30 L) was taken at the rocket stand (30 L, two other tubes were sampled with different air flows (100 and 800 mL/min) in the smoke. A fourth tube was sampled afterwards in the lab from a Tedlar bag which had been filled during the experiment (6 L). After sampling for 1 h, each tube was closed and taken to the laboratory for further analysis.

2.4.2.5 *Analytical method for Tenax tubes (TDS-GCMSD)*

Tenax tubes were desorbed using a Thermal DeSorption Autosampler (TDAS, Gerstel, Germany) attached to a CIS injector (Gerstel, Germany) installed in a 6890 GC (Agilent, USA). A Factorfour VF-5ms (Varian, Netherlands) GC column was used for separation. The column was attached to a 5973 N Mass Selective Detector (Agilent, USA) for identification and quantification of the eluted components. Tenax tubes were heated from 20 °C to 260 °C at a rate of 60 °C/min under a flow of 20 mL/min for 3 minutes. Components were transported to the cooled injector through the transfer line, heated at 300 °C, for focusing. Injection of the components was performed by heating the injector from -75 °C to 260 °C at a rate of 12 °C/sec and holding the final temperature for 10 min. The oven temperature program was

started at 40 °C (1 min) and was programmed at a rate of 10 °C/min to 280 °C (5 min). The transfer line of the MSD detector was kept at 275 °C to prevent condensation of components just before entering the detector. The Electron Impact source temperature was 250 °C and the scan mass range was set to m/z 25-550. Data was recorded and processed using MSD Chemstation (Version D.02.00.275, Agilent, USA).

2.4.2.6 Particle size determination of the smoke dust

The particle size determination of the smoke particles was performed using an 8-stage cascade impactor (Anderson, 1ACFM non-viable ambient particle sizing sampler).

The particles were captured on different plates for different size classes. The amount of material captured on each of the plates was determined by weighing. Through a calculation based on the particle size, density and mass of captured particles the number of particles for each size class was determined. The solid material concentration was calculated from the ratio of the total mass of material captured by the cascade impactor and the volume of air sucked through the sampler.

2.4.2.7 Sample preparation/analysis of the cascade impactor filters

The cascade impactor filters were received in the lab for residue analysis. On each filter disk a layer of soot particles could be observed. Each disk was separately extracted by washing the disks with 6 mL of dichloromethane. The particles were vortexed to promote extraction of organic components from the soot particles. After centrifuging the samples at 3,750 rpm for 5 minutes, the liquid was placed in a GC vial for analysis with GC-MSD. 1 μ L of sample was injected in a split/splitless injector (Agilent, USA) in splitless mode at 275 °C. A Factorfour VF-5ms (Varian, The Netherlands) GC column was used for separation. The column was attached to a 5973 N Mass Selective Detector (Agilent, USA) for identification and quantification of the eluted components. The GC oven (Agilent, USA) temperature program started at 40 °C (1 min) and was programmed at a rate of 10 °C/min to 280 °C (5 min). The transfer line of the MS-detector was kept at 275 °C to prevent condensation of components just before entering the detector. The Electron Impact source temperature was 250 °C and the scan mass range was set to m/z 25-550. Data was recorded and processed using MSD Chemstation (Agilent, USA).

2.4.2.8 *In vitro* toxicity measurements with CULTEX[®] and TOXcontrol systems

The *in vitro* toxicity measurements during the burn pit experiments were carried out with human lung cells in culture (A549/CULTEX[®] system) and luminescent bacteria (*Vibrio fischeri*/TOXcontrol).

The measurements with the TOXcontrol and the CULTEX[®] system were both carried out with flue gas that had been collected during the burn pit experiments by using a gas sampling bag. During the second burn pit experiment (11-05-11) the TOXcontrol measurements were also carried out on-line, by leading the flue gas from the burn pit directly through the bacterium suspension.

2.4.2.8.1 TOXcontrol assay

The freeze-dried bacteria and cultivation media (box of 10 vials, article no. 02TCB00304) were purchased from MicroLAN b.v (Waalwijk, The Netherlands). The bacteria were reconstituted in 50 ml media and cultivated in a 100-ml flask on a TOXbioshaker (article no. 03TCB00201 microLAN). The bacteria were cultivated for

20 hours at 20 °C and then kept at 4 °C. During this cultivation the orbital mixer was set on 200 rpm. After a minimum of 2 days at 4 °C the bacteria can be used for toxicity experiments, Cultures kept at 4 °C for more than 7 days should not be used. For the toxicity experiments 320 µl of the cultivated bacterial suspension was added to 40 ml 2 % NaCl and transferred to a 100 ml washing bottle. The flue gases from the gas sampling bag (collected during the experiment) were lead at a flow-rate of 100 ml/min through a washing bottle with bacterial suspension for different periods of time, with a maximum of 40 minutes (March 30th 2011). Based on this experiment a sampling time of 30 minutes was chosen for further experiments.

During the second experiment we exposed both on-line and from the gas sampling bag. During the online exposure air was lead through the bacteria for 30 min, in an analogous way as employed for the gas sampling bag procedure. We used a parallel non-exposed washing bottle, containing the bacteria suspension, as a control. With the exposure from a gas sampling bag (offline) we used medical air as a control. In addition, the toxicity of a 'clean' environment was measured as a control in a separate experiment. Directly after the exposure the luminescence of the bacteria suspension was measured in a 96-well plate (100 µl per well) with a liquid scintillation and luminescence counter (Wallac 1450 MicroBeta Trilux, protocol 10).

2.4.2.8.2 *CULTEX*[®]

Human epithelial lung cells (A549) were exposed to flue gases (from a gas sample bag) for 60 min at a flow rate of 8 ml/min/well. In addition, open cups with lung cells were placed in front of (A) and after (B) the fire. Biomarkers for the toxicity were LDH release (membrane damage), reduced GSH concentration (oxidative stress), Alamar blue conversion (mitochondrial activity) and protein content (RC-DC / apoptosis). For a detailed description of the *CULTEX*[®] system and associated biomarker assays, see Wijte et al. (2011). The reference measurements were carried out in a clean environment.

2.4.3 *On-line sensors*

Two wireless chemical sensors (Comon-Invent, E-Nose) were placed on the top of the gas sampling vessels. In addition, a commercially available dust sensor and a carbon monoxide sensor (both having only an acoustic alarm) were positioned on the top of the gas sampling vessel.

The E-Nose sensors were used during the entire burn pit experiment to measure the gaseous components released from the fire.

The E-Nose is composed of an array of eight different metal oxide semiconductors, with different sensitivity (around 10-50 ppb) and selectivity for the various compounds. By deriving signals from the 8 different microsensors a 'fingerprint' pattern will be obtained for a specific gas or gas mixture. The idea is that the composition of the detected gas can be derived from the measured pattern, which poses high demands on the software designed for this purpose.

The E-Nose is a box with dimensions of 16 x 11 x 6 cm. By diffusion through a grille on the cabinet, the gases are detected by the sensors. Every 5 seconds a measurement of the response of the sensors was sent by GPS to a central computer of Comon Invent, for data processing. The data could be viewed directly through wireless internet using an account of Comon-Invent. The measurements are depicted as a response of the eight sensors signals versus time.

3 Results

3.1 General

Based on the preliminary results obtained during exploratory experiments, the experimental set-up was slightly modified during the first burn-pit experiment. The sampling position was raised to 1.8 m. The HDS vials were positioned on a lab stand at various heights ranging from 2 meters stretching to the ceiling to test the influence of the height on the sampled air. A metal barrel (1.5 meter high) was used as a fire pit enclosure to maintain a compact burn pit. The fire was started by lighting two 20 liter bags, filled with wood, with some diesel fuel. When the fire was burning properly, bags with waste were added to the fire. The total experiment took 1 hour. The sampling of air started just before the moment that the first 'waste' material was added to the fire. During the experiments an air flow of approximately 1-1.5 m/s was passed through the tunnel, leading the smoke to the sampling devices.

For the second experiment it was decided that the sampling should be performed at maximum height, because it appeared that most of the smoke flowed just below the ceiling of the bunker. A large number of sampling devices were installed, including a series of samplers from the RIVM (National Institute for Public Health and the Environment). The fire was started in a similar way as during the first burn pit burn experiment but the 'waste' material was added to the fire after the biggest flames had vanished. The idea was that adding the waste at the moment the fire stopped burning, the smoke was formed by a smouldering fire instead of a high temperature burn pit. This should generate more and thicker smoke. To make the experiment more realistic, waste was mixed in plastic bags before throwing them on the fire. The mixture was kept the same for each bag to produce a reproducible smoke profile.

3.2 Analysis of low molecular smoke gas components

The results of the analysis of specific target components in flue gas, sampled in the gas sampling bag, bubblers, and particulate matter are shown in Table 6. The concentrations are the mean results of a 1 hour sampling period. The compounds measured during the first experiment, in the smoke plume at a level of 1.8 m in the test facility, gave values which are around or below the detection limit. As was to be expected, the concentrations measured directly in the smoke plume in the second burn pit experiment were substantially higher compared to the first experiment. The compounds which could be detected were CO, NO_x, SO₂, HCl, formaldehyde, acetaldehyde and particulate matter. The measured concentrations were compared with Short Term Exposure Limit (STEL) values and/or Ceiling values, and/or Military Exposure Guideline (MEG) values.

STEL values are defined by the ACGIH (American Conference of Governmental Industrial Hygienists) as the concentration to which workers can be exposed continuously for a short period of time without suffering from: (i) irritation, (ii) chronic or irreversible tissue damage, and (iii) narcosis of sufficient degree to increase the likelihood of accidental injury, impair self-rescue or materially reduce work efficiency.

STEL's are generally used only when toxic effects have been reported from high acute (short-term) exposures in either humans or animals. Workers can be exposed to a maximum of four STEL periods per 8-hour shift, with at least 60 minutes between exposure periods

'Ceiling' values are exposure limits that should never be exceeded, as defined by the U.S. Occupational Safety and Health Administration (OSHA).

MEG values are defined by the US Army Public Health Command for deployed military personnel. A MEG is a chemical concentration which represents a safe-sided estimate of the level above which certain types of health effects may begin to occur in individuals after an exposure of the specified duration (short term: 1 hour, 8 hours, 14 days; long term: 1 year). The severity of the health effects and percentage of the exposed population that might demonstrate the health effects may increase as concentrations increase above the MEG. However, the degree to which severity and/or incidence of health effects increase as exposure increases above the MEG is chemical-specific. For the purpose of the current burn pit study 1-h MEGs are most relevant.

Threshold Limits Values (TLVs) are not suitable for comparison, because these are intended for occupational exposures of 8 h per day, 5 days a week, a working life long, which is not a realistic exposure scenario for burn pits.

It is clear from Table 6 that only for nitrogen dioxide and hydrogen chloride the MEG values for negligible effects are exceeded by the concentrations measured in the second burn pit experiment, but not the respective STEL and Ceiling values for these compounds. The MEG for a marginal effect of hydrogen chloride and nitrogen dioxide for a 1-h exposure are 33 and 27 mg.m⁻³, respectively, which are well above the concentrations measured in our burn pit experiments. So, when looking at the individual components, there does not seem to be much reason for concern when assuming short term exposure to the burn pit emissions. However, it has to be realized that personnel is not exposed to individual chemicals when in the vicinity of a burn pit, but to mixtures of compounds. The toxicity of such mixtures is difficult to predict. Therefore, the acceptable exposure limit for exposure to mixtures is likely to be lower than that of individual chemicals.

Table 6 Typical low-molecular smoke constituents analyzed during the burn-pit experiments

Components	First burn-pit experiment Mean concentration mg/m ³	Second burn pit experiment Mean concentration mg/m ³	Background Mean concentration mg/m ³	Reported exposure limit mg/m ³
Water H ₂ O	4,110	5,750	5,600	-
Carbon dioxide CO ₂	940	2190	950	STEL 54,000 MEG 50,000
Carbon monoxide CO	< 6	53	< 6	Ceiling 229 MEG 95
Nitric oxide NO	0.1	1.7	<0.1	MEG 3.7
Nitrogen dioxide NO ₂	1.6	4.5	< 0.15	STEL 9.4 MEG 0.94
Sulphur dioxide SO ₂	< 0.1	0.74	< 0.1	STEL 13 MEG 8
Hydrogen fluoride HF	< 0.1	< 0.1	< 0.1	Ceiling 5 MEG 0.82

Hydrogen bromide HBr	< 0.1	< 0.1	< 0.1	Ceiling 10 MEG 3.3
Hydrogen chloride HCl	< 0.1	5.5	< 0.1	Ceiling 7 MEG 2.7
Ammonia NH ₃	< 1	< 1	< 1	STEL 27 MEG 17
Hydrogen cyanide HCN	< 1	< 1	< 1	STEL 5 (skin) MEG 2.2
Phenol C ₆ H ₅ OH	< 0.01	<0.01	< 0.01	Ceiling 60 MEG 58
Formaldehyde HCHO	0.04	0.28	<0.03	STEL 2.5 MEG 1.2
Acetaldehyde CH ₂ CHO	0.03	0.12	<0.03	MEG 8137
smoke dust	2.2	26.3	<0.05	-

MEG values for negligible effects after 1-hour exposure

3.3 Results of the Cascade Impactor

The formation of fine particles was measured with the cascade impactor for monitoring the distribution of particle size in the smoke. Knowledge of the aerodynamic dimension of particles is vital to understanding their potential health effects and to determine the best methods of control. The purpose is to obtain an impression of the fraction of the smoke that can be inhaled.

In Figure 6 a histogram is shown, depicting the distribution of the percentage mass of aerodynamic particle diameter distribution of the smoke sampled during the two burn pit experiments. In both tests they show the same mass particle distribution. The small difference can be the effect of sampling directly in the smoke cloud or at the edge of the cloud which was during the first burn pit experiment.

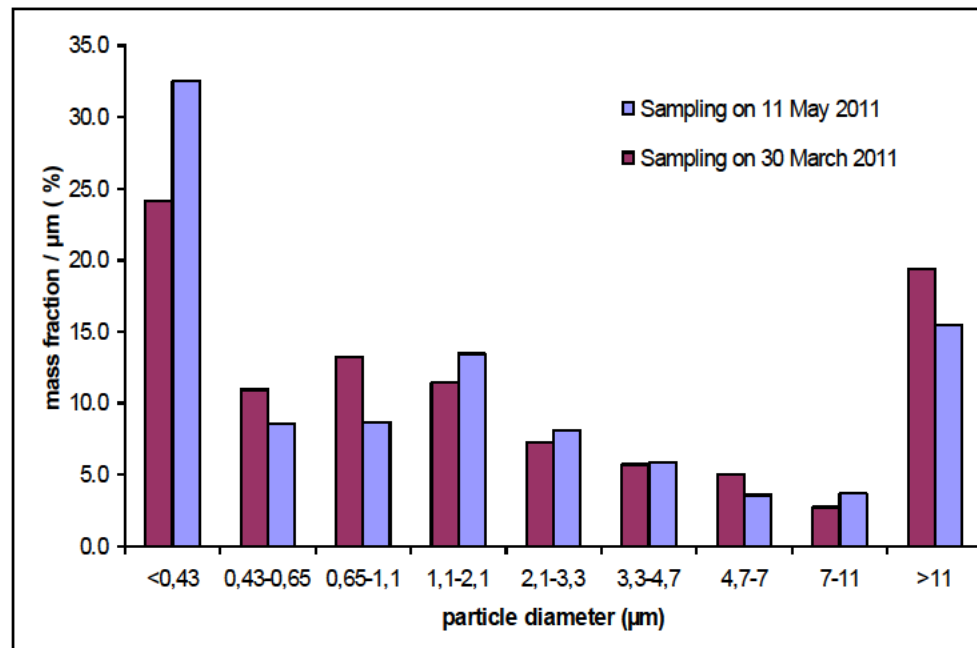

Figure 6 Percentage aerodynamic particle diameter distribution of the smoke sampled during the first (30 March 2011) and second (11 May 2011) burn pit experiment

3.4 Volatile organic components (VOC)

The following data were obtained during the second burn pit experiment.

3.4.1 Tenax tubes/Tedlar Bag

Chromatograms obtained upon analysis of Tenax tubes were processed with data analysis software and evaluated prior to integration. The Tenax tube, loaded with 48 liters of air, gave an extremely overloaded chromatogram (see Figure 7). In addition, poor focusing of volatile components such as benzene and toluene (retention time. 0-6 minutes) distorted the chromatogram due to peak broadening.

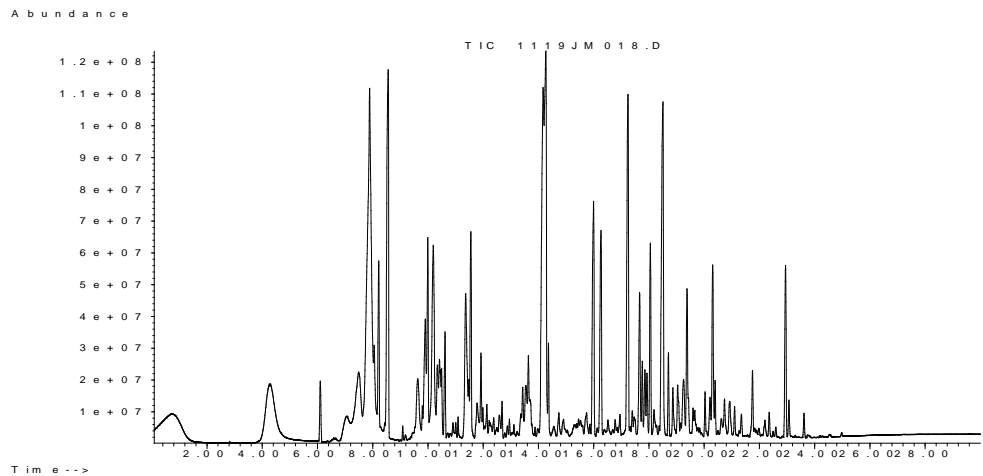

Figure 7 GC-MS chromatogram of Tenax air sample (48L) with highly overloaded peaks

It was therefore decided that this data file was not used for integration and quantification. The 6 L Tenax air sample gave more useful results; see Figure 8. Peaks were integrated and each significant peak was identified based on a NIST library search. The area of each separate peak was used for quantification, performed with Microsoft Excel. A set of reference standards was used to calculate a calibration curve. Peaks, not present in the reference standard, were quantified relative to the nearest reference standard peak (see Table 7).

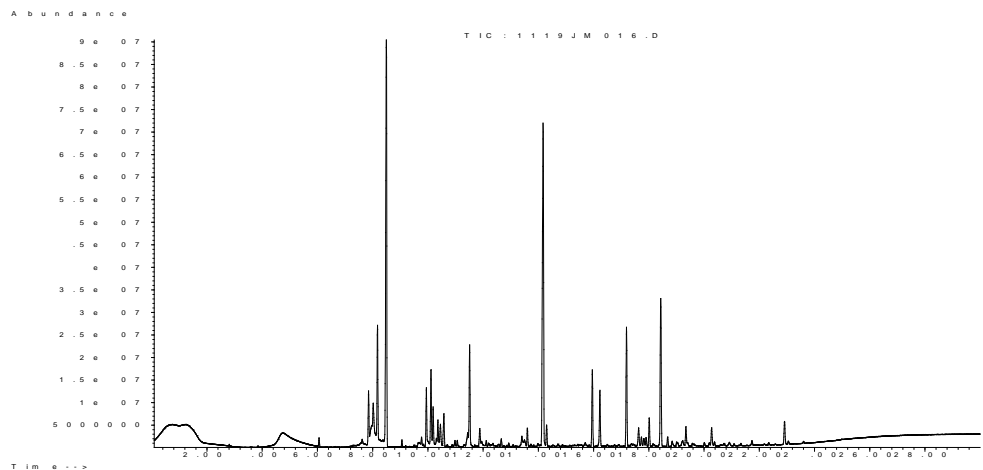

Figure 8 GC-MS chromatogram of Tenax air sample (6L) with peak broadening for volatile components

Table 7 Overview of chemical components present on Tenax tubes, sampled directly on Tenax or through a Tedlar bag

See Appendix 1

The blank sample contained some background levels (mostly below 1%) of organic components also found in the smoke samples. The 'Tenax 6L T=0' sample shows peaks with estimated concentrations ranging from 5-18,500 $\mu\text{g}/\text{m}^3$. Especially benzene and toluene are present in high concentrations. The concentration of styrene is also significantly higher. During the burn pit experiment a lot of plastics were burned, which explains the presence of these chemicals in such high concentrations. The measured concentrations therefore represent an average concentration for the whole experiment. The total yield of aromatic compounds was approximately 25.5 mg/m^3 . The 6L sample taken in the middle of the smoke plume, showed a significant number of high boiling poly-aromatic hydrocarbons (retention time 17-23 min). The individual concentration of each component is relatively low, but when combined, PAHs gave an estimated total summed average concentration of 1 mg/m^3 . A number of these components are listed as carcinogenic substances when inhaled.

The Tedlar bag was sampled at a slightly (20 cm) lower spot in the smoke compared to the Tenax samples. In this case, the total yield of aromatics was approximately 18 mg/m^3 which is slightly lower than obtained after sampling within the smoke plume. In addition, higher boiling chemicals such as biphenyl and higher PAHs were observed at much lower levels. Probably most of these components stick to the walls of the plastic gas bag during storage and will eventually not be sampled on the Tenax tube. This, in combination with the slightly lower sampling point, can explain why most components were detected at a (much) lower level than found for the Tenax sample taken directly in the smoke plume.

3.4.2 Analysis of HDS and canisters

The HDS vials were analyzed by means of GCxGC-MS, following the analytical procedure described in the experimental part. The canister was connected to the autosampler by attaching a quick connector to the valve of the canister and opening the valve. In this way it was possible to analyze the contents of the canister using the previously described HDS analysis method. Since the samplers and canister were not positioned on exactly the same place in the bunker during the experiment, the obtained data was not used for reproducibility calculation. Each chromatogram was reviewed by setting the Y-axis to a logarithmic scale for small peak enhancement. An example of a 'total ion current' (TIC) chromatogram is presented in Figure 9. A series of big peaks are clearly visible between 0-1000 seconds. This part of the chromatogram is representative for the most volatile components such as benzene, toluene and smaller n-alkanes. The region from 1000 seconds to the end of the run does not display any peaks.

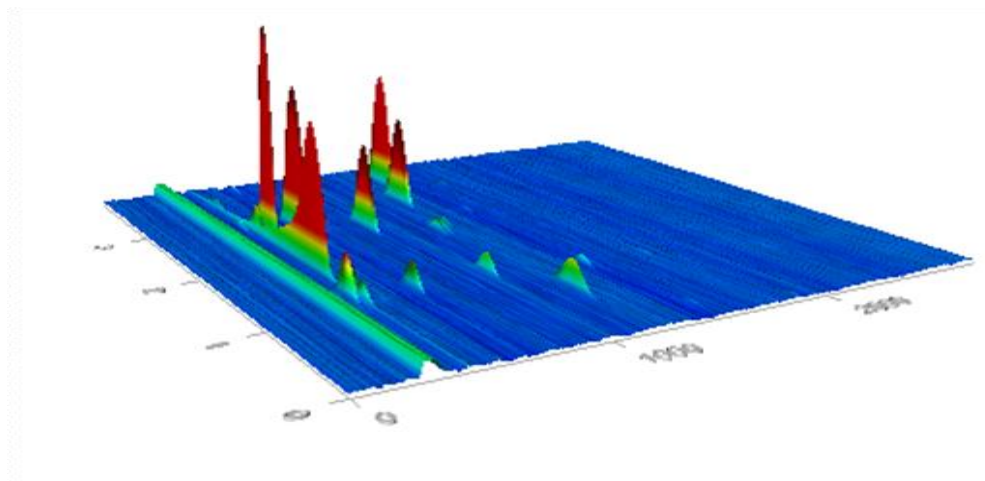

Figure 9 3D plot of the TIC chromatogram of the 15S2 HDS sampler placed in the smoke for 1 hour after GCXGC TOF MS analysis

When a selective mass is used to display a chromatogram, for instance m/z 105 (common in mono aromatic components), a completely different chromatogram is obtained (see Figure 10). In this chromatogram a series of peaks appears between retention time. 1000-1500 seconds. These peaks are significantly less intense than the peaks visible in the chromatogram shown in Figure 9 and would easily have been missed without using mass spectrometry. Each chromatogram showed a large number of peaks but often the peaks showed a poor TIC intensity. It was decided to process only the peaks with a TIC signal-to-noise ratio larger than 10:1 and a library hit% above 70%. Quantification is based on a single component slope (ethyl benzene).

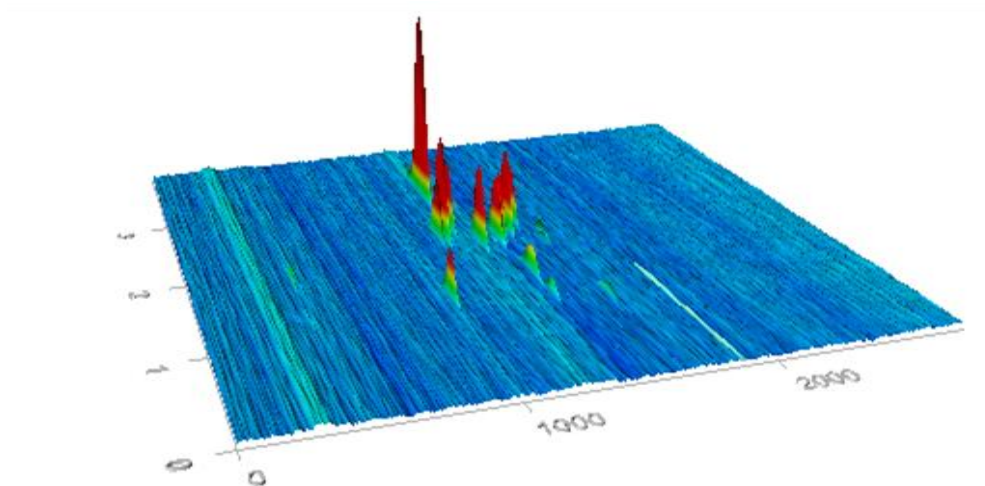

Figure 10 Chromatogram based on selected m/z 105 of the 15S2 HDS sampler

A 15-minute HDS vial, positioned on a fireman who walked through the smoke for 5 minutes at the end of the experiment, showed only a small number of peaks with sufficient intensity to be quantified (see Table 8). The found concentrations were all close to the detection limit (<100 ppb) except for dichloromethane and isopropanol (used for cleaning sampler). At the moment the fireman walked through the smoke, no plastic materials were introduced into the fire barrel anymore and the fire was

almost extinguished. This in combination with short exposure time of the sampler could be the explanation for the absence of VOCs in the sampler.

Table 8 Semi-quantitative results after analysis of the HDS sampler positioned on the fireman during the second burn pit experiment

Name	Conc. (ppb)
Acetonitrile, amino-	92
2-Propanol, 2-methyl-	1525
Methylene Chloride	13471
Benzene	13
Ethylbenzene	33
p-Xylene	51
BFB	3492

A 15-minute sampler, positioned directly in the smoke showed a much larger number of peaks (52, see Table 9) after filtering for s/n ratio and library match %. Peaks with a retention time below 500 seconds, gave a poor library match. This is the result of the selected mass range, used for acquisition (m/z 45-500). Components migrating in the beginning of the chromatogram often have a low molecular mass and therefore the fragments obtained with EI ionization consist of very small masses (below m/z 45). The result is a mass spectrum that misses critical information for good identification. For future experiments the acquisition mass range has to be lowered to m/z 25 to prevent loss of critical mass spectrum information.

Table 9 Semi-quantitative results after analysis of the 15-minute HDS vial, positioned directly in the smoke during the second burn pit experiment

See Appendix 2

Comparison of the data obtained from the 15-minutes sampler with the data from the 2-hour sampler (Table 10) shows some significant differences. Firstly, the number of analyzed components is larger for the 2-hour sampler. This is probably the result of adding different types of materials during a period of 1 hour. Also, it has to be kept in mind that the temperature in the barrel changes with every new addition of waste material. In general it can be stated that for short peak concentrations in air, sampling for a short period of time will result in a higher concentration of the compound of interest in the sampler; this phenomenon is exemplified with a lower benzene concentration in the 2-hour HDS compared with the 15 min sampler. This underlines the need for a trigger that starts the sampling procedure at peak levels of components in air, instead of sampling during longer periods. The combination of air monitoring with sensors, which are able to initiate sampling at sudden changes in air composition, would satisfy this need.

When the HDS analytical data are compared with the Tenax data, the absence of PAHs in case of HDS is obvious. This might be caused by the fact that the actual read-out of the HDS was performed at room temperature, which may result in a loss of high boiling components. For future use of HDS samplers in these kinds of projects, it is important to heat the samplers prior to analysis, in order to promote evaporation of higher boiling components. When the response for benzene is

compared between both techniques it becomes clear that there is not much difference in response: 32 mg/m^3 is found with HDS and 18 mg/m^3 is found with Tenax. The advantage of using the HDS, however, is the absence of a mechanical pump.

Table 10 Semi-quantitative results after analysis of the 2-h HDS, positioned directly in the smoke during the second burn pit experiment

See Appendix 3

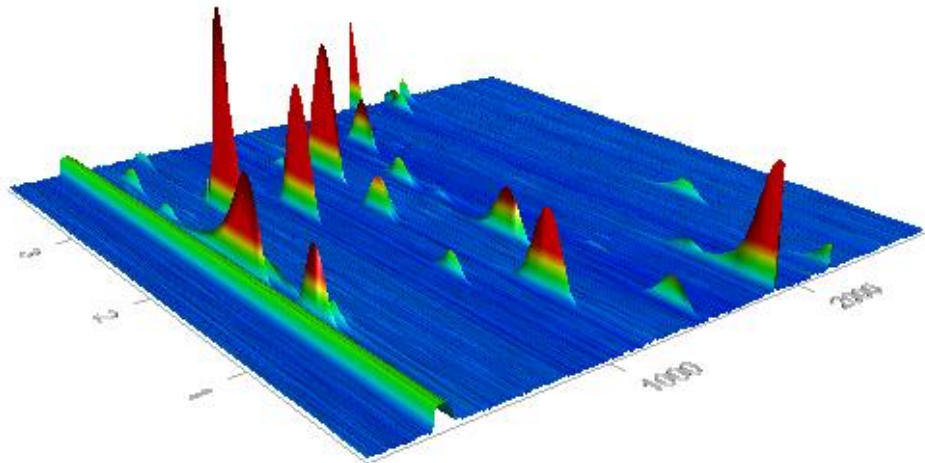

Figure 11 3D Chromatogram of the Canister used for air sampling based on vacuum

Analysis of the sample collected with the canister displayed more than 100 significant peaks (Figure 11; see also Table 11). When examining the raw data most of the compounds analyzed in the canister, could also be found with the HDS. In case of the HDS, however, the s/n ratio for these peaks was too low ($< 10:1$) to be presented in the peak table. The drawback of a canister is the risk of loosing reactive or sticky components to the metal walls of the container. HDS samplers have silico steel treated metal parts to prevent sticking of chemicals. Storage of a vacuum canister prior to use is difficult: when a small leak is present, the initial vacuum slowly disappears by introducing air into the canister which can contain contaminants. The advantage of HDS vials is that these are stored with helium under pressure (7 psi). When HDS vials suffer from small leaks during storage, only some helium gets lost. As long as there is a positive pressure on the samplers prior to use, a clean sampler is guaranteed. Cleaning samplers is also easy by replacing the sample vial and rinsing/backing out the metal parts. This reduces the risk for cross-contamination.

Table 11 Overview of components found and semi-quantified in the canister, sampled during the second burn pit experiment

See Appendix 4

3.4.3 GC-MS analysis of extracted cascade impactor filters

One of the risks is that the soot transports quantities of small organic molecules deep into the lungs. The soot particles can get trapped in the lungs, slowly releasing the adsorbed chemicals. The filters of the cascade impactor were extracted with dichloromethane (DCM). The aim was to extract chemicals attached to the soot collected on the series of filters into the liquid phase prior to analysis. The GC-MS results show that hardly any peaks are visible (see Figure 12). Especially the first parts of the chromatograms were completely blank in the TIC-mode. In the high boiling point range some low-intensity peaks were detected which could be attributed to inter alia PAHs.

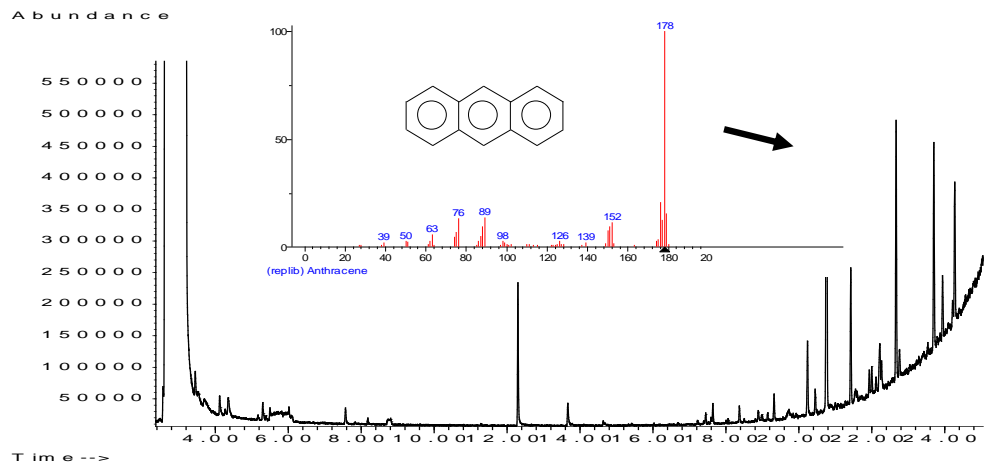

Figure 12 Chromatogram of DCM extract of a cascade impactor filter sampled during the second burn pit experiment

3.5 Results of the on-line sensors

During the burn pit experiments a number of sensors had been installed which were continuously measuring the atmosphere. The responses of the two E-nose sensors (Comon-Invent) were followed on-line, using an ordinary laptop. Every 5 seconds a measurement was performed with eight semi conductivity metal oxide sensors. On the screen of the laptop the smoke clouds could be followed at the moment waste material was put onto the fire. Both E-nose sensors gave the same response during the experiment. The measurement begins at the moment the combustion starts with the wood fire and ends when the fire has been extinguished.

In Figure 13 the course of the response of the eight sensors of the E-nose is shown. The movements in the curves clearly show when material was burned. The sensors did not always respond in the same way. The combustion of wood or paper shows a reaction of only a few sensors compared with the response by the other materials in the waste.

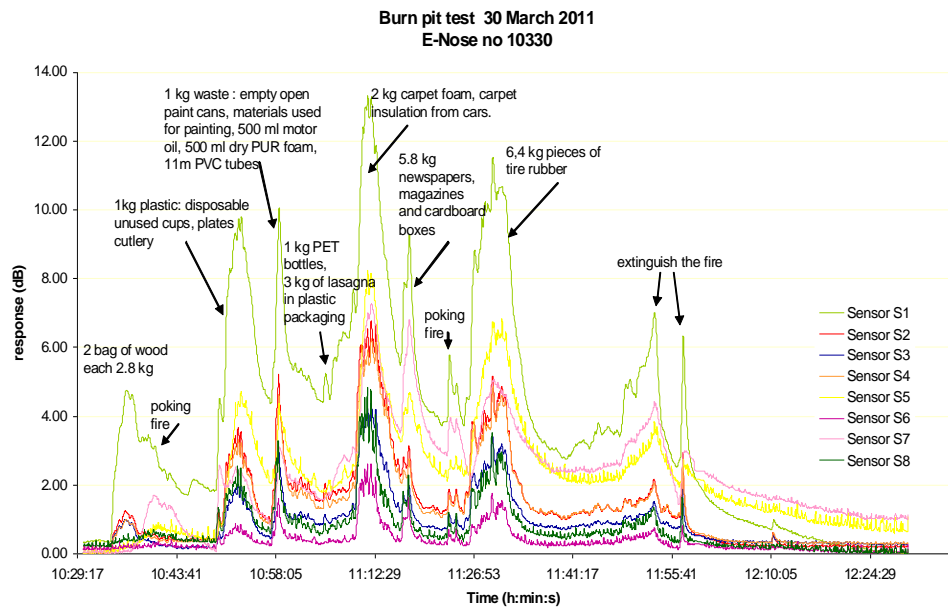

Figure 13 Response of the E-nose sensors during the combustion of selected materials during the first burn pit experiments

In Figure 14 the responses of the sensors are shown during the combustion of a mix of waste during the second burn pit experiment, while measuring directly in the smoke cloud. The response clearly shows the different time points that the bags with waste material were put onto the fire.

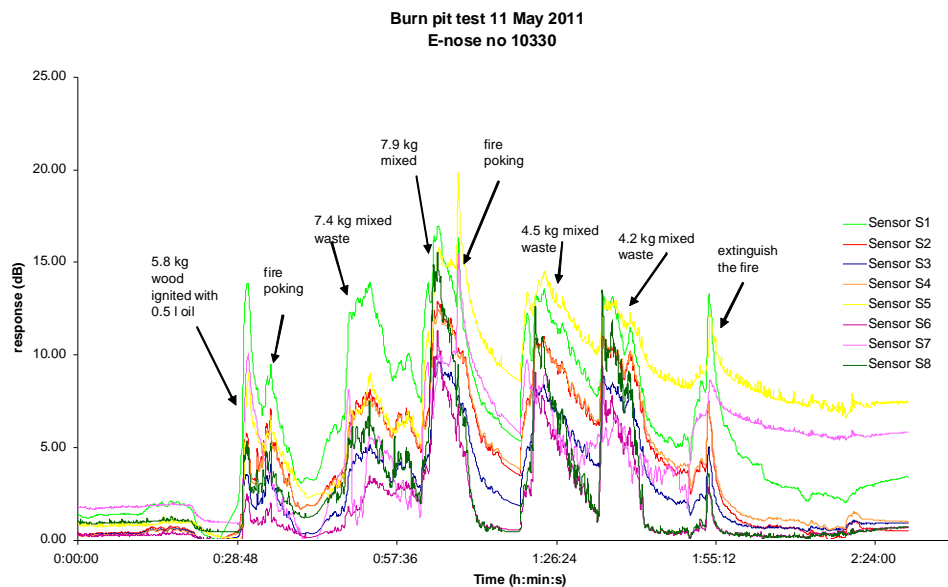

Figure 14 Response of the E-nose sensors during the combustion of selected materials during the second burn pit experiment

During the first test there was no alarm of the commercial smoke detectors and CO sensors when installed on the edge of the cloud. During the second test, they gave only a response during the combustion of the waste bags 1 and 2, after they were put on the fire.

3.6 Result of the CULTEX[®] and TOXcontrol systems

3.6.1 Measurements during the first burn pit experiment

TOXcontrol (gas sampling bag)

The contents of the gas sampling bag hardly displayed any toxicity, as assessed with the TOXcontrol system, which is based on the bio-luminescent bacterium *Vibrio fischeri*. Apparently, the concentration of chemicals is too low in the bag because sample collection had taken place outside the center of the smoke plume, or the gas bag constituents have reacted further to less toxic components.

CULTEX[®] (gas sample bag + open cups (A+B)).

No significant toxicity from the gas sampling bag was measured with the CULTEX[®] system. When open wells containing the lung cells were used, an effect was already measured even before the fire had started, probably due to an effect of the ventilation (± 1 m/sec) in the shelter. In previous studies on the toxicity of colored military smokes we had already encountered this phenomenon. Direct CULTEX[®] measurements, using open wells is therefore not a suitable method to be applied under realistic conditions.

3.6.2 Toxicity measurements during the second burn pit experiment

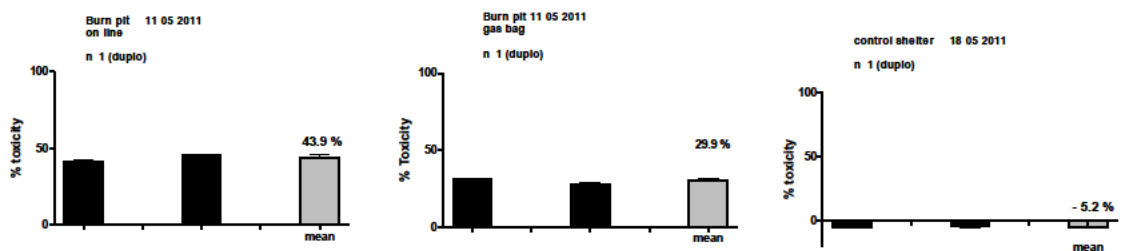

Figure 15 Response of TOXcontrol system during second burn pit experiment, when samples were taken within the smoke plume. Left panel: direct, on-line measurement; middle panel: indirect measurement, through gas sample bag, one day after sample collection; right panel: control air, measured on-line

During the second burn pit experiment the TOXcontrol system was used in two different ways. On the one hand, smoke air was lead through a suspension of the bacteria. In addition, smoke air was collected in a gas sampling bag, the contents of which were subsequently lead through the bacterium suspension under laboratory conditions. Subsequently, the luminescence of each bacterium suspension was determined in a 96-well plate. The entire procedure took 30 min. In both cases, a distinct effect of the smoke on the bacteria could be measured (see Figure 15).

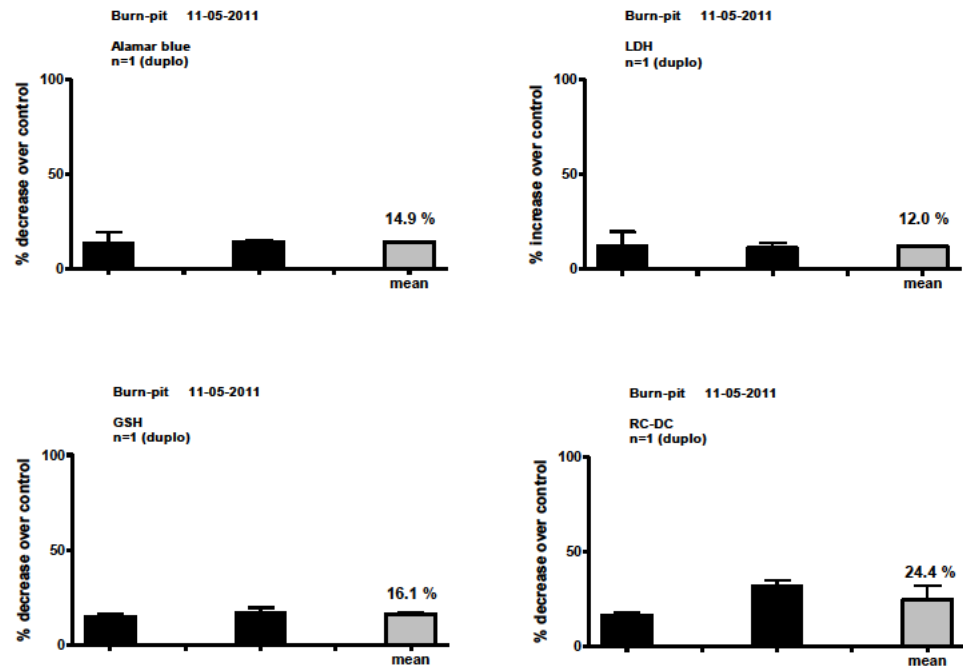

Figure 16 Response of A549 lung cells after exposure (8 ml/min/well; 1 h) to the contents of the gas bag, collected during the second burn pit experiment. Read-out biomarkers: Alamar Blue conversion (mitochondrial activity), LDH release (membrane damage), GSH concentration (oxidative stress) and RC-DC (protein content/apoptosis)

The results with the CULTEX[®] system demonstrate the suitability of A549 lung cells to detect toxic effects of smoke on human lung epithelial cells. For all biological end-point markers measured in the present study, significant changes could be assessed following a 1-h exposure to the smoke that had been collected in a gas sampling bag during the burn pit experiment. During the experiments it was reconfirmed that it was not feasible to use the system on-site: probably because of the environmental conditions, the lung cells had already died before the actual exposure had taken place.

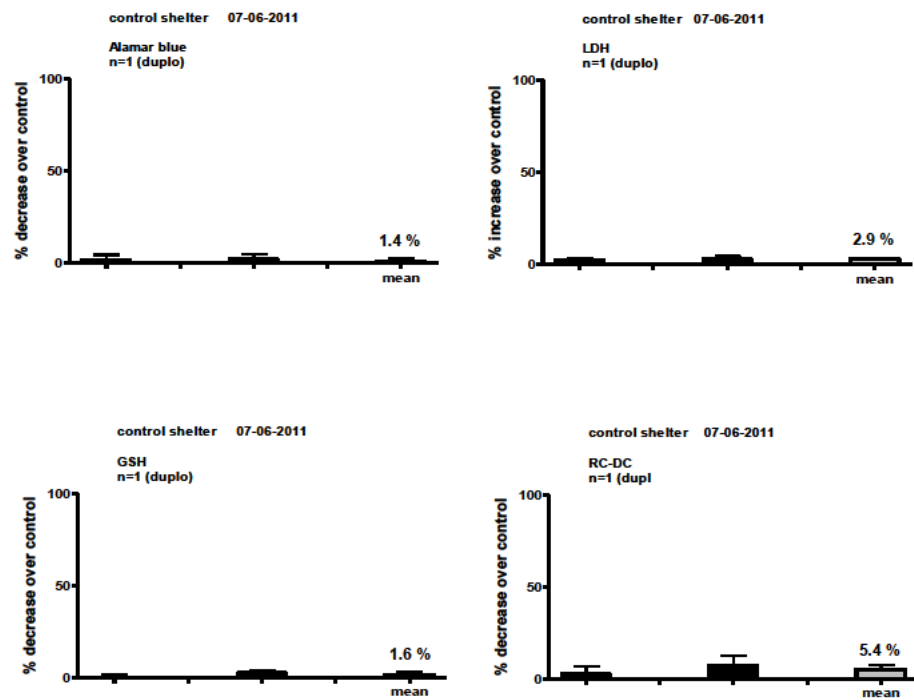

Figure 17 Response of A549 lung cells after exposure (8 ml/min/well; 1 h) to the contents of a gas bag, collected in a clean shelter (control experiment). Read-out biomarkers: Alamar Blue conversion (mitochondrial activity), LDH release (membrane damage), GSH concentration (oxidative stress) and RC-DC (protein content/apoptosis)

4 Conclusions

We have succeeded in developing an experimental set-up to mimic a so-called military 'burn pit', with the aim of exploring the utility of various kinds of analytical methods to detect and identify combustion products, as well as various biochemical techniques to determine the toxicity of the smoke constituents.

Although it should be stressed that interpretation of the analytical results is rather difficult, *inter alia* because of the wide variety of compounds that had been formed during the fire, the following preliminary conclusions can be drawn:

- Concentrations of a number of compounds (ammonia, CO, CO₂, NO, SO₂, HCN, HF, formaldehyde and phenol measured in the plume did not exceed threshold limit values. For hydrogen chloride and nitrogen dioxide the measured concentrations exceeded the MEG values for negligible effects, but not those for marginal effects, nor the respective ceiling and STEL values. This does not necessarily mean that personnel is not at risk when exposed for a short duration to the emission product of a burn pit. Exposure will occur to a mixture of chemical compounds, the toxicity of which may be much higher than that of the individual components. Unfortunately, the toxicity of a complex mixture such as emitted from burn pits cannot be predicted at the current state of the art in toxicology.
- E-Nose sensors are sensitive enough to rapidly (seconds!) respond to the evolved combustion products. In addition to their primary role as first warning system, they should also be extremely useful as 'switches' for analytical devices such as an HDS vial.
- Fieldable analytical methods as developed by us within the framework of program V936 are highly useful, especially in case of monitoring *within* the plume. Remarkably, outside the center of the plume, it turned out that mainly soot had been collected and that the concentrations of potentially toxic compounds were rather low. Nevertheless, based on the detection limits for HDS samplers and subsequent GC-MS analysis, and for E-nose sensors, it can be derived that measurements outside of the plume should also be feasible. Within this respect, it should be kept in mind that the Dutch MoD not only has to deal with scenario's involving high concentrations of chemicals, but also with long term – low level exposure scenarios. In this respect, the availability of highly sensitive methods is of crucial importance.
- GC-MS analysis of all collected samples showed the presence of a large number of aromatics and PAHs in significant quantities.
- Tenax and HDS showed comparable results for the volatiles, but for high boiling components Tenax proved to be more useful. For future experiments HDS vials should be heated prior to analysis.
- A tandem of E-nose sensors and HDS samplers might form a powerful combination for a sampling platform, with the rapidly responding sensor being the switch for the easy-to-use HDS.
- With regard to the toxicity monitoring methods, both the CULTEX[®] system and TOXcontrol gave a positive response when exposed, either directly on-site or in the laboratory by using collected gases. In contrast to the CULTEX[®] system, the TOXcontrol system could also be used directly, i.e., on site, for toxicity determinations. It remains to be seen, however, whether the sensitivity of the Cultex system is high enough to enable measurements outside of the plume.

Finally, it can be envisaged that the developed experimental set-up can play an important role in a variety of other experiments, designed to mimic chemical processes or accidents, and during which potentially toxic combustion products can be formed

5 References

- [1] CDC (2010) NIOSH Pocket Guide to Chemical Hazards
- [2] Committee on the Long-term Health consequences of exposure to burn pits in Iraq and Afghanistan. Long-term health consequences of exposure to Burn-pits in Iraq and Afghanistan. National Academies Press (Washington DC, USA), 2011.
- [3] U.S. Army Public Health Command (2010) Technical Guide 230: Environmental Health Risk Assessment and Chemical Exposure Guidelines for Deployed Military Personnel.

6 Signature

Rijswijk, March 2013

Earth, Environmental and Life Sciences



Head of department

Author

Appendix 1

Component		Tenax Bl. T=0	Tenax 6L T=0	Tenax gaszak
Sampled air volume (L)		30,00	6,00	6,00
Name	RT	µg/m3 Conc.	µg/m3 Conc.	µg/m3 Conc.
Benzene	4,385		18472,28	16082,24
Toluene	6,059	2,08	1292,77	1008,28
2,4-dimethylhexane	6,494			1,33
2,4-Dimethyl-1-heptene	7,282			1,55
Methyl-2-methoxypropenoate	7,544			3,66
Chorobenzene	7,605		16,31	9,13
Ethylbenzene	7,832	0,30	146,89	43,43
m,p-Xylene	8,013	0,62	216,41	51,96
o-Xylene	8,469			
Phenylethyne	8,148	0,90		146,78
Phenylethyne	8,176		379,85	25,24
Nonane	8,396	0,14		
Styrene	8,456	0,89	1788,60	623,49
Isopropylbenzene	9,041		22,50	2,05
n-Propylbenzene	9,628			
m-Ethyltoluene	9,755	0,18	18,80	3,75
p-Ethyltoluene	9,824	0,06		
1,2,3-trimethylbenzene	9,911			
Benzaldehyde	9,925	3,54	175,39	17,46
Phenol	10,106	0,48	201,05	18,99
2-Ethyltoluene	10,118			
2-Phenylpropene	10,174			4,24
α-Methylstyrene	10,189		87,90	
Decane	10,292	0,12		1,64
Benzonitrile	10,349	0,10	54,53	3,09
1,2,4-trimethylbenzene	10,416	0,16		
4-Ethylphenethylamine	10,432			4,99
1-Ethenyl-2-methylbenzene	10,454		59,53	0,00
Benzofuran	10,565	0,13	100,60	0,97
1,3,5-trimethylbenzene	10,967	0,11		
1,4-Diethylbenzene	10,981		14,47	
1-(2-Methylphenyl)ethanol	11,066		12,59	
Indane	11,285			
1-Propynylbenzene	11,511		357,87	4,37
p-Diethylbenzene	11,544			
n-Buthylbenzene	11,605			
Acetophenon	11,869		41,26	1,56
Undecane	12,102		10,98	
Nonanal	12,312			
1,3-diethenylbenzene	12,658		17,06	
1,2,4,5-Tetramethylbenzene	12,665			
1,2,3,5-Tetramethylbenzene	12,735			
1,4-dihydronaphthalene	13,403		20,94	

Vervolg Appendix 1

Component		Tenax Bl. T=0	Tenax 6L T=0	Tenax gaszak
Sampled air volume (L)		30,00	6,00	6,00
Name	RT	µg/m3 Conc.	µg/m3 Conc.	µg/m3 Conc.
Benzoic acid	13,451	4,01		2,17
Naphthalene	13,603		42,24	0,51
Decanal	14,042			2,27
Naphthalene	14,13	2,13	736,90	16,76
Benzothiophene	14,3		32,14	0,52
1-Methylnaphthalene	15,938	0,17	87,58	1,90
2-Methylnaphthalene	16,212	0,27	112,80	2,68
Biphenyl	17,176	0,36	224,27	2,00
2-Chloronaphthalene	17,344	0,08		
Biphenylene	17,63		39,81	
2-Ethenyl-naphthalene	17,732		15,20	
1,7-Dimethylnaphthalene	17,821		14,29	
1-(2-propenyl)-naphthalene	17,903		14,57	
Biphenyl	18,015		53,70	
Biphenylene	18,432		326,26	1,56
p-Methylbiphenyl	18,683		18,00	
4-Methylbiphenyl	18,846		11,78	
1-isocyanonaphthalene	19,01		13,10	
2-Naphthalenecarboxaldehyde	19,226		15,25	
Dibenzofuran	19,343		44,61	
Fluorene	20,012		7,66	
Fluorene	20,194		4,93	
Fluorene	20,274		37,37	
p-Phenylstyrene	20,379		6,38	
1,3-diphenylpropane	20,919		12,97	
diphenylethyne	21,089		4,81	
1-acenaphthylenone	21,331		5,62	
Dibenzosuberan-5-one	21,737		11,08	
9,10-Phenanthrenedione	22,342		7,15	
Anthracene	22,914		50,35	
1,2-diethyl-1,2dihydro-transanthracene	23,051		7,01	
1-Phenylnaphthalene	23,605		4,05	

Appendix 2

Name	Conc. (ppb)
Methylenecyclopropane	54
Methane, bromo-	52
Ethane, 1,1,2,2-tetrafluoro-	29
1-Buten-3-yne	404
Benzenethanamine, 2-fluoro-2',4,5-trihydroxy-N-methyl-	35
2-Methyl-3-oxobutyronitrile	327
Carbon disulfide	42
1-Butene, 3-methyl-	36
1,3-Butadiyne	57
Propiolonitrile	14
Isopropyl phosphine	28
Manganese(II) acetate	7254
Cyclopropane, ethylidene-	113
Bis(3-methylbutyl) fluorene-2,7-disulfonate	31
Glycine, N-(dithiocarboxy)-N-methyl-	58
Nitrobenzene, 2-bromo-4-methoxy-6-methoxymethoxy-	64
Isopropylamine hydrochloride	184
Cyclopropane, ethylidene-	69
2-Propenenitrile	106
Cyclopentene	229
1,3-Cyclopentadiene	229
Methylene Chloride	55299
Acetaldehyde, methylhydrazone	31
Ethenyl tert-butyl sulfoxide	23
1,3-Pentadiene, 3-methyl-, (E)-	41
1-Propanol, 3-(dimethylamino)-, acetate	41
Ethyl Acetate	22
2-(3-Chloropropyl)-1,3-dioxolane	28
Trichloromethane	43
1,4-Cyclohexadiene	37
1,3-Hexadien-5-yne	46
Benzene	10575
Thiophene	52
Acetic acid, butoxyhydroxy-, butyl ester	193
Benzene, chloro-	44
Ethylbenzene	160
p-Xylene	181
Phenylethyne	390
cis-4-Nonene	21
o-Xylene	43
Toluene	2099
BFB	5534
1,2,4-Benzenetricarboxylic acid, 1,2-dimethyl ester	43

Vervolg Appendix 2

Name	Con. (ppb)
Octane, 2,3,7-trimethyl-	43
(3H)Indazole, 3,3-dimethyl-	7
Benzene, 1,2,3-trimethyl-	20
Hydroxylamine, O-decyl-	20
Benzocyclobuten-1(2H)-one	16
Benzene, 1,2-propadienyl-	51
1,2,4-Benzenetricarboxylic acid, 1,2-dimethyl ester	49
Benzoic acid, 2-[(trimethylsilyl)oxy]-, trimethylsilyl ester	81
Naphthalene	33

Appendix 3

Name	Con. (ppb)
Benzedrex	27
Methane, bromo-	141
Ethane, 1,1,2,2-tetrafluoro-	49
3-Methyl-1-penten-4-yn-3-ol	84
1-Buten-3-yne	279
1,3-Butadiyne	150
Benzeneethanamine, 2-fluoro-á,3-dihydroxy-N-methyl-	41
Benzenethanamine, 2-fluoro-2',4,5-trihydroxy-N-methyl-	717
Decane, -1,10-diamino, -N,N,N',N'-tetramethyl	19312
Acetic acid, oxo-	1198
2H-1,3-Thiazin-4(3H)-one, 6-(2-selenolyl)-2-thioxo-	44913
1H-Imidazole-4-ethanamine, N,5-dimethyl-	6338
Ethanamine, 2-hydrazino-N,N-dimethyl-2-oxo-	94793
1,2-Pentadiene	139
1,3-Cyclopentadiene	248
2-Propenenitrile	71
Carbon disulfide	320
2-Propanol, 2-methyl-	26672
Methylene Chloride	41566
Pentadecylamine	156
1,4-Diacetoxy-trans-2-butene	365
Benzenemethanol, 2-(2-aminopropoxy)-3-methyl-	24
Tetrakis(methylsulfonyl)hydrazine	242
Pentane, 3-methyl-	167
[2-(N,N-Dimethyl)]-1,2-propanediamine	72
3-Buten-1-ol	27
Diisopropyl ether	1157
Furan, 3-methyl-	166
Ethyl Acetate	48
1,3-Pentadiene, 2-methyl-, (E)-	46
Furan, tetrahydro-	52
1,3-Hexadien-5-yne	17
4-Methylenecyclopentene	120
2-Propanamine	140
Oxirane, (1-methylbutyl)-	55
Benzene	6935
Thiophene	52
Methane, isocyanato-	68
cis-1-Methyl-2-propylcyclohexane	56
Heptane	25
Furan, tetrahydro-2,5-dimethyl-, trans-(ñ)-	51
2-Pentene, 3,4-dimethyl-	46
Toluene	1491
2-Propenamide, N-[2-(dimethylamino)ethyl]-	44
3-Hexen-2-one	118

Vervolg Appendix 3

Name	Con. (ppb)
Methanamine, 1-(dicyclohexylphosphino)-N,N-dimethyl-	14
3-Heptene, 4-propyl-	12
Hexane, 2,4-dimethyl-	247
3-Hexyne, 2,2-dimethyl-1-dimethylamino-	459
Heptane, 2,6-dimethyl-	79
Cyclopentane, 1-butyl-2-ethyl-	10
2,3,4-Trimethyl-hex-3-enal	121
Toluene	261
2-Propanamine, 2-methyl-	129
p-Xylene	292
Phenylethyne	178
1-Nonene	32
Ethylbenzene	939
o-Xylene	59
Decane, 2,5,6-trimethyl-	57
3-Penten-1-ol, 2,2,4-trimethyl-	29
BFB	4216
Bicyclo[3.1.1]hept-2-ene, 2,6,6-trimethyl-, (ñ)-	13
à-Methylstyrene	32
2-Undecene, 6-methyl-, (Z)-	29
Benzocyclobuten-1(2H)-one	28
3-Heptene, 2,2,4,6,6-pentamethyl-	41
Benzene, 1,4-dichloro-	12
Bicyclo[3.1.1]hept-2-ene, 3,6,6-trimethyl-	32
Indene	13
1H-Indene, 1-methylene-	21

UNCLASSIFIED
REPORT DOCUMENTATION PAGE
(MOD-NL)

1. DEFENCE REPORT NO (MOD-NL)	2. RECIPIENT'S ACCESSION NO	3. PERFORMING ORGANIZATION REPORT NO TNO 2012 R10732
4. PROJECT/TASK/WORK UNIT NO 032.18518	5. CONTRACT NO	6. REPORT DATE March 2013
7. NUMBER OF PAGES 36 (incl 3 appendices, excl RDP & distribution list)	8. NUMBER OF REFERENCES 3	9. TYPE OF REPORT AND DATES COVERED Final
10. TITLE AND SUBTITLE Evaluation of environmental and toxicity monitoring methods during improvised 'burn pits'		
11. AUTHOR(S) <div style="background-color: black; height: 20px; width: 100%;"></div>		
12. PERFORMING ORGANIZATION NAME(S) AND ADDRESS(ES) P.O. Box 45, 2280 AA Rijswijk, The Netherlands Lange Kleiweg 137, Rijswijk, The Netherlands		
13. SPONSORING AGENCY NAME(S) AND ADDRESS(ES)		
14. SUPPLEMENTARY NOTES The classification designation Ongerubrificeerd is equivalent to Unclassified, Stg. Confidentieel is equivalent to Confidential and Stg. Geheim is equivalent to Secret.		
15. ABSTRACT (MAXIMUM 200 WORDS (1044 BYTE)) The current report addresses the development of an experimental burn pit set up for testing and validating our asset of developed methods for environmental monitoring. Burn pits have been used routinely throughout missions, because other waste-disposal options were often not available or operational. It appeared that environmental monitoring by means of E-nose sensors are sensitive enough to rapidly (seconds) to the evolved combustion products. The various fieldable analytical methods proved to be useful especially when applied within the plume; outside of the plume the concentrations of potentially toxic compounds was rather low. With regard to the toxicity monitoring methods, both the CULTEX system and TOXControl gave a positive response, with the TOXControl system also applicable on site. It can be envisaged that the developed experimental set-up can also play an important role in a variety of other, more civil applications.		
16. DESCRIPTORS	IDENTIFIERS	
Environmental monitoring, burn pits, E-nose sensors, military toxicology		
17a. SECURITY CLASSIFICATION (OF REPORT) Unclassified	17b. SECURITY CLASSIFICATION (OF PAGE) Unclassified	17c. SECURITY CLASSIFICATION (OF ABSTRACT) Unclassified
18. DISTRIBUTION AVAILABILITY STATEMENT Subject to approval MOD-NL	17d. SECURITY CLASSIFICATION (OF TITLES) Unclassified	

UNCLASSIFIED

Distribution list

The following people or agencies will receive a complete copy of the report.

- 1 DMO/DR&D
including digital version supplied on cd-rom
- 2/3 DMO/DR&D/Kennistransfer
- 4 CDC/BGGZ/CEAG
including digital version supplied on cd-rom
██████████, apotheker, MPH
- 5 DMG / Hoofd SGB
- 6/8 NLDA
T.a.v. Bibliotheek KMA
- 9 Werkpakket begeleider ██████████ CEAG
- 10 TNO, location Rijswijk
██████████
- 11 TNO, location Rijswijk
██████████
- 12 TNO, location Rijswijk
██████████
- 13 TNO, location Rijswijk
██████████
- 14 TNO, location Rijswijk
██████████
- 15 TNO, location Rijswijk
██████████
- 16 TNO, location Rijswijk,
Archive, 1x loose-leaf example

The following people or agencies will receive a copy of the distribution list

- 4 ex. DMO/SC-DR&D
- 1 ex. DMO/resort Zeesystemen
- 1 ex. DMO/ressort Landsystemen
- 1 ex. DMO/ressort Luchtsystemen
- 2 ex. BS/DS/DOBBP/SCOB
- 1 ex. MIVD/AAR/BMT

TNO, Directeur Thema Defence, Safety & Security

[REDACTED]

TNO, Directeur Innovatiegebied Defence Research

[REDACTED]

TNO, Propositiemanager MPMM

[REDACTED]

TNO, Propositiemanager ASARA

[REDACTED]

TNO, Directeur Life Sciences

[REDACTED]

TNO, S&P

[REDACTED]