

IMPLEMENTATION PLAN



Rail Freight Corridor 1 Zeebrugge- Antwerp/Rotterdam-Duisburg-[Basel]-Milan-Genoa

The information contained in this document is solely of general nature and is not legally binding. This is the public version V1.0 approved by the Executive Board of ministries. This document is property of the infrastructure managers of RFC 1. No extracts from this document may be used by other parties.

Contents

| | | |
|-----------|---|-----------|
| 1 | INTRODUCTION | 8 |
| 2 | CORRIDOR DESCRIPTION | 9 |
| 2.1 | CORRIDOR LINES..... | 9 |
| 2.1.1 | Routing..... | 9 |
| 2.1.2 | Traffic Demand..... | 14 |
| 2.1.3 | Bottlenecks..... | 18 |
| 2.1.4 | Available Capacity..... | 19 |
| 2.1.5 | Planned Investments Related to Bottleneck Removal..... | 21 |
| 2.2 | CORRIDOR TERMINALS..... | 22 |
| 3 | TRANSPORT MARKET STUDY | 26 |
| 3.1 | TMS – PREAMBLE..... | 26 |
| 3.2 | SHORT-TERM STUDY..... | 26 |
| 3.3 | LONG-TERM STUDY..... | 36 |
| 3.4 | IMPORTANT INVESTMENTS IN RAIL FREIGHT CORRIDOR 1 UNTIL 2025..... | 39 |
| 3.5 | FIRST PROPOSALS ON ROUTING AND TERMINALS..... | 40 |
| 4 | MEASURES | 40 |
| 4.1 | MEASURES RELATED TO THE REGULATION (EU) No 913/2010..... | 40 |
| 4.1.1 | Cross-border Coordination of Infrastructure Works..... | 40 |
| 4.1.2 | Corridor One-Stop-Shop (C-OSS)..... | 41 |
| 4.1.3 | Framework for Capacity Allocation..... | 44 |
| 4.1.4 | Authorised Applicants..... | 44 |
| 4.1.5 | Traffic Management Procedures..... | 44 |
| 4.1.6 | Traffic Management in the Event of Disturbance..... | 44 |
| 4.1.7 | Performance Management..... | 45 |
| 4.2 | MEASURES IN ADDITION TO REGULATION (EU) No 913/2010..... | 48 |
| 4.2.1 | Continuing Activities for Improving the Quality on the Corridor by the Ministries (IQ-C action plan)..... | 48 |
| 4.2.2 | Objectives and Action Plan of the National Safety Authorities (NSAs) of RFC 1..... | 50 |
| 4.2.3 | Action Plan of the Regulatory Bodies of RFC 1..... | 51 |
| 5 | OBJECTIVES/PERFORMANCE | 52 |
| 5.1 | OBJECTIVES FOR RFC 1..... | 52 |
| 5.2 | KPIs FOR MONITORING THE ABOVE OBJECTIVES..... | 52 |
| 5.3 | DEFINITIONS OF THE KPIs..... | 53 |
| 5.4 | PERFORMANCE MONITORING REPORT..... | 61 |
| 5.5 | CUSTOMER SATISFACTION SURVEY..... | 61 |
| 6 | INVESTMENT PLAN | 62 |
| 6.1 | CAPACITY MANAGEMENT PLAN..... | 62 |
| 6.2 | INFRASTRUCTURE PROJECTS AND TIMELINE..... | 65 |
| 7 | INTEROPERABILITY | 70 |
| 7.1 | ERTMS IMPLEMENTATION PLAN..... | 70 |
| 7.1.1 | Introduction..... | 70 |
| 7.1.2 | Description of Sections to be Equipped with ERTMS..... | 73 |
| 7.1.3 | Description of ERTMS Sections with Reference to TSI CCS (Corridor A)..... | 75 |
| 7.1.4 | Description of RFC 1 ERTMS Sections According to the Regulation (EU) No 913/2010..... | 79 |
| 7.1.5 | ERTMS Implementation with Reference to TSI CCS (EDP)..... | 82 |
| 7.1.5.1 | The Netherlands..... | 82 |
| 7.1.5.1.1 | Description of Corridor Lines..... | 82 |
| 7.1.5.1.2 | ETCS Deployment..... | 84 |

| | | |
|-------------|--|-----|
| 7.1.5.1.2.1 | Technical Standards, Baseline, Levels | 84 |
| 7.1.5.1.2.2 | Class B Systems in Use | 85 |
| 7.1.5.1.2.3 | National Technical Requirements for Vehicles | 87 |
| 7.1.5.1.2.4 | Network Access Conditions..... | 87 |
| 7.1.5.1.2.5 | Testing and Authorisation..... | 87 |
| 7.1.5.1.3 | ETCS Roll out plan | 87 |
| 7.1.5.1.3.1 | Installation | 89 |
| 7.1.5.1.3.2 | Testing and Putting in Service..... | 89 |
| 7.1.5.1.3.3 | Detailed Description of ETCS Equipment on Dutch Part of Border Section Zevenaar Oost (NL) - Emmerich (DE) | 89 |
| 7.1.5.1.3.4 | Investments | 91 |
| 7.1.5.2 | Belgium | 92 |
| 7.1.5.3 | Germany..... | 92 |
| 7.1.5.3.1 | Description of Corridor Lines | 92 |
| 7.1.5.3.2 | ETCS Deployment..... | 94 |
| 7.1.5.3.2.1 | Technical Standards, Baseline, Levels | 94 |
| 7.1.5.3.2.2 | Class B Systems in Use | 94 |
| 7.1.5.3.2.3 | National Technical Requirements for Vehicles | 95 |
| 7.1.5.3.2.4 | Network Access Conditions..... | 96 |
| 7.1.5.3.2.5 | Testing and Authorisation..... | 96 |
| 7.1.5.3.3 | ETCS Roll Out Plan..... | 98 |
| 7.1.5.3.3.1 | Installation | 99 |
| 7.1.5.3.3.2 | Testing and Putting in Service..... | 100 |
| 7.1.5.3.3.3 | Detailed Description of ETCS Equipment on German Part of Border Section Zevenaar–Oost (NL) – Emmerich (DE) | 101 |
| 7.1.5.3.3.4 | Detailed Description of ETCS Equipment on the Border Section Weil am Rhein (DE) – Basel SBB (CH), Including German Lines Within Swiss Territory | 104 |
| 7.1.5.3.3.5 | Investments | 107 |
| 7.1.5.4 | Switzerland..... | 108 |
| 7.1.5.4.1 | Description of Corridor Lines | 108 |
| 7.1.5.4.2 | ETCS Deployment..... | 110 |
| 7.1.5.4.2.1 | Technical Standards, Baseline, Levels | 110 |
| 7.1.5.4.2.2 | Class B Systems in Use | 112 |
| 7.1.5.4.2.3 | National Technical Requirements for Vehicles | 112 |
| 7.1.5.4.2.4 | Network Access Conditions..... | 113 |
| 7.1.5.4.2.5 | Testing and Authorisation..... | 114 |
| 7.1.5.4.3 | ETCS Roll Out Plan..... | 115 |
| 7.1.5.4.3.1 | Installation | 119 |
| 7.1.5.4.3.2 | Testing and Putting in Service..... | 120 |
| 7.1.5.4.3.3 | Detailed Description of ETCS Equipment on Swiss Part of Border Sections Switzerland - Italy | 120 |
| 7.1.5.4.3.4 | Investments | 123 |
| 7.1.5.5 | Italy | 124 |
| 7.1.5.5.1 | Description of Corridor Lines | 124 |
| 7.1.5.5.2 | ETCS Deployment..... | 126 |
| 7.1.5.5.2.1 | Technical Standards, Baseline, Levels | 126 |
| 7.1.5.5.2.2 | Class B Systems in Use | 126 |
| 7.1.5.5.2.3 | National Technical Requirements for Vehicles | 126 |
| 7.1.5.5.2.4 | Network Access Conditions..... | 126 |
| 7.1.5.5.2.5 | Testing and Authorisation..... | 127 |
| 7.1.5.5.3 | ETCS Roll Out Plan..... | 128 |
| 7.1.5.5.3.1 | Installation | 129 |
| 7.1.5.5.3.2 | Testing and Putting in Service..... | 129 |
| 7.1.5.5.3.3 | Detailed Description of ETCS Equipment on Italian Part of Border Sections Switzerland - Italy..... | 129 |
| 7.1.5.5.3.4 | Investments | 134 |
| 7.1.6 | ERTMS Implementation with Reference to Regulation (EU) No 913/2010 | 135 |
| 7.1.6.1 | The Netherlands..... | 135 |
| 7.1.6.1.1 | Description of Corridor Lines | 135 |
| 7.1.6.1.2 | Migration Goals and Strategy for the Network..... | 135 |

| | | |
|---|--|------------|
| 7.1.6.2 | Belgium | 136 |
| 7.1.6.2.1 | Description of Corridor Lines | 136 |
| 7.1.6.2.2 | Migration Goals and Strategy for the Network | 137 |
| 7.1.6.2.3 | Impact on ETCS Equipment of Vehicles..... | 139 |
| 7.1.6.2.4 | Requirements for Roll Out, Testing and Authorisation | 140 |
| 7.1.6.2.5 | ETCS Investments | 141 |
| 7.1.6.3 | Germany..... | 142 |
| 7.1.6.3.1 | Description of Corridor Lines | 142 |
| 7.1.6.3.2 | Migration Goals and Strategy for the Network | 142 |
| 7.1.6.3.3 | Impact on ETCS Equipment of Vehicles..... | 142 |
| 7.1.6.3.4 | Requirements for Roll Out, Testing and Authorisation | 142 |
| 7.1.6.3.5 | ETCS Investments | 142 |
| 7.1.6.4 | Switzerland..... | 143 |
| 7.1.6.4.1 | Description of Corridor Lines | 143 |
| 7.1.6.4.2 | Migration Goals and Strategy for the Network | 143 |
| 7.1.6.4.3 | Impact on ETCS Equipment of Vehicles..... | 146 |
| 7.1.6.4.4 | Requirements for Roll Out, Testing and Authorisation | 146 |
| 7.1.6.4.5 | ETCS Investments | 146 |
| 7.1.6.5 | Italy | 146 |
| 7.1.6.5.1 | Description of Corridor Lines | 146 |
| 7.1.6.5.2 | Migration Goals and Strategy for the Network | 147 |
| 7.1.6.5.3 | Impact on ETCS Equipment of Vehicles..... | 147 |
| 7.1.6.5.4 | Requirements for Roll Out, Testing and Authorisation | 147 |
| 7.1.6.5.5 | ETCS Investments | 147 |
| REFERENCE TO UNION CONTRIBUTION | | 148 |
| ANNEX 1 LIST OF RAIL FREIGHT CORRIDOR LINES..... | | 149 |

Figures

| | |
|---|-----|
| FIGURE 1: LEGEND FOR THE NEXT FIGURES REGARDING CORRIDOR LINES AND TERMINALS | 9 |
| FIGURE 2: CORRIDOR LINES AND TERMINALS IN THE NETHERLANDS..... | 10 |
| FIGURE 3: CORRIDOR LINES AND TERMINALS IN BELGIUM..... | 10 |
| FIGURE 4: CORRIDOR LINES AND TERMINALS IN GERMANY (OVERVIEW)..... | 11 |
| FIGURE 5: CORRIDOR LINES AND TERMINALS IN GERMANY (DETAIL DUISBURG)..... | 11 |
| FIGURE 6: CORRIDOR LINES AND TERMINALS IN GERMANY (DETAIL COLOGNE)..... | 12 |
| FIGURE 7: CORRIDOR LINES AND TERMINALS IN GERMANY (DETAIL MANNHEIM)..... | 12 |
| FIGURE 8: CORRIDOR LINES AND TERMINALS IN SWITZERLAND | 13 |
| FIGURE 9: CORRIDOR LINES AND TERMINALS IN ITALY..... | 13 |
| FIGURE 10: CORRIDOR LINES AND TERMINALS IN ITALY (DETAIL GENOA)..... | 14 |
| FIGURE 11: QUANTITY OF EXPECTED FREIGHT TRAINS PER DAY (SUM OF BOTH DIRECTIONS) ON RFC 1 IN 2015..... | 15 |
| FIGURE 12: NUMBER OF FREIGHT TRAINS PER DAY (SUM OF BOTH DIRECTIONS) ON RFC 1 IN 2020..... | 16 |
| FIGURE 13: PROJECTED QUANTITY OF FREIGHT TRAINS PER DAY (SUM OF BOTH DIRECTIONS) ON RFC 1 IN 2025..... | 17 |
| FIGURE 14: BOTTLENECKS ON RFC 1 IN 2012..... | 18 |
| FIGURE 15: COUNTED QUANTITY OF FREIGHT TRAINS (SUM OF BOTH DIRECTIONS) ON RFC 1 ON THE MEASURING DAY 27. SEP 2012,... | 20 |
| FIGURE 16: TERMINALS AND MARSHALLING YARDS IN THE NETHERLANDS | 22 |
| FIGURE 17: TERMINALS AND MARSHALLING YARDS IN BELGIUM..... | 23 |
| FIGURE 18: TERMINALS AND MARSHALLING YARDS IN GERMANY..... | 23 |
| FIGURE 19: TERMINALS AND MARSHALLING YARDS IN SWITZERLAND..... | 24 |
| FIGURE 20: TERMINALS AND MARSHALLING YARDS IN ITALY | 24 |
| FIGURE 21: EXAMPLE OF TERMINAL TEMPLATE | 25 |
| FIGURE 22: IMPORTANT INFRASTRUCTURE INVESTMENTS UNTIL 2015, BASED ON THE PRELIMINARY ROUTING OF 2012 | 39 |
| FIGURE 23: TIMELINE AND WORKING STRUCTURE FOR COORDINATION OF WORKS | 41 |
| FIGURE 24: IMPORTANT STEPS OF PERFORMANCE MANAGEMENT..... | 45 |
| FIGURE 25: TRAIN INFORMATION SYSTEM (TIS) | 46 |
| FIGURE 26: INVOLVEMENT OF CUSTOMERS | 46 |
| FIGURE 27: IMPROVEMENTS IN CAPACITY WHEN ALL SECURED PROJECTS UNTIL 2015 WILL BE IMPLEMENTED ON RFC 1..... | 62 |
| FIGURE 28: IMPROVEMENTS IN CAPACITY WHEN ALL PROJECTS UNTIL 2020 ARE CONSIDERED ON RFC 1 | 63 |
| FIGURE 29: IMPROVEMENTS IN CAPACITY WHEN ALL PROJECTS UNTIL 2025 ARE CONSIDERED ON RFC 1 | 64 |
| FIGURE 30: CORRIDOR SECTIONS (CONSOLIDATED) ACCORDING TO THE DEFINITION OF RFC 1 | 73 |
| FIGURE 31: CORRIDOR SECTIONS TO BE EQUIPPED WITH ERTMS ACCORDING TO TSI CCS..... | 75 |
| FIGURE 32: CORRIDOR SECTIONS TO BE EQUIPPED WITH ERTMS ACCORDING REGULATION (EU) NO 913/2010..... | 79 |
| FIGURE 33: MAP OF ETCS DEPLOYMENT IN THE NETHERLANDS..... | 82 |
| FIGURE 34: BETUWEROUTE - HAVENSPOORLIJN..... | 83 |
| FIGURE 35: DETAIL VIEW OF ZEVENAAR..... | 84 |
| FIGURE 36: ETCS ROLL OUT PLAN IN THE NETHERLANDS | 88 |
| FIGURE 37: POWER SUPPLY AND SIGNALLING SYSTEMS ON THE BORDER SECTION ZEVENAAR – EMMERICH (PRORAIL) | 89 |
| FIGURE 38: PHASE 1 OF ETCS ROLL OUT ON THE BORDER SECTION ZEVENAAR OOST AND EMMERICH (PRORAIL)..... | 90 |
| FIGURE 39: PHASE 2 OF ETCS ROLL OUT AND INSTALLATION OF 3 RD TRACK ON THE BORDER SECTION NL/DE (PRORAIL) | 91 |
| FIGURE 40: MAP OF ETCS DEPLOYMENT IN GERMANY..... | 92 |
| FIGURE 41: MAP OF ETCS DEPLOYMENT IN GERMANY (DETAIL OBERHAUSEN/DUISBURG)..... | 93 |
| FIGURE 42: MAP OF ETCS DEPLOYMENT IN GERMANY (DETAIL COLOGNE)..... | 93 |
| FIGURE 43: MAP OF ETCS DEPLOYMENT IN GERMANY (DETAIL MANNHEIM)..... | 94 |
| FIGURE 44: ETCS ROLL OUT PLAN IN GERMANY..... | 98 |
| FIGURE 45: ERTMS BORDER CROSSING NL/D | 99 |
| FIGURE 46: ERTMS TARGET SITUATION BORDER D/CH | 100 |
| FIGURE 47: POWER SUPPLY AND SIGNALLING SYSTEMS ON THE BORDER SECTION ZEVENAAR – EMMERICH (DB NETZ)..... | 102 |
| FIGURE 48: STEP ONE OF ETCS ROLL OUT ON THE BORDER SECTION ZEVENAAR OOST AND EMMERICH (DB NETZ)..... | 102 |
| FIGURE 49: STEP TWO OF ETCS ROLL OUT ON THE BORDER SECTION ZEVENAAR OOST AND EMMERICH (DB NETZ) | 102 |
| FIGURE 50: STEP THREE OF ETCS ROLL OUT ON THE BORDER SECTION ZEVENAAR OOST AND EMMERICH (DB NETZ) | 103 |

FIGURE 51: STEP FOUR OF ETCS ROLL OUT AND INSTALLATION OF 3RD TRACK ON THE BORDER SECTION ZEVENAAR OOST AND EMMERICH 103

FIGURE 52: NODE OF BASEL ETCS L1LS IN NORTH-SOUTH DIRECTION (HIGHLIGHTED IN ORANGE)..... 105

FIGURE 53: NODE OF BASEL ETCS L1 LS IN SOUTH-NORTH DIRECTION (HIGHLIGHTED IN ORANGE) 106

FIGURE 54: NODE OF BASEL ETCS L2 DIRECTION SOUTH – SORTH (HIGHLIGHTED IN BLUE)..... 106

FIGURE 55: MAP OF ETCS DEPLOYMENT IN SWITZERLAND 108

FIGURE 56: DETAILED VIEW OF RFC 1 IN SWITZERLAND 109

FIGURE 57: COMPARISON SIGNUM/ZUB AND ETCS 110

FIGURE 58: VEHICLE OPERATION..... 111

FIGURE 59: NODE OF BASEL BORDER SECTION D/CH (SBB) 111

FIGURE 60: LIFE CYCLE OF CLASS B SYSTEMS IN SWITZERLAND..... 112

FIGURE 61: ETCS ROLL OUT PLAN IN SWITZERLAND..... 115

FIGURE 62: ETCS L2 LINES ALREADY IN SERVICE IN SWITZERLAND 116

FIGURE 63: FURTHER ETCS ROLLOUT IN SWITZERLAND 117

FIGURE 64: ETCS LINES IN CONSTRUCTION 117

FIGURE 65: ETCS LEVEL 2 LINES UNDER CONSTRUCTION 118

FIGURE 66: MIGRATION YEARS..... 119

FIGURE 67: ETCS LEVEL 2 ON GOTTHARD-CENERI AXIS 119

FIGURE 71: INSTALLATION OF SIGNALLING SYSTEMS AT CHIASSO (SBB) 121

FIGURE 72: STATE BORDER AT CHIASSO STATION 121

FIGURE 73: OPERATIONAL HANDOVER AT CHIASSO..... 122

FIGURE 74: INTERLOCKING INTERFACE AT CHIASSO’S BORDER SECTION 122

FIGURE 75: CHANGE OF INFRASTRUCTURE PROPERTIES WITH REGARD TO AN ETCS-EQUIPMENT 123

FIGURE 76: ERTMS CORRIDOR LINES IN ITALY ACCORDING TO TSI CCS (EDP) 124

FIGURE 77: CURRENT PLANNING ERTMS CORRIDOR LINES IN ITALY ACCORDING TO TSI CCS (EDP) 125

FIGURE 78: CURRENT PLANNING ERTMS CORRIDOR LINES IN ITALY ACCORDING TO TSI CCS [EDP (DETAIL GENOVA)] 125

FIGURE 79: ETCS ROLL OUT PLAN IN ITALY 128

FIGURE 69: INSTALLATION OF SIGNALLING SYSTEM ON BORDER SECTION BRIG – DOMODOSSOLA I AND II..... 130

FIGURE 70: INSTALLATION OF SIGNALLING SYSTEMS ON RANZO – LUINO LINE 132

FIGURE 84: ETCS ROLL OUT PLAN IN BELGIUM 140

FIGURE 85: ETCS LEVELS ON RFC 1 IN BELGIUM 141

FIGURE 86: UPGRADING WITH ETM..... 144

FIGURE 87: COMPARISON SIGNUM/ZUB AND ETCS 144

FIGURE 88: VEHICLE OPERATION..... 144

FIGURE 89: ETCS LEVEL 1 AND LEVEL 2 IN SWITZERLAND..... 145

FIGURE 90: EXTENSION OF ETCS LEVEL 2 IN SWITZERLAND 146

Tables

| | |
|--|-----|
| TABLE 1: SPECIFICATION FOR THE IMPROVEMENT OF QUALITY ON RFC 1 | 48 |
| TABLE 2: RFC 1 INDICATIVE INVESTMENT PLAN | 69 |
| FIGURE 31: GENERAL LEGEND OF MAPS SHOWING ERTMS DEPLOYMENT ON RFC 1..... | 74 |
| TABLE 4: ERTMS SECTIONS WITH REFERENCE TO TSI CCS | 79 |
| TABLE 5: ERTMS SECTIONS ACCORDING TO THE REGULATION (EU) NO 913/2010..... | 81 |
| TABLE 6: DETAILS BETUWEROUTE - HAVENSPORLIJN..... | 83 |
| TABLE 7: BORDER SECTION BRIG – DOMO EQUIPMENT WITH OTHER COMPATIBLE SIGNALLING SYSTEMS | 131 |
| TABLE 8: STATIONS EQUIPPED WITH EUROBALISSES ON RANZO – LUINO LINE (ERTMS SECTIONS WITH REFERENCE TO TSI CCS)..... | 133 |
| TABLE 9: CORRIDOR LINES TO BE EQUIPPED WITH ERTMS IN BELGIUM | 136 |
| TABLE 10: ESTIMATED ETCS INVESTMENTS ON RFC 1 (ALL TYPES OF LINES)..... | 141 |
| TABLE 11: UNION CONTRIBUTION ON CORRIDOR A/1 ROTTERDAM - GENOA | 148 |
| TABLE 12: LIST OF CORRIDOR LINES | 155 |

Disclaimer: The sole responsibility of this publication lies with the author. The European Union is not responsible for any use that may be made of the information therein.

1 Introduction

The vision of a Europe wide transport network without frontiers shall be based on rail freight corridors. The adoption of the Regulation (EU) No 913/2010 concerning a European rail network for competitive freight is a major step in realising this vision. This Regulation was adopted by the European Parliament and the Council on 22 September 2010 and entered into force on 9 November 2010. It was elaborated with the overall purpose to increase rail freight's attractiveness and efficiency with special focus on international traffic, so that rail can increase its competitiveness and market share on the European transport market. In order to achieve this, the Regulation has the general objective to improve the conditions for international rail freight transport by reinforcing cooperation at all levels – and especially among infrastructure managers – along selected rail freight corridors, with the twofold aim

- (1) To develop the rail freight corridors in terms of capacity and performance in order to meet market demand both quantitatively and qualitatively.
- (2) To lay the ground for providing freight services of good quality meeting customer expectations.

The initial nine rail freight corridors as defined in the Annex of the Regulation are expected to form a European-wide network for competitive freight, making not only cooperation between infrastructure managers within each corridor, but also among them, essential.

Rail Freight Corridor 1 (RFC 1) runs from Rotterdam to Genoa along the River Rhine through the industrial heart of Europe and is connected to Zeebrugge and Antwerp via Cologne and builds on the existing ERTMS Corridor A.

The “Implementation Plan” describes the measures foreseen for the further development which are intended by the ministries, infrastructure managers, allocation bodies involved in RFC 1 on the basis of national decisions and deployment plans.

These measures will be realised by the Management Board of the Corridor, which is composed of representatives of ProRail, Infrabel, DB Netz, SBB, BLS, Trasse Schweiz and RFI. An appropriate structure of working groups has been created to execute the corridor programme.

This will happen in cooperation with the Advisory Groups for railway undertakings and terminal owners and operators, which have been established.

The implementation is in the responsibility of the ministries of transport from the Netherlands, Belgium, Germany, Switzerland and Italy, who mandate the relevant infrastructure managers and allocation bodies, to perform the related works.

The present Implementation Plan describes the corridor routing/terminals and contains the essential elements from the transport market study. The chapter “Measures” deals with the coordinated information on infrastructure works, inauguration of a one-stop-shop, authorised applicants and traffic management. In the chapter “Investment Plan” projects planned for the following years on the Corridor are listed, including the financial contributions by the EU.

All the information given in this implementation plan is indicative and legally non-binding.

2 Corridor Description

2.1 Corridor Lines

2.1.1 Routing

The RFC 1 stretches from the sea ports of Rotterdam, Zeebrugge and Antwerp to the port of Genoa, right through the heart of the EU along the so-called "Blue Banana". This is the most heavily industrialised North-South route in Central Europe and connects Europe's prime economic regions. The "Blue Banana" includes major ports and economically strong urban centres such as Rotterdam, Amsterdam, Zeebrugge, Ghent, Antwerp, Duisburg, Cologne, Mannheim, Basle, Milan and Genoa. All these centres are served and connected by the Corridor. The countries directly involved are The Netherlands, Belgium, Germany, Switzerland and Italy.

This outstanding position together with the resulting fact that this corridor carries by far the greatest transport volume in Europe makes RFC 1 the most important part of the rail transport network in Europe.

The corridor routing is mainly based on the annex of the Regulation (EU) No 913/2010 and on the European Deployment Plan (Decision 2012/88/EU). The defined lines are derived from the results of the transport market study which describes the expected traffic demand for the upcoming years.

The following graphics describe the corridor lines and the corridor terminals. All railway lines of RFC 1 are listed in Annex 1 (Table 12: and terminals in chapter "Corridor Terminals" (figure 16 to figure 20). Until finalisation of the ERTMS planning for Rail Freight Corridor 1 all maps and figures shown are indicative in relation to the deployment of ERTMS.

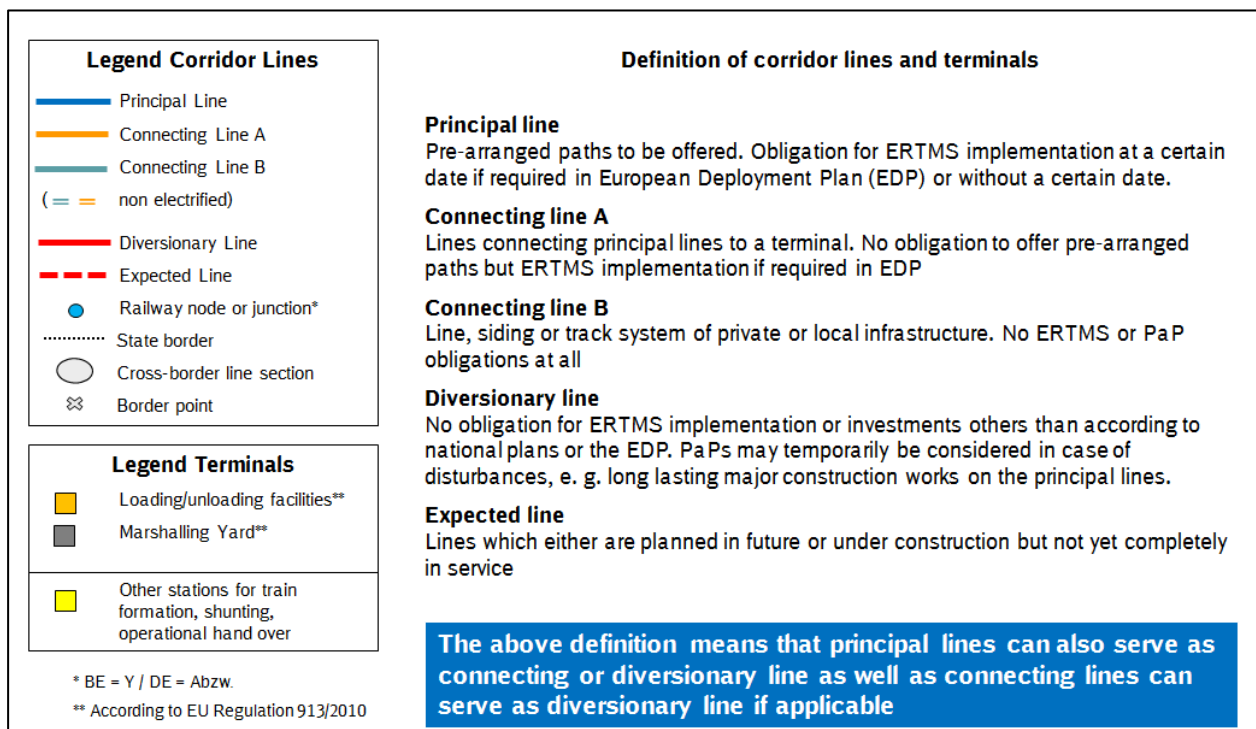

Figure 1: Legend for the next figures regarding corridor lines and terminals

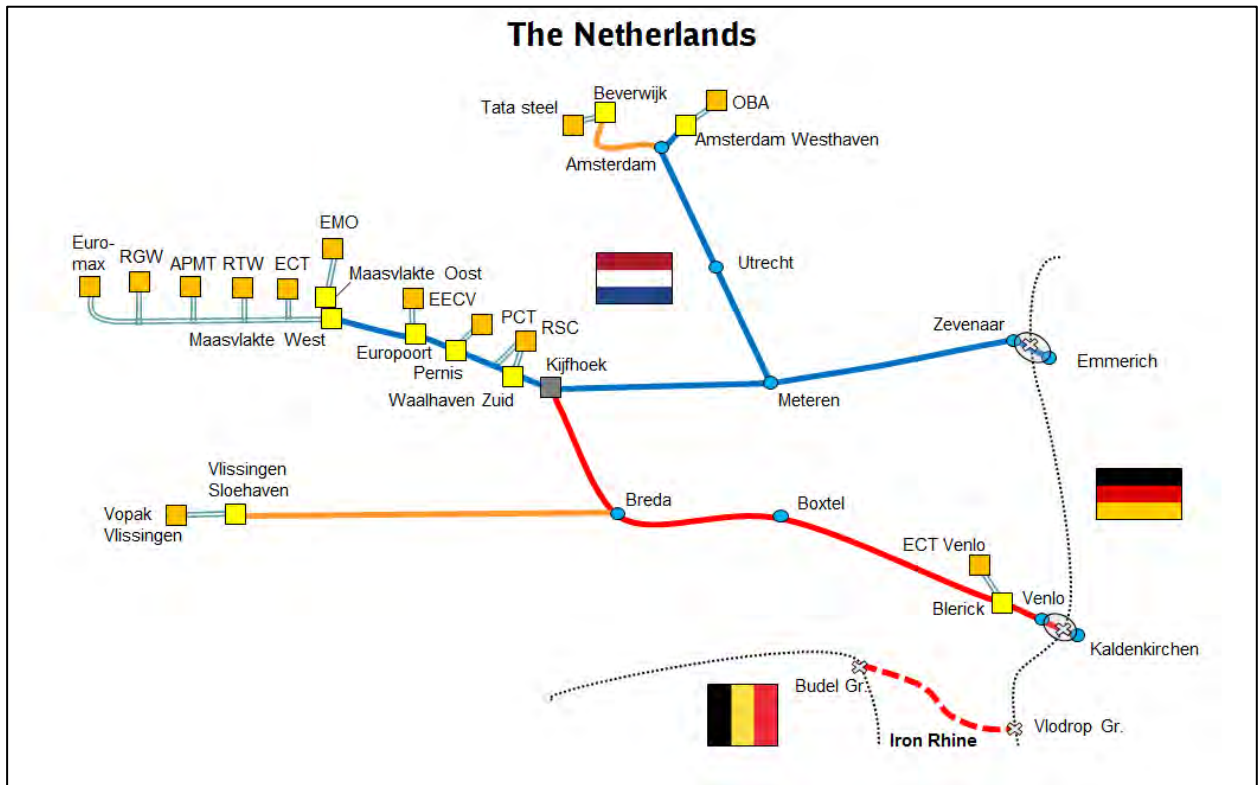

Figure 2: Corridor lines and terminals in the Netherlands

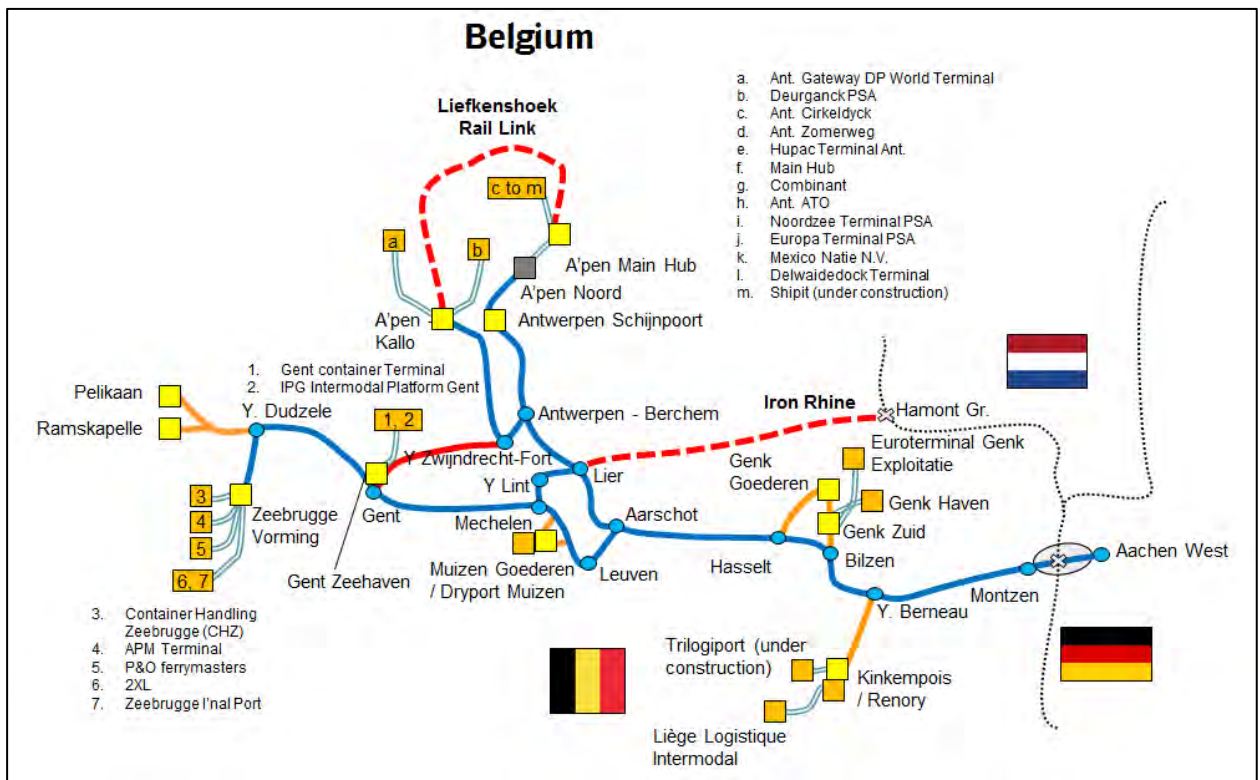

Figure 3: Corridor lines and terminals in Belgium

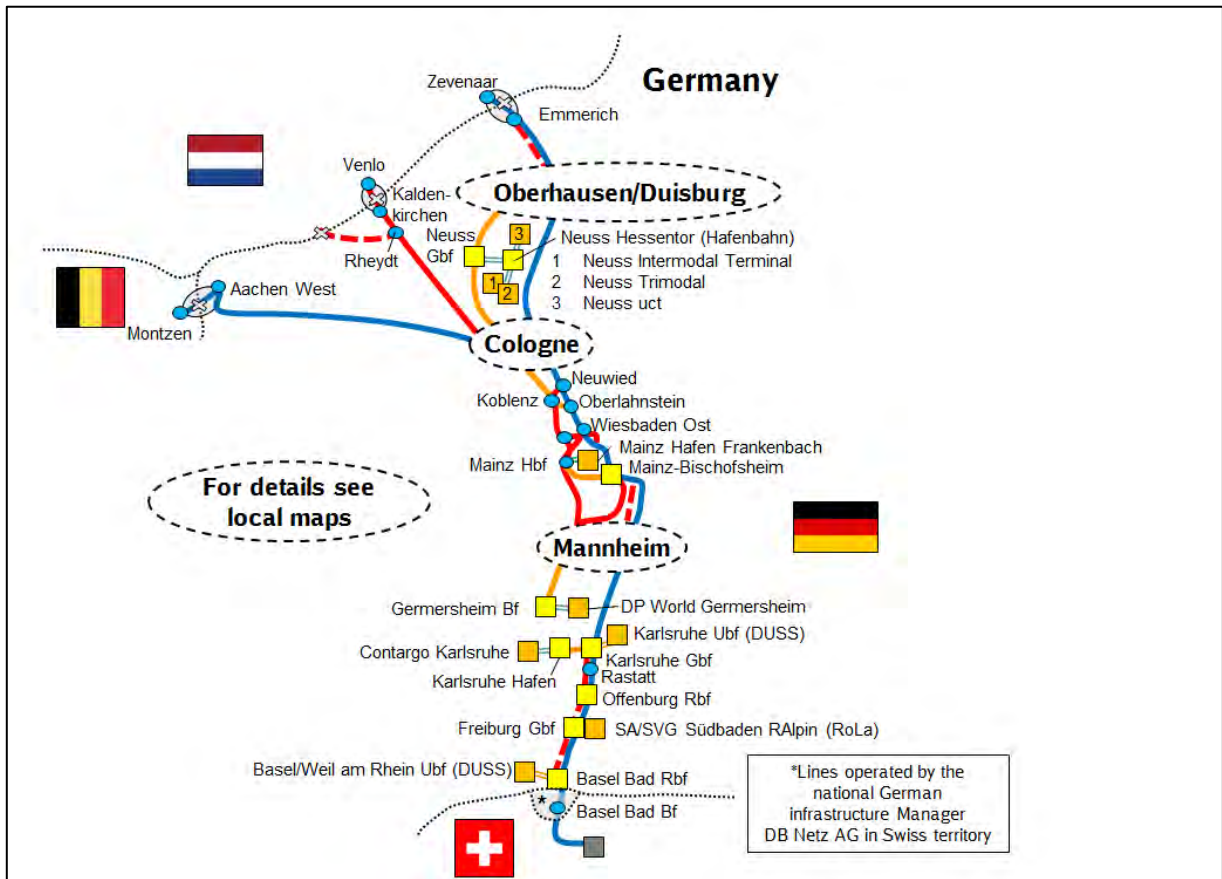

Figure 4: Corridor lines and terminals in Germany (overview).
 The map details shown do not necessarily correspond to the EDP



Figure 5: Corridor lines and terminals in Germany (detail Duisburg).
 The map details shown do not necessarily correspond to the EDP

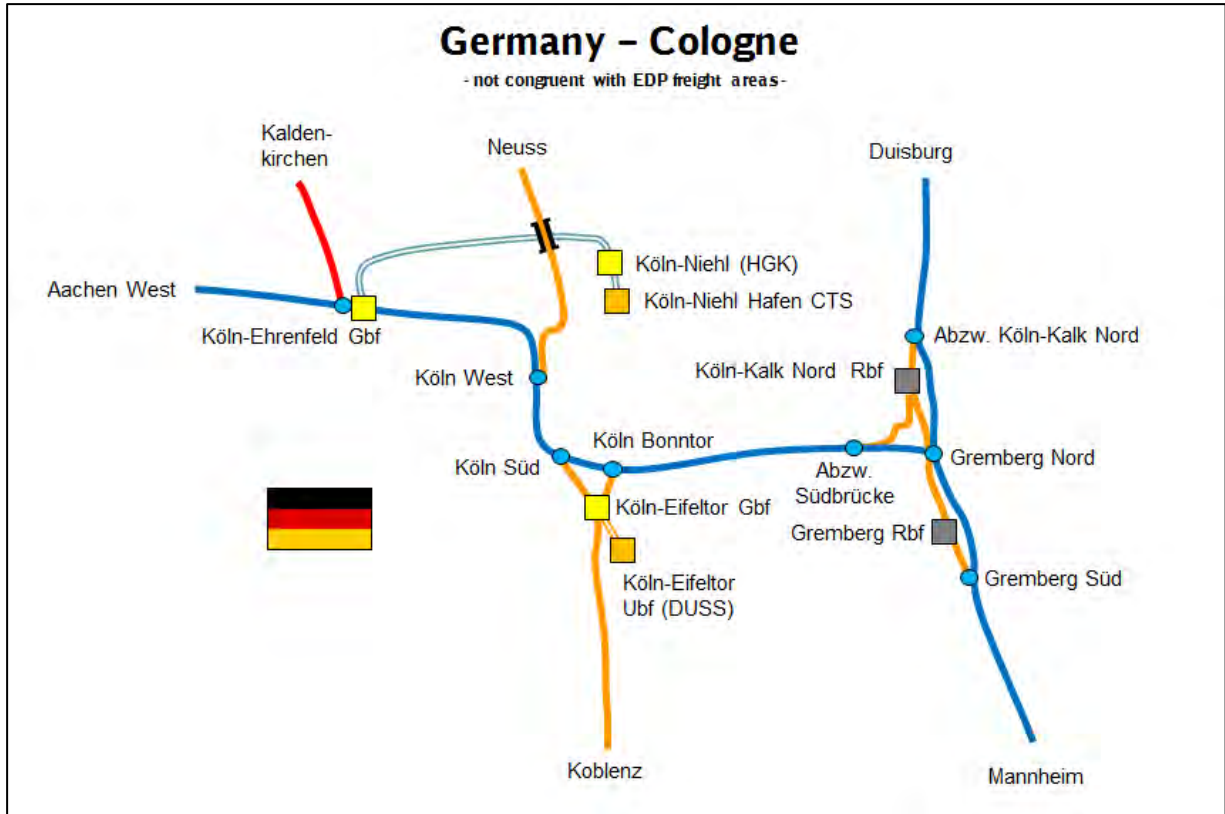

Figure 6: Corridor lines and terminals in Germany (detail Cologne).

The map details shown do not necessarily correspond to the EDP



Figure 7: Corridor lines and terminals in Germany (detail Mannheim).

The map details shown do not necessarily correspond to the EDP

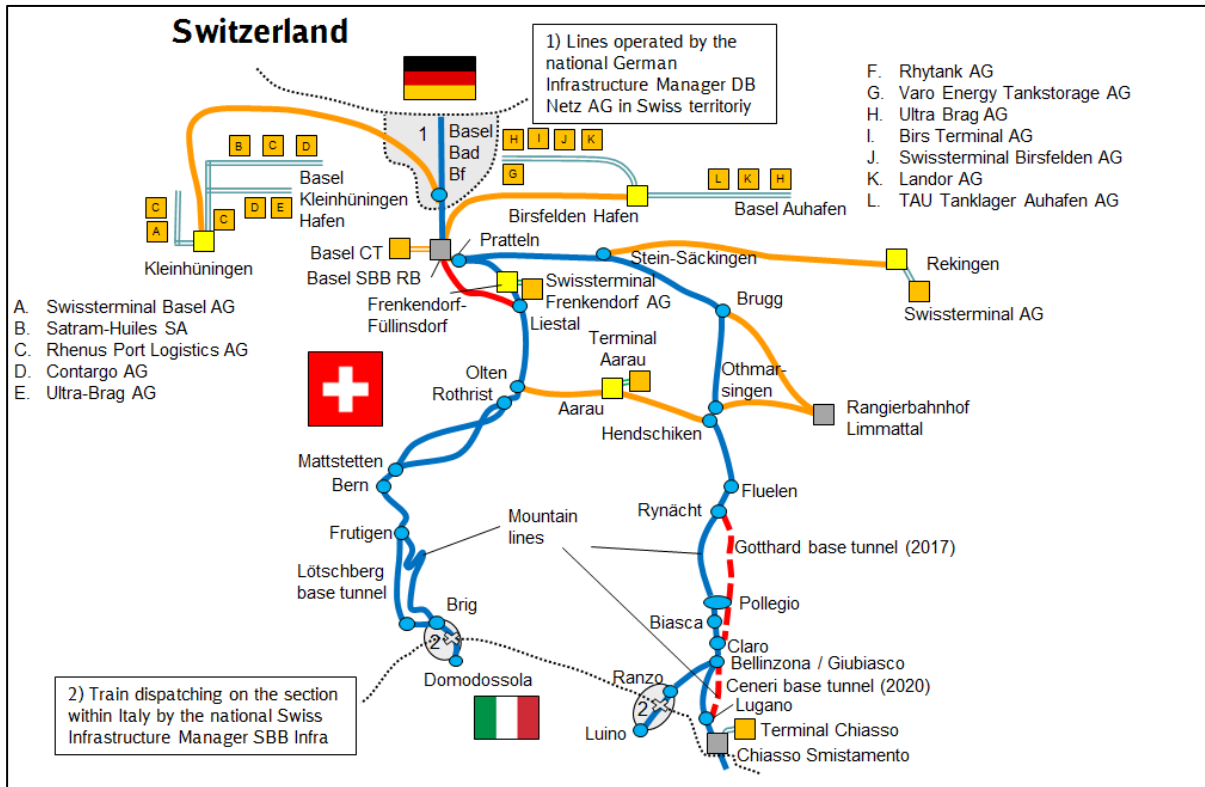

Figure 8: Corridor lines and terminals in Switzerland

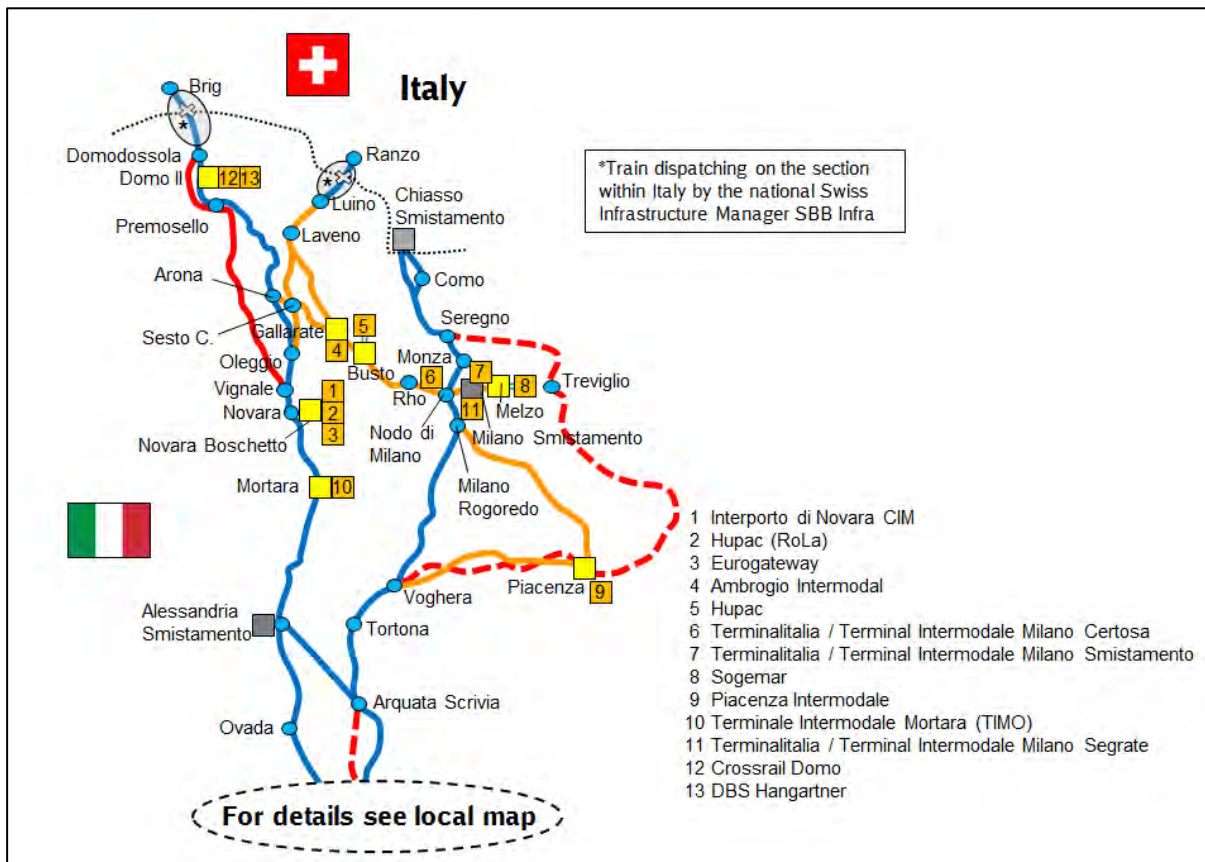

Figure 9: Corridor lines and terminals in Italy.

Italian MoT and RFI provide for ERTMS deployment and pre-arranged path offer on connecting and diversionary lines following EDP respectively market demand.

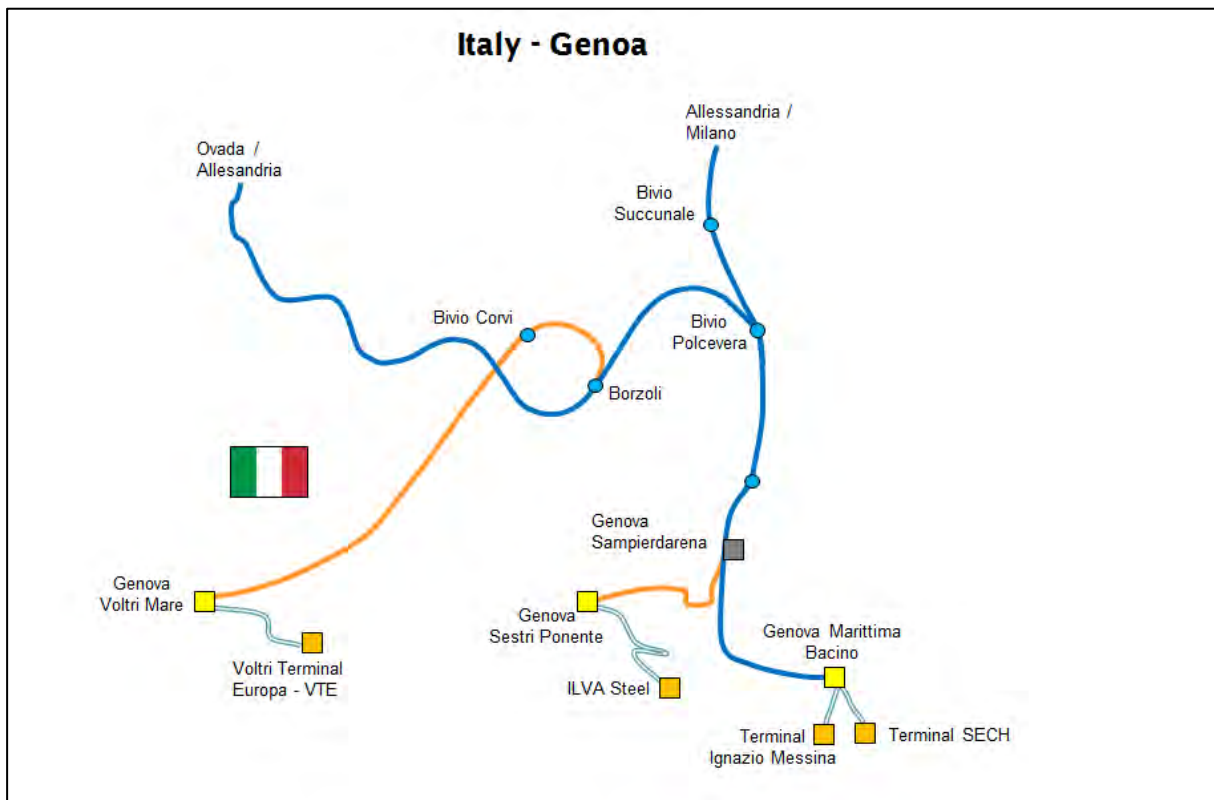

Figure 10: Corridor lines and terminals in Italy (detail Genoa).

Italian MoT and RFI provide for ERTMS deployment and pre-arranged path offer on connecting and diversionary lines following EDP respectively market demand.

2.1.2 Traffic Demand

The evaluation of rail freight traffic within the scope of the Transport Market Study of RFC 1 has resulted that different kinds of freight trains run on the Corridor. Of all the corridor freight trains, 56% are intermodal trains, 24% are single wagon trains and 20% are block trains.

The expected demand for freight trains per section is shown in Figure 11 to Figure 13 for the years 2015 to 2025. The numbers are based on the Transport Market Study of RFC 1.

The widths of the lines represent the number of trains on the Corridor, where the range is always 50 trains. Additionally, the colours in Figure 12 and Figure 13 show the difference in quantity of trains in % compared to the figures from the previous five years.

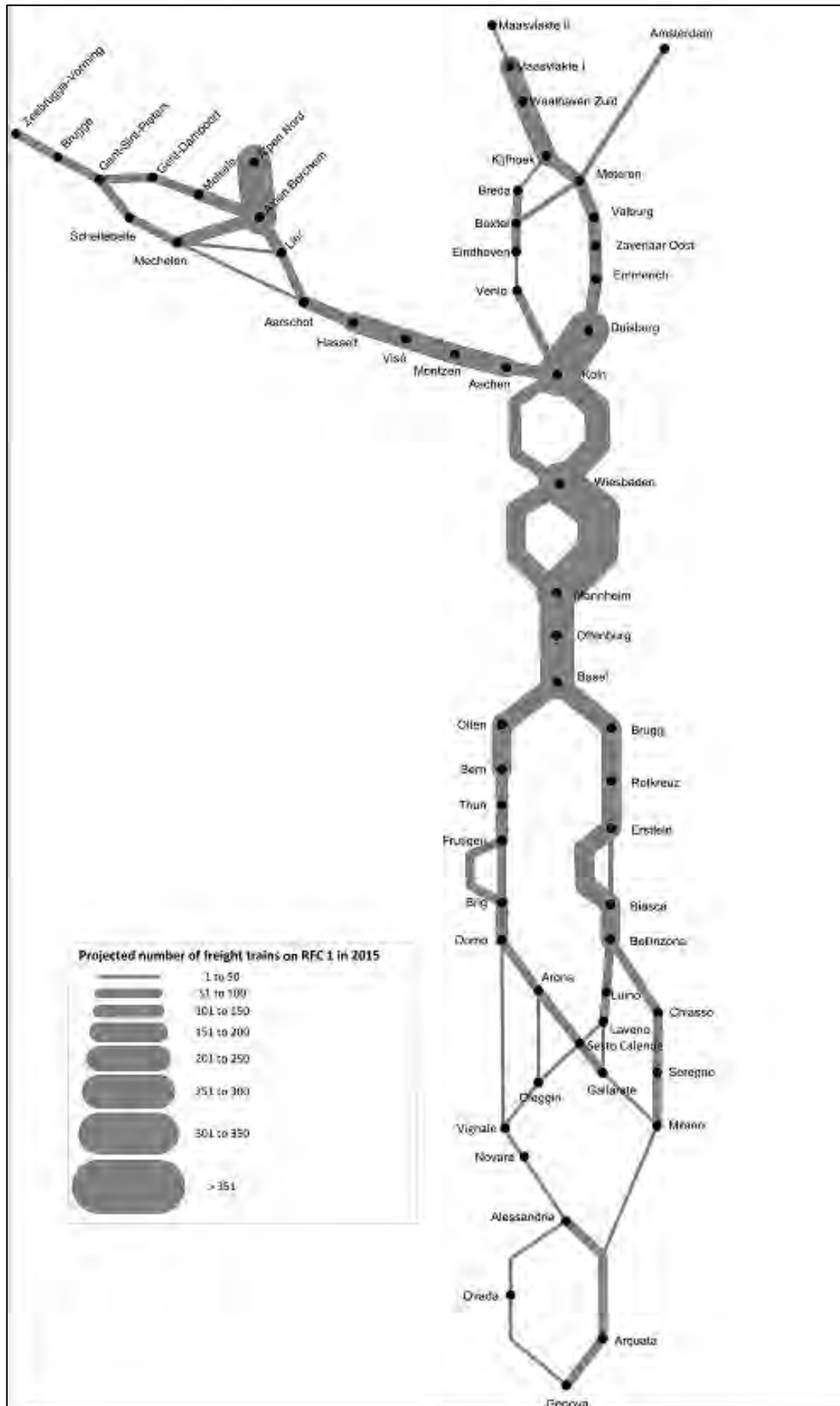

Figure 11: Quantity of expected freight trains per day (sum of both directions) on RFC 1 in 2015. A range of 50 trains is represented by the width of the lines in every section of the Corridor, based on the preliminary routing of 2012. Source: Analysis by WG Infrastructure & Terminals.

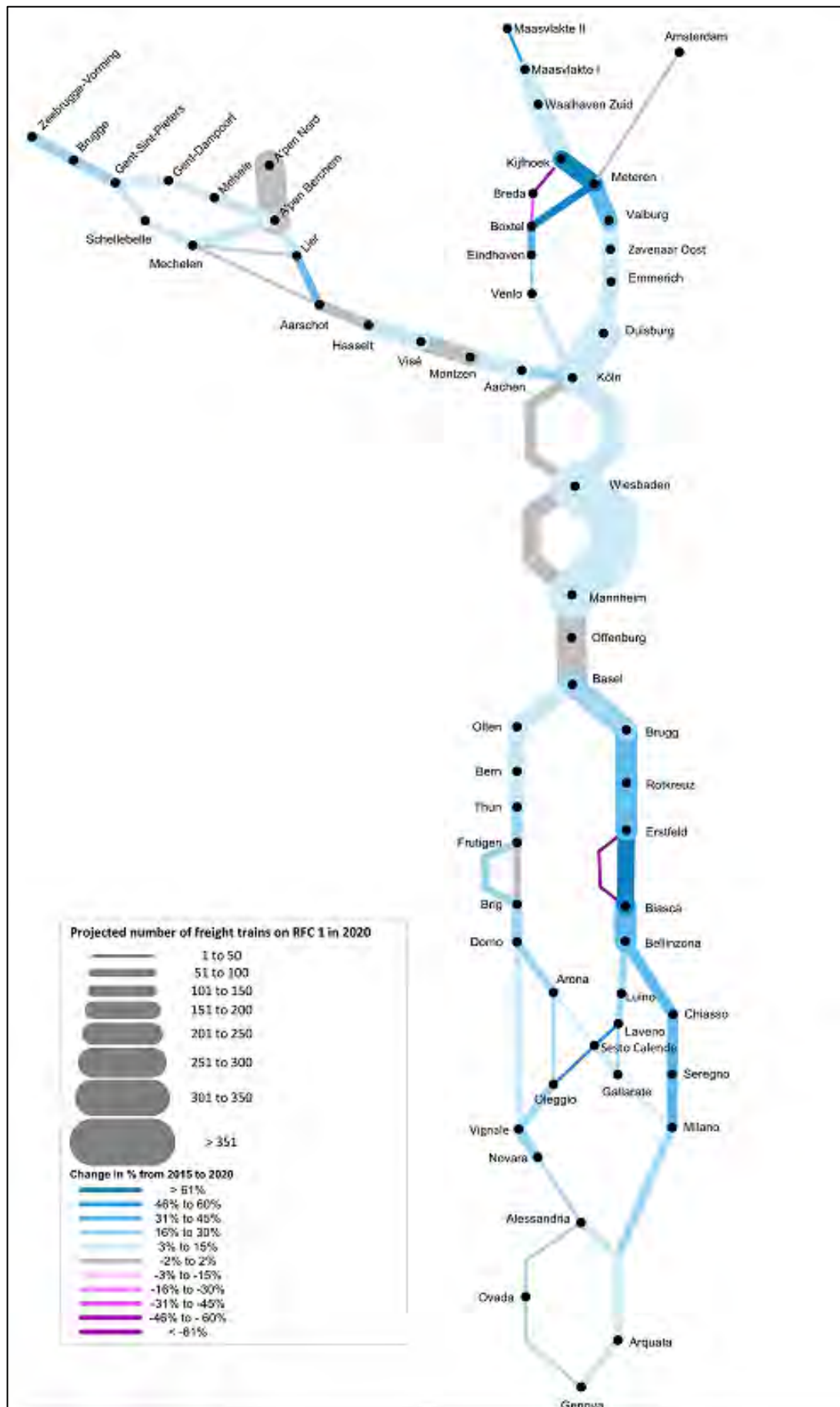

Figure 12: Number of freight trains per day (sum of both directions) on RFC 1 in 2020

A range of 50 trains is represented by the width of the lines in every section of the Corridor, based on the preliminary routing of 2012. The colours indicate the differences in quantity of trains in comparison to the figures of 2015. Source: Transport Market Study RFC 1, 2013.

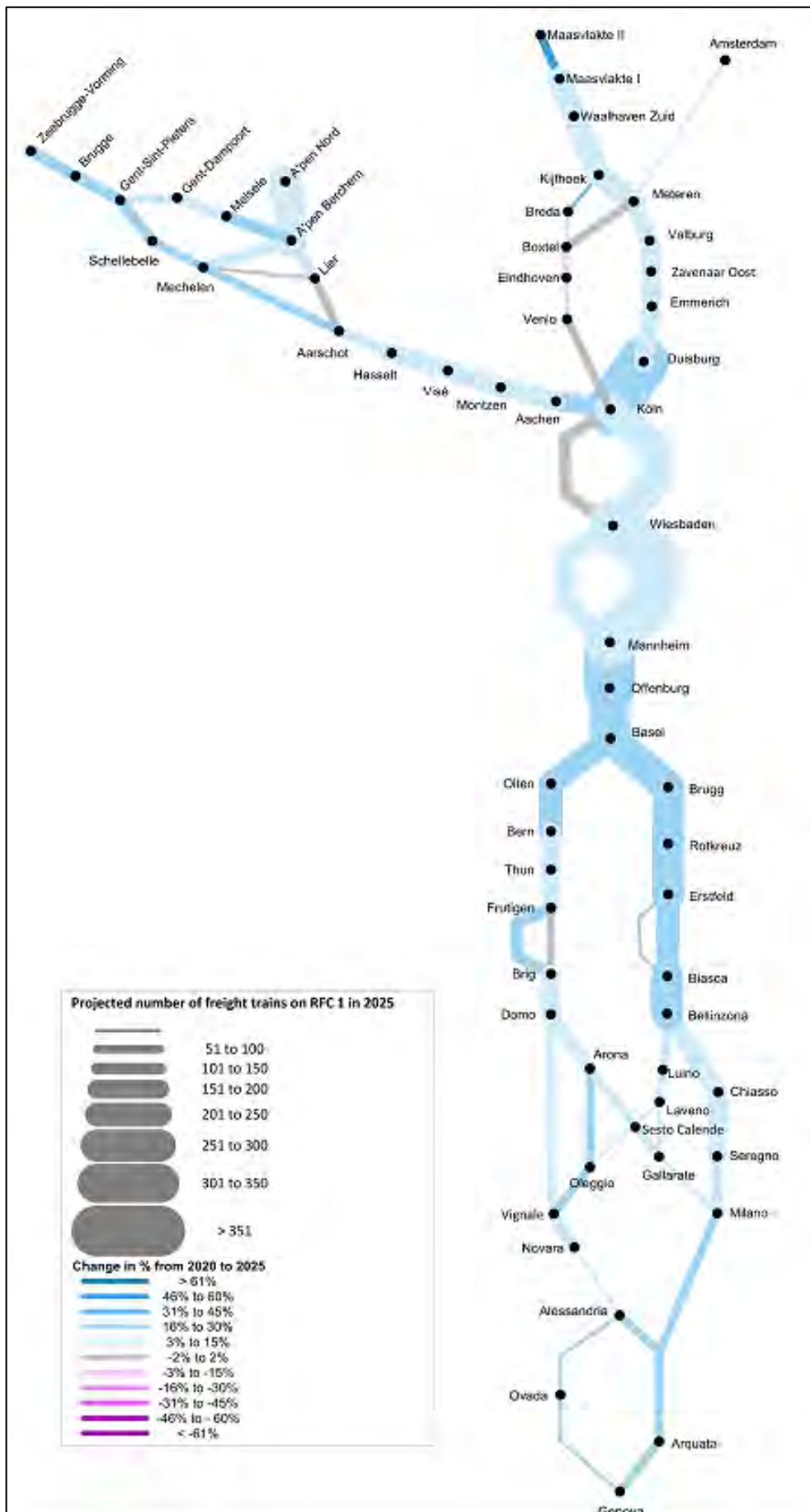

Figure 13: Projected quantity of freight trains per day (sum of both directions) on RFC 1 in 2025

A range of 50 trains is represented by the width of the lines in every section of the Corridor, based on the preliminary routing of 2012. The colours indicate the difference in quantity of trains in comparison to the figures of 2020. Source: Transport Market Study RFC 1, 2013.

2.1.3 Bottlenecks

Generally, bottlenecks are defined as sections on the Corridor, where the total traffic demand of freight trains and passenger trains exceeds the available capacity including consideration of capacity used for maintenance works per section. The methodology for recognising and defining bottlenecks is subject of every ministry of transport respectively infrastructure manager (IM) and therefore it can differ. This is without prejudice of Art. 47 of the Directive 2012/34/EU. The similarity in these national capacity studies is that the expected capacity demand of freight and passenger trains in a section is compared with the momentarily available capacity. In case bottlenecks are detected, the solution for their elimination is carried out by national studies for instance by increasing the capacity, or lowering the quality of the train paths, respectively rerouting trains. This information per line section is delivered by each IM and all these national information put together gives the bottleneck information for the Corridor.

Figure 14 shows the bottlenecks marked in red on the Corridor in 2012.

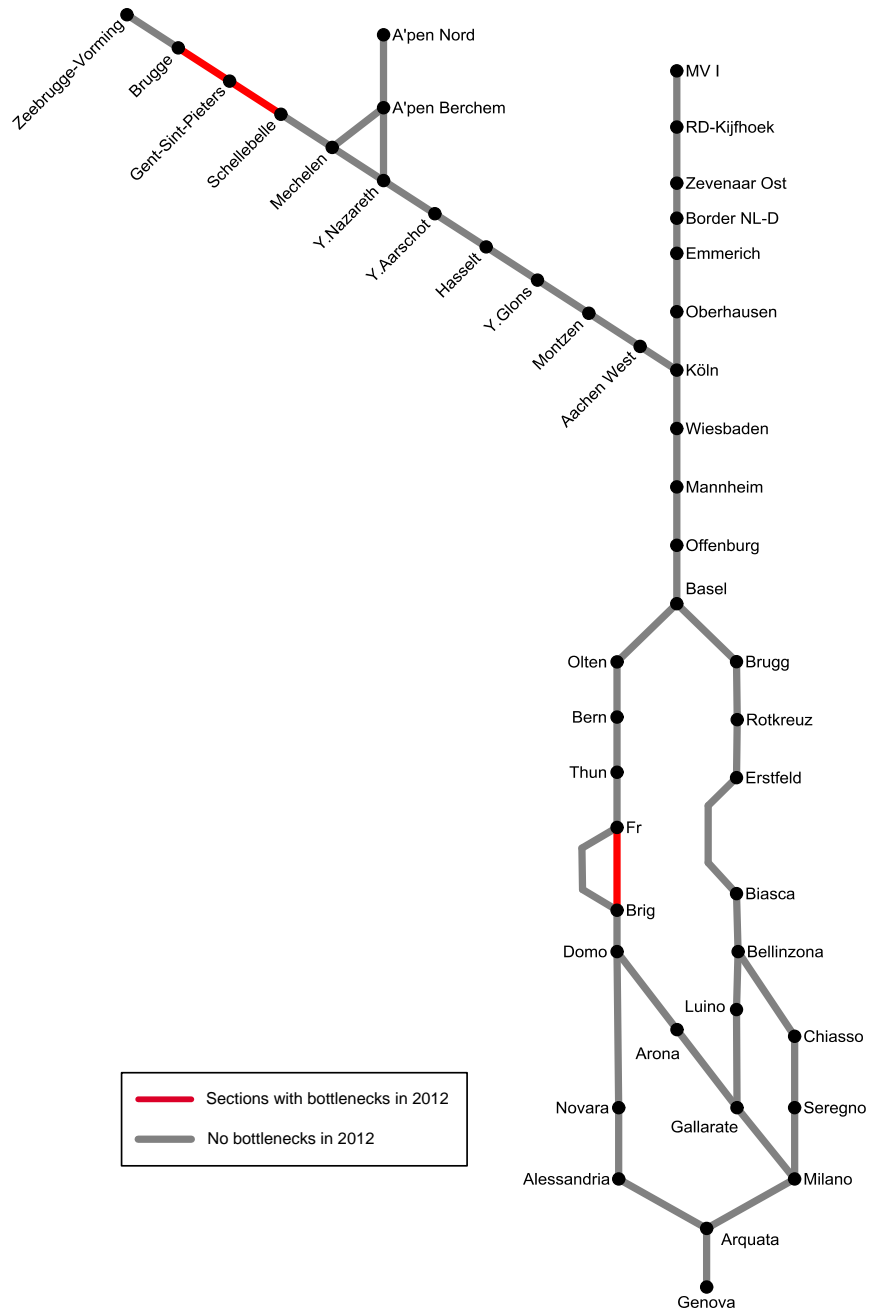

Figure 14: Bottlenecks on RFC 1 in 2012

Basis: Analysis February 2011, based on the preliminary routing of 2011

2.1.4 Available Capacity

Since most of the sections are considerably long, the available capacity may vary within one single section. For bottleneck analysis, the smallest capacity is chosen for the entire section and not the average capacity. The following study is based on this principle.

The chosen approach to determine the available capacity on the Corridor is made by illustrating the quantity of measured freight trains on one measuring day. The measuring day is set on the last Thursday in September, because this day usually has the most representative traffic volumes the whole year through.

The quantity of trains, shown in Figure 15, illustrate the capacity which was available on the measuring day, 27th September 2012, and are used to calculate the available capacity of freight trains on all corridor sections.

Study on Long Trains (740m)

On RFC 1, it was studied to enable the operation of 740m long trains by providing at least 750 meters long tracks according to the UN ECE AGC recommended standard on train length. This is without prejudice to the competence of the Member States regarding infrastructure planning and financing. Also this is without prejudice to any financial commitment of a Member State.

Subsequently, a corridor working group was set up in summer 2012 to execute the study until end of 2013.

First, the working group assessed today's line sections regarding track and effective train length. For the last mile an additional inventory was set up with "handover points" to private infrastructure and to terminals. Furthermore, the operational maximum train length was also assessed for important relations.

Second step was the evaluation of customer's demand, which includes an analysis of the potential for operating long trains (740m) by using modern standard traction equipment.

On a further development of the study, the investment plan will be taken into account for the consideration of future infrastructure improvements, which will also result in increasing the usable train length. For the remaining corridor sections, the working group will analyse the additional efforts needed to facilitate the operation of trains with a length of 740m.

The objective of the study is also to assess Quick Wins for those relations where trains of 740m can be achieved at short term. In this respect, operations and timetable construction will be also considered.

The study is intended to be completed by the end of 2013, and its results will be presented to the Executive Board of RFC 1.



Figure 15: Counted quantity of freight trains (sum of both directions) on RFC 1 on the measuring day 27. Sep 2012, based on the preliminary routing of 2012

2.1.5 Planned Investments Related to Bottleneck Removal

Planned investments related to bottleneck removal and the associated projects can be found under chapter "0 Infrastructure Projects and Timeline".

These infrastructure projects are displayed as projects that run under the category "Capacity" as part of their benefit to the railway system in the mentioned list.

2.2 Corridor Terminals

In the Regulation (EU) No 913/2010, article 2, §2c terminals are defined as follows. “Terminal mean the installation provided along the freight corridor which has been specially arranged to allow either the loading and/or the unloading of goods onto/from freight trains, and the integration of rail freight services of road, maritime, river and air services, and either the forming or modification of the composition of freight trains; and where necessary performing border procedures at borders with European third countries.”

According to this and the results of the Transport Market Study, the ministries of transport together with the IMs from the participant countries have designated terminals along the RFC 1 that shall be considered and involved in the development of the Corridor.

The following list of terminals is sorted by country from North to South.

| Country | Terminal | Handover station |
|---------|----------------------------------|----------------------|
| NL | APMT | Maasvlakte West |
| | ECT | Maasvlakte West |
| | Euromax | Maasvlakte West |
| | RTW | Maasvlakte West |
| | EMO | Maasvlakte Oost |
| | RSC | Waalhaven Zuid |
| | OBA | Amsterdam Westhaven |
| | Tata-Steel | Beverwijk |
| | ECT Venlo | Blerick |
| | Vopak Vlissingen | Vlissingen Sloehaven |
| | RWG (Rotterdam World Gateway) | Maasvlakte West |
| | EECV (Europort CV) | Europoort |
| | PCTBV (Pernis Combi Terminal BV) | Pernis |

Marshalling yard

| |
|----------|
| Kijfhoek |
|----------|

Figure 16: Terminals and marshalling yards in the Netherlands

| Country | Terminal | Handover station |
|---------|--------------------------------|---------------------------|
| BE | Ant. Gateway DP World Terminal | Antwerpen Kallo |
| | Deurganck PSA | Antwerpen Kallo |
| | Shipit (under construction) | Antwerpen Kallo |
| | Main Hub | Antwerpen Main Hub |
| | Hupac Terminal Ant. | Antwerpen Noord |
| | Ant. ATO | Antwerpen Noord |
| | Ant. Cirkeldyck | Antwerpen Noord |
| | Ant. Zomerweg | Antwerpen Noord |
| | Combinant | Antwerpen Noord |
| | Delwaidedock Terminal | Antwerpen Noord |
| | Europa Terminal PSA | Antwerpen Noord |
| | Mexico Natie N.V. | Antwerpen Noord |
| | Noordzee Terminal PSA | Antwerpen Noord |
| | Euroterminal Genk Exploitatie | Genk Zuid / Genk Goederen |

| | |
|------------------------------------|---------------------------|
| Haven Genk | Genk Zuid / Genk Goederen |
| Gent container terminal | Gent Zeehaven |
| IPG Intermodal Platform Gent | Gent Zeehaven |
| Dry Port Muizen | Muizen |
| Liège Logistique Intermodal | Renory /Kinkempois |
| Renory /Kinkempois | Renory /Kinkempois |
| Trilogiport (under construction) | Renory /Kinkempois |
| APM Terminal | Zeebrugge Vorming |
| Container Handling Zeebrugge (CHZ) | Zeebrugge Vorming |
| P&O ferrymasters | Zeebrugge Vorming |
| 2XL | Zeebrugge Vorming |
| Zeebrugge International Port | Zeebrugge Vorming |

Marshalling yard

| |
|-----------------|
| Antwerpen Noord |
|-----------------|

Figure 17: Terminals and marshalling yards in Belgium

| Country | Terminal | Handover station |
|--------------------------------|---|--------------------------------|
| DE | DeCeTe | Duisburg-Ruhrort Hafen |
| | Megahub Duisburg | Duisburg-Ruhrort Hafen |
| | PKV | Duisburg-Ruhrort Hafen |
| | Rhein Ruhr Terminal | Gbf Duisburg Hafen |
| | Logport II Gateway West Terminal | Duisburg Hochfeld Süd |
| | Contargo DIT Duisburg Intermodal Terminal | Duisburg-Rheinhausen Logport I |
| | D3T Terminal | Duisburg-Rheinhausen Logport I |
| | Duisburg Kombiterminal | Duisburg-Rheinhausen Logport I |
| | Neuss Intermodal Terminal | Neuss Hessoror |
| | Neuss Trimodal | Neuss Hessoror |
| | Umschlag Container Terminal GmbH | Neuss Hessoror |
| | Köln Eifeltor Ubf (DUSS) | Köln-Eifeltor Gbf |
| | Köln Niehl Hafen CTS | Köln-Niehl Hafen (HGK) |
| | Frankenbach Terminal | Mainz-Bischofsheim Gbf |
| | Contargo Mannheim | Mannheim Rbf |
| | Mannheim Handelshafen (DUSS) | Mannheim Rbf |
| | Mannheim MCT | Mannheim Rbf |
| | Ludwigshafen KTL (BASF) | Ludwigshafen BASF |
| | Contargo Ludwigshafen | Ludwigshafen Gbf |
| | DP World Germersheim | Germersheim Bf |
| | Karlsruhe Ubf (DUSS) | Karlsruhe Gbf |
| Karlsruhe Contargo | Karlsruhe Hafen | |
| SA/SVG Südbaden RALpin (RoLa) | Freiburg Gbf | |
| Basel/Weil am Rhein Ubf (DUSS) | Basel Bad Rbf | |

Marshalling yard

| |
|--------------------|
| Köln-Kalk Nord Rbf |
| Gremberg Rbf |
| Mannheim Rbf |

Figure 18: Terminals and marshalling yards in Germany

| Country | Terminal | Handover station |
|---------|------------------------------|--------------------------|
| CH | Swissterminal Basel AG | Kleinhüningen |
| | Satram-Huiles SA | Kleinhüningen |
| | Rhenus Port Logistics AG | Kleinhüningen |
| | Contargo AG | Kleinhüningen |
| | Ultra-Brag AG | Kleinhüningen |
| | Rhytank AG | Birsfelden Hafen |
| | Varo Energy Tankstorage AG | Birsfelden Hafen |
| | Ultra Brag AG | Birsfelden Hafen |
| | Birs Terminal AG | Birsfelden Hafen |
| | Swissterminal Birsfelden AG | Birsfelden Hafen |
| | Landor AG | Birsfelden Hafen |
| | TAU Tanklager Auhafen AG | Birsfelden Hafen |
| | Basel CT | Basel SBB RB |
| | Swissterminal AG Frenkendorf | Frenkendorf-Füllingsdorf |
| | Hupac Terminal Aarau | Aarau |
| | Swissterminal AG Rekingen | Rekingen |
| | Hupac Terminal Chiasso | Chiasso Smistamento |

Marshalling yard

| |
|---------------------|
| Basel SBB RB |
| Zürich Limmattal |
| Chiasso Smistamento |

Figure 19: Terminals and marshalling yards in Switzerland

| Country | Terminal | Handover station |
|---------|--|-------------------------|
| IT | Crossrail DOMO (Terminal) | Domo II |
| | DBS Hangartner | Domo II |
| | HUPAC | Busto Arsizio |
| | Ambrogio Intermodal | Gallarate |
| | CIM Interporto di Novara | Novara Boschetto |
| | Hupac (Ro-La) | Novara Boschetto |
| | Eurogateway | Novara Boschetto |
| | Terminal Intermodale di Mortara (TIMO) | Mortara |
| | Terminalitalia Intermodal Milano Certosa | Milano Certosa |
| | Terminalitalia Intermodal Milano-Smistamento | Milano Smistamento |
| | Sogemar | Melzo |
| | Terminal Intermodal Milano Segrate | Milano Smistamento |
| | Piacenza Intermodale | Piacenza |
| | Voltri Terminal EU | Genova Voltri Mare |
| | Terminal Ignazio Messina | Genova Marittima Bacino |
| | Terminal SECH | San Benigno - Bettolo |
| | ILVA Steel Factory | Genova Sestri Ponente |

Marshalling yards

| |
|-------------------------|
| Milano Smistamento |
| Alessandria Smistamento |
| Genova Sampierdarena |

Figure 20: Terminals and marshalling yards in Italy

Terminal information is also published in the Corridor Information Document (book 3, terminal description) respectively in the customer information platform (map). Both can be found via the Corridor Web Site www.corridor1.eu.

In the map characteristics of the terminals are presented in standardised templates under the icon of each participating terminal. The templates differentiate the type of terminal (intermodal, bulk, general cargo, see example Figure 21) and are provided by the terminals.

Characteristics and conditions of accessing corridor terminals

Characteristics of CONTAINER TERMINAL

General information

| | |
|------------------------|---|
| Owner property | (Name of the company) |
| Terminal operator | (abc GmbH) |
| Contact | (xyz@abc.com) |
| Address | (road, city and country) |
| Geographic coordinates | (44.406883, 8.878388 can be determined via Google Maps) |

| | |
|--------------------------|--|
| Mode | (please select) |
| Modes served | <input type="checkbox"/> Road <input type="checkbox"/> Rail <input type="checkbox"/> Ship |
| Opening hours | (Mo to Fr from 9 to 24) |
| Reachability/Location | (railway line Basel - Mannheim; Highway A5; Road) (Next rail freight station; Name / location / distance) (Last mile operator rail; if relevant) |
| Handling of | (Container 20' – 45', swap bodies ...) |
| Customs office available | (please select) distance (-) km |
| Services/specials | (Dangerous/hazardous goods, reefer, IT-System for data exchange ...) |

Infrastructure Parameter

| | |
|------------------------------------|--|
| Handling capacity ¹ | (approx. 155.000 TEU p.a.) |
| Storage capacity ¹ | (approx. 420 TEU p.a.) |
| Portal cranes (number/load in t) | (3 with 41 t load) |
| Reach-Stackers | (1x 41 t / 15 handlings per hour) |
| Other technical systems | (brake test systems, track scales ...) |
| Rail tracks (number/usable length) | (1x 240m) |
| Rail equipment | (Brake test system ...) |
| Electrification | (Yes/no, one/two-sided, next electrified yard) |
| IT infrastructure | (Modern terminal operation system covering all terminal functions, EDI interfaces possible/not possible) |

Development/Special Features

(good position in the near of the border between D/CH/F), other interesting facts ...)

(Today situation (volume per year) and prognosis for 20xx)

(Logistical platform for...)

¹ Capacities may vary according to the mode of operation, traffic/transshipment volume, wagon length and types of loading units; further advice is required to determine operational feasibility

All information is given by the respective terminal operator.

Figure 21: Example of terminal template

3 Transport Market Study

The following chapter is an excerpt of the Transport Market Study carried out from May 2012 until December 2012 showing essential elements in accordance to EU Regulation 913/2010. The information in this implementation plan is partly based on the results of the Transport Market Study but not necessarily identical.

3.1 TMS – Preamble

According to Art.9 para 3 of Regulation (EU) 913/2010 concerning a European rail network for competitive freight, the Rail Freight Corridor “Zeebrugge-Antwerp/Rotterdam-Duisburg-Basel-Milan-Genoa” (Rail Freight Corridor 1) has to carry out a Transport Market Study (TMS).

This TMS consists of three parts:

- A short-term part considering the current situation and the period up to 2016;
- A long-term outlook with a perspective up to 2020/2025;
- First proposals for routing and terminals (including marshalling yards).

The short-term and long-term parts of the Transport Market Study (TMS) for Rail Freight Corridor 1 cannot directly be compared. This is due to differences in the methodology applied and the scope of work, which are a consequence of the different objectives of both parts. The short-term part assesses the quantitative and qualitative evolution of the corridor-related rail freight market and the respective effects on the demand for international train paths based on the foreseen macro-economic and micro-economic development until 2016. The long-term part focuses on the identification of capacity requirements for rail freight related infrastructure on the Corridor until 2025 as a basis for an infrastructure bottleneck analysis. Despite their different aims and time horizons, the key results of both studies with regard to the evolution of demand for rail freight services on the Corridor are consistent with each other.

3.2 Short-term Study

(1) The **general scope** of the short-term TMS is the international freight transport market on Rail Freight Corridor 1. The study’s forecast horizon is 2016.

The short-term TMS has two **general aims**: The first is to enable the infrastructure managers (IMs) and Allocation Bodies (AB) along the Corridor to offer pre-arranged train paths (PaP) in accordance with market needs. This includes providing the necessary information to determine the routing, terminals, and amount of PaP. The second aim is to enable the IMs/ABs to implement measures to increase the competitiveness of rail freight.

To achieve these aims the following **key tasks** have been defined:

- Analysis and evaluation of the current situation of the international freight transport market and, in particular, of rail freight services on the Corridor regarding the size and structure of transport volumes, the modal split and the competitive situation.
- Elaboration of a forecast on the evolution of the demand for international rail freight services on the Corridor by the year 2016.
- Assessment of the market needs for pre-constructed path products¹.

¹ By „pre-constructed path products” the general term for both, international through-going catalogue paths (ITCP) and pre-arranged paths (PaP) are meant

- Highlighting the key success factors for corridor-related rail freight services based on a SWOT analysis of the existing and future rail freight transport.

(2) For carrying out the short-term TMS a **general methodology** has been designed in order to analyse both the current state and the evolution of the freight transport market on the Corridor from two different angles. Thus delivering a comprehensive picture of the market; it combines a macro-economic and a micro-economic approach.

The **macro-economic approach** uses formalised tools. They mainly include the analysis of statistical sources and a forecasting exercise based on the TRANS-TOOLS transport model. The key component of the **micro-economic approach** is a survey among a representative sample of almost 50 key stakeholders involved in the freight transport on the Corridor. The interviews have assessed the experts' existing business and their expectations on the future development and the competitiveness of rail freight services on the Corridor. In a bottom-up approach the findings have been cross-checked, verified and transferred into a market-based forecast of the volumes of corridor-related rail freight transport by 2016.

The results of both approaches have been compared, evaluated and transformed into final conclusions on the most likely development of rail freight services on Rail Freight Corridor 1 in the period up to 2016.

(3) Prior to the actual execution of the TMS, the **definition of Rail Freight Corridor 1** has been specified, since the Regulation only provides a rough indication. Based on the NUTS 2 classification system, 33 zones in the Netherlands, Belgium, Germany, France, Switzerland and Italy were allocated to the Corridor.

Then, the corridor-related transport flows, which are the subject of the short-term TMS, have been determined. A clear focus is set on international trade lanes connecting origins and destinations in these zones and crossing at least one corridor-relevant border (corridor-related trains). Trains entering/exiting the Corridor are analysed separately, but not in detail (additional trains)². Other trains such as passenger trains, national freight trains, purely operational trains between two border stations and trains entering/exiting the Basel border to/from France (trains on Rail Freight Corridor 2) have only been counted in total and in relation to the corridor-related trains.

(4) The analysis of the current situation is to describe the size and structure of the entire international freight transport market on the Corridor and more specifically the rail freight market, the modal split, the modal choice criteria and the competitive situation of rail freight transport. The work consists of three steps:

- Analysis of statistical data for the reference year 2010 by applying the TRANS-TOOLS transport model.
- Analysis of data on the actual freight train operations in 2010.
- Analysis of the terms of competition between rail and other corridor-relevant modes of transport, based on the survey among key stakeholders.

(5) The **analysis of official transport statistics for the year 2010** has taken into account the modes of land transport on the Corridor, which are road, rail and inland waterways. Based on the above corridor definition, a total international corridor related freight transport volume of about 232 million tonnes has

² Trains with origin and destination on the Corridor, but crossing the Belgian-Dutch border (not corridor-relevant border) are counted as additional trains.

been identified. A detailed investigation has delivered the following main findings on the structure of the transport market:

- The countries that are most affected by cross-border freight traffic on the Corridor are Germany with 84.5% of the total volume (196 million tonnes), the Netherlands with 61.6% (143 million tonnes) and Belgium with 24.6% (57 million tonnes).
- The largest single axis, accounting for an aggregated export and import volume of some 129 million tonnes, is between the Netherlands and Germany. The largest single trade lane is also on this axis: 47 million tonnes of goods were transported between the NUTS 2 zones of Rotterdam and Düsseldorf, mainly ores and metal waste (NSTR 4) and coal products (NSTR 2).
- In 2010, the most important commodity group transported on the Corridor was NSTR 9 (machinery, transport equipment, manufactured articles) with a volume of 44 million tonnes. Yet, the overwhelming majority of the international corridor-related volume of 154 million tonnes is accounted for by bulk goods such as minerals, building materials (NSTR 6), chemicals (NSTR 8), coal (NSTR 2), petroleum products (NSTR 3), ores and metal waste (NSTR 4).
- The analysis of the modal split shows, that in 2010, rail only held a market share of 14%. 54% of the total international freight volume was transported by barge and 32% by road. The small share of rail freight services must be considered against the background of a market featuring overwhelmingly short- and medium-distance transports of bulk goods on trade lanes along the Rhine valley. Here particularly barge has a competitive edge (see (7) and (9)).

(6) International rail freight services on Rail Freight Corridor 1 accounted for a total of about 32 million tonnes in the year 2010. The market structure can be characterised as follows:

- Rail achieves the largest volumes tonnages on trade lanes from/to with Northern Italy. The volumes from/to the Belgian and Dutch seaports totalled 19.9 million tonnes and from/to the Rhine-Ruhr area 31.1 million tonnes. The largest single flow was recorded on the Rotterdam-Düsseldorf link with 2 million tonnes.
- On virtually every trade lane where fierce competition reigns from inland waterways, the market share of rail freight services lies below average.
- However, rail freight transport, shows more than proportionate market shares, especially on routes, where competition of inland waterways is lacking, such as on transalpine trade lanes. So rail freight reaches top values of more than 70% on links between Belgium/the Netherlands and Italy.
- All country-country links, where rail reaches high or predominant market shares, represent only small volumes compared to the total freight market under consideration.
- It should be noted, that the commodity group with the highest volume tonnage in international rail freight on the Corridor is not a “typical” bulk product, but NSTR 9 (machinery, transport equipment, manufactured articles and miscellaneous articles). The latter contributed 19% to the total volume in 2010. Petroleum products, chemicals and coal accounted for about 14%, 10% and 10% of the total, respectively.
- Rail has no leading market position in any commodity group. It reaches its highest market share of about 21% for NSTR 9. For NSTR 5 (metal products), NSTR 2 (solid mineral fuels) and NSTR 3 (petroleum products) it reaches market shares of 19%, 18% and 17% respectively. Inland waterway transport is dominating NSTR 2, NSTR 3, NSTR 4 (ores and metal waste), NSTR 5, NSTR 6

(crude and manufactures minerals, building materials) and NSTR 7 (fertilisers). Road transport is market leader in the commodity groups NSTR 0 (agricultural products and live animals), NSTR 1 (foodstuffs and animal fodder), NSTR 8 (chemicals) and NSTR 9.

(7) In addition to official statistics, data sets on **actual freight train operations**, supplied by the infrastructure managers belonging to the Corridor, have been examined. It has been decided to use data of two representative weeks (week 7 and 30) in the year 2010. The analysis has provided the following key results:

- On average, 1,484 international freight trains per week are operated with origin and destination on the Corridor and crossing at least one corridor-relevant border (corridor-related trains), corresponding to about 270 trains daily. Trains entering/exiting the corridor and crossing at least one corridor-relevant border (additional trains) amount to 843 trains per week (thus additional 57% to the 1,484 trains). Trains with origin and destination on the Corridor, but crossing the Belgian-Dutch border (not corridor-relevant border) are counted as additional trains.
- Of the 1,484 corridor-related trains, the axis the Netherlands-Germany accounts for 25% of all trains, Germany-Italy for 20%, Belgium-Germany for 17%, and Germany-Switzerland for 13%. 96% of all international freight trains are operated via the German network and 58% through the Swiss network.
- With an average of 827 weekly trains, intermodal services clearly dominate international rail freight transport on the Corridor in the reference year. Their share of the total rail freight market amounts to 56%. 354 trains or 24% account for single wagon traffic and 303 runs (20%) for block trains in “conventional” wagonload traffic.
- Just 17% (248 trains per week) of all international freight operations require a train path along the entire length of the Corridor involving four countries between Belgium or the Netherlands and Italy. Every single one of them is destined for an intermodal service. Nearly 25% (364 trains) of the total number operate over the network of three countries, 85% of which are intermodal services. A majority of 59% of all freight trains are limited to two neighbouring countries. These bilateral transport segments are dominated by wagonload services with a share of 68%.
- About 80% of all international freight trains on the Corridor are operated on regular train paths, applied for in the framework of the annual scheduling process by –at the latest- the deadline of X-8, that is eight months prior to the timetable change in December. The share of trains operating on ad-hoc paths on the Corridor is, with 20%, remarkably small.
- The share of corridor-related international freight trains in relation to the total volume of trains on the Corridor (including passenger and national freight trains) varies between Switzerland (about 4.8%), Belgium (4.5%), the Netherlands (3.6%) and Germany (2.7%). These results can be explained on the one hand by a different general market relevance of rail freight and by the length of the corridor sections and their general importance in the respective national and European network on the other hand. The German section of the Corridor has a length of about 600-630 km, compared to about 170 km in Belgium and some 160 km in the Netherlands. In Germany, the corridor lines are frequently used by numerous national and international freight services and characterised by a high density of national passenger services along the cities in the Rhine valley.

(8) The investigation into the current situation has been concluded with an **evaluation of the key modal choice criteria and the competitive situation** for each of the main types of rail freight services. The

findings are based on the survey among stakeholders, complemented by the market knowledge of the consultancy team.

Wagonload traffic is dominated by the movement of bulk commodities such as iron ore, coal, steel, agricultural products and chemicals. The key factor of modal choice is clearly the cost of transport. All other service level requirements such as reliability, flexibility or tracking and tracing should be taken seriously by rail service providers, but seem to remain secondary in comparison to cost. The survey has identified three distinctive markets:

- The largest segment is the “Rhine valley market” with origin and destination of the goods having a direct barge access. Shippers prefer barge since the unit cost per tonne transported lies up to 50% lower than rail freight, even in case of wagonload block trains. Despite this, about 10 to 30% of the entire volume is contracted to rail in order to prevent a monopolistic position of barge operators and to provide for a back-up solution in case of disruptions in inland navigation.
- The “off-Rhine valley market” relates to trade lanes where either the origin or the destination or both are not ideally located near the Rhine. Here the competitive situation is opposite to the one on the “Rhine valley market”. The use of barges has a strategic function, but rail services are more cost-efficient and particularly when full train loads are available. In case of less-than-trainload volumes, road can also offer competitive freight rates and thus has gained a high market share, for example, in the transport of bulk chemicals.
- The “transalpine market” comprises trade lanes from/to Northern Italy and Central and South Switzerland. In case of sufficient volumes and the availability of rail sidings, block trains can offer the lowest cost. In other cases, road usually is preferred over single wagon traffic.

Companies forwarding or receiving general cargo, such as finished and semi-finished products, usually do not provide for regular full train-load volumes. Therefore, if the goods are shipped by rail, they would have to be carried generally on single wagonload services. In most cases, their service level can neither match the performance of road transport nor meet shippers’ requirements regarding the key modal choice criteria transit time, transport cost and reliability. Due to this crucial weakness, the market share of wagonload services of general cargo is very small. Those commodities are either carried by road or intermodal services.

Maritime intermodal transport is the movement of marine containers between seaports and their hinterland. The most important seaports on the Corridor for international intermodal services are - by order of rail-based volume - the ports of Rotterdam, Antwerpen and Zeebrugge. The competitive situation on trade lanes with inland locations is as follows:

- In general, the cost of a port-to-door transport is decisive for the modal choice.
- Barges clearly set the cost benchmark. Providing for a load capacity up to 800 TEU as opposed to 80 to 100 TEU for intermodal trains, barge is the most cost-efficient on trade lanes with inland ports in the Rhine valley.
- Rail can compete with barge and road in the area of Ludwigshafen/Mannheim and gain a leading position on destinations within the upper Rhine and Switzerland.
- On trade lanes with the Rhine-Ruhr area, existing rail services are not competitive but have a strategic function for certain stakeholders as a component of their overall container hinterland policy.
- Trucks are competitive on distances up to 250–300 km from the North Sea ports since they achieve efficient round trips in a single driver shift. But they have also captured high market shares on routes over 450 km or more, due to fast transit times and flexibility.

- A high percentage of import containers is getting urgent for various reasons. Only road operators are flexible enough to supply transport capacities on short notice and ensure a fast and on-time delivery. Here costs are not crucial anymore and freight rates are high.
- If rail is capable of offering transit times comparable to road, in cases where speed matters, it can outclass road due to its lower unit costs.

The catchment area of the North Sea ports generally ends in Switzerland. The volume of marine containers shipped from and to Italy is small. International container transport from/to Genoa or other Italian seaports are of marginal importance. Apart from sporadic flows from/to Switzerland, the catchment area is supposed to be limited to domestic routes.

Continental intermodal transport is the movement of goods, which are sourced in and bound for a location within Europe. The majority of the current volume is carried on transalpine trade lanes between Northern Italy, on the one side, and Belgium, the Netherlands and Germany, on the other. The scope of continental services on non-transalpine routes in the northern section of the Corridor is limited. Customers of continental intermodal services are virtually only forwarders delivering door-to-door logistics for shippers. Their key modal choice criteria are transport cost, transit times and reliability. The weight of each factor depends on the category of goods and the required logistics service level. The existing competitive situation on Rail Freight Corridor 1 can be characterised as follows:

- The majority of intermodal services are geared to shipments, which require a cost-efficient but not time-critical transport and which do not necessarily have to match the high reliability standards of trucks, such as full-truckloads and commodities moved “in bulk”.
- Intermodal rail services are particularly competitive on transalpine routes due to efficient rail production systems such as shuttle trains.
- Additionally, intermodal rail transport benefits from a Swiss transport policy, which regulates road transport and promotes intermodal services.
- Chemical products are a key factor to continental services due to the huge market based on the clusters of the chemical industry. They often only need a basic train capacity which facilitates the start up of a new service.
- Consumer goods are increasingly transported, in particular on the Lötschberg corridor, since it allows moving 4m high semi-trailers, the standard equipment in this market segment.
- While continental intermodal services are competitive on transalpine trade lanes through Switzerland, only a few services in the triangle of Belgium, the Netherlands and Germany can compete with road in terms of cost and reliability.

(9) The second part of the short-term TMS has analysed the **evolution of the demand for international rail freight services on the Corridor by 2016** and addressed, in particular, the following aspects:

- Forecast of the development of the size and structure of international rail freight transport in the period up to 2016 based on existent traffic.
- Identification of new business opportunities.

- Requirements of stakeholders towards train path planning particularly with respect to the demand for international through-going catalogue paths (ITCP), which are an early version of pre-constructed path products³.

As the analysis of the existing situation, the forecasting exercise has been carried out both with a macro- and a micro-economic approach. An important component of both forecasting exercises has been the analysis of the impact of political, economic, social, technological and logistic factors (PESTL) on the future demand for rail freight services on the Corridor. Those factors assumed to have both a noticeable impact on rail freight demand and a high or very high occurrence probability in the period up to 2016, have been taken into account and were integrated in the forecasting exercises.

(10) The macro-economic approach is essentially a **model-based prognosis of international rail freight volumes** on the Corridor by 2016. It includes the following:

- The main factors influencing the evolution of transport demand are socio-economic performance indicators. As the present TMS covered a comparatively short-term forecasting period it has been decided that factors that belong to structural changes in the long term can be neglected.
- As a consequence, economic parameters are the most important input for the prognosis. Since the economic situation in Europe, in general, and in the countries involved in the Corridor, in particular, has been rather volatile since the global slump in 2008, and the vulnerability of some economies to financial and economic disruptions have not significantly decreased, the consultancy team has been challenged to identify the potential path of development of the countries affected. In order to get a broad picture of assessments, reports from different sources - public administrations as well as private think tanks - have been analysed and evaluated, and the most likely evolution of leading economic indicators for each country determined.
- The demand for international freight services on the Corridor ultimately depends on the evolution of the external trade between the countries involved and the transport intensity of the underlying goods. Therefore, the critical factors having an impact on the evolution of the export and import volume have been identified for every NSTR commodity group.
- Based on this input a well-established transport model can be applied. It delivers total and mode-specific international freight transport volumes till 2016 for every origin /destination of the 33 NUTS 2 zones on Rail Freight Corridor 1.
- The transport model also includes modelling parameters allowing predicting the evolution of the individual types of rail freight services.

The key results of the model-based prognosis are as follows:

- The total international rail freight volume on the Corridor will rise from 33 million tonnes by approximately 2.8 million tonnes in the period from 2010 to 2016. This means a growth of 8.5% which corresponds to an average linear increase of 1.4% per year.
- The commodity group NSTR 9 is estimated to account for almost 40% of this growth. A substantial increase of corridor-related volumes is also expected for chemicals, minerals/building materials, agricultural products and coal.

³ By „pre-constructed path products“ the general term for both, ITCP and PaP is meant (for more details, see below (13) and Glossary).

- In 2016, 1,586 international freight trains per week are predicted to run on the Corridor, a plus of 102 trains (+6.8%) compared to 2010. This means an average linear growth of 1.1% per year.
- More than 70% of the additional train runs will be account for by intermodal services, raising their total number by 73 trains from 827 (2010) to 900 weekly trains (+9%) in 2016. Single wagon traffic (+15 weekly trains) and wagonload block trains (+13 weekly trains) are expected to increase by about 4%.

(11) The micro-economic approach consists of a **market-based prognosis of international rail freight volumes** by 2016, resulting from a survey among key stakeholders involved in freight transport on the Corridor. It includes the following:

- The stakeholders have been asked to assess the evolution of their existent business with regard to the use of rail freight services. The statements have been examined, taking into account the main impact factors and drivers of anticipated trends. The results of the interviews have been analysed separately per main business sector involved: railway undertakings, shippers and logistics service providers.
- Based on these findings, the consultancy team has developed a consolidated forecast of the evolution of the corridor-related demand for international rail freight transport by 2016, based on existing business. Individual prognoses have been elaborated for every type of rail freight service. This work includes a thorough evaluation of the stakeholders' statements with respect to their plausibility and validity. The forecasting results have also been put in the context of the previous evolution of rail freight transport volumes on the Corridor by examining historical statistical data. This exercise proves that the forecasted developments are far from being ambitious or exceptional, but rather conservative.
- The survey has also identified significant new business opportunities and additional market potential for international rail freight services. They relate to the sectors coal, chemicals and steel. All volumes have a strong affinity to wagonload traffic and would be suitable to be conveyed on block trains.
- The results of both steps have been merged and translated into a consolidated market-based forecast of rail freight transport by 2016.

The key results of the market-based prognosis for Rail Freight Corridor 1 are as follows:

- The total international wagonload traffic is expected to rise by an average linear growth rate of about 1.5% per year over the period 2010 to 2016. Most manufacturing industries will keep their demand at the current level or grow or reduce it at marginal rates. A noticeable growth is expected for chemicals, the railport system and for steel products.
- The growth of wagonload traffic shall only be accounted for by block trains, since single wagon traffic on the Corridor is expected to decline by an average linear rate of about 0.5 % per year.
- As a result, the number of international wagonload block trains is forecasted to increase by 11% between 2010 and 2016 to 336 weekly trains (+1.8% p.a). The market share is to rise to 19%. Single wagon traffic, on the contrary, is expected to decline by 3% to 345 weekly trains.
- The expectations for maritime intermodal transport on the Corridor are significantly more optimistic. The stakeholders expect an average linear growth rate of about 7% per year over the period under consideration. Rail-based container hinterland services from/to the port of

Rotterdam are predicted to increase more than proportionately, whereas Antwerpen and Zeebrugge will follow a slower path of growth.

- The experts are somewhat less optimistic regarding continental intermodal transport. The volume is estimated to rise, on average, by an annual linear growth rate of 4% in the period up to 2016.
- The segment-specific assessments are aggregated into a forecast of the evolution of the total intermodal transport on the Corridor. According to this, the number of intermodal trains is expected to soar by 29% and rise to 1,066 train runs in 2016 (+4.8% p.a.), which corresponds to an annual linear growth rate of nearly 5%. As a result, the market share of intermodal trains will improve by 5 percentage-points to 61%.
- The total number of international freight trains on Rail Freight Corridor 1 would increase by 17.7% from 1,484 weekly trains in 2010 to 1,747 weekly trains in 2016. This corresponds to an average linear growth rate of approximately 3% per year over this period.

(12) The **model- and market-based forecasting exercises** show two major differences. Firstly, the market-based prognosis results in a significantly stronger growth than the model-based forecast. Secondly, the latter forecasts a 4% plus of single wagon traffic between 2010 and 2016, while the market-based prognosis expects a decline of this segment. The differences are due to the following key impact factors:

- The model-based forecast is a kind of trend extrapolation. The market-based prognosis has additionally taken into account the modal shift expectations of the stakeholders involved in the survey.
- The transport model cannot recognise new business opportunities for rail revealed in the survey.
- The survey clearly shows, that even in a short-term perspective, a huge majority of logistics experts expects a further decline of single wagon traffic. This noticeable trend is not reflected in the parameters of the transport model.

Against this background, the two forecasting exercises may be considered as delivering a range of the potential evolution of demand for international rail freight transport on Rail Freight Corridor 1, with the model-based results as the “bottom line” and the market-based forecast as the “top line”.

(13) One of the key subjects of the short-term TMS is the analysis of the requirements as expressed by market actors on **train path planning and management** and if and to what extent they would be interested in applying for international through-going catalogue paths (ITCP). Pre-constructed path products can be defined in several ways depending on their product features:

- For the TMS, the concept of international through-going catalogue paths (ITCP) has been used as this is the one that has been valid and known to the relevant players in 2012 (as offered for the timetable 2013). A main feature of these paths is that they are constructed for the complete corridor from one end to the other.
- In January 2013, the “Working Group PaP” of the Corridor has worked out an enhanced definition of pre-constructed path products taking into account market needs. Based on this definition, pre-constructed path products will be an assembly of sections of the Corridor, so that the offer can be either a path along the whole corridor or only on sections of the Corridor, as long as one or more corridor-relevant borders are crossed. These paths will be the pre-arranged paths on the Corridor according to Regulation (EU) No 913/2010 (PaP).

In a first step, the existing offer of ITCP has been analysed for the timetable 2013. The analysis shows that apart from the 168 weekly ITCP offered in Italy, which has all been applied for, the demand for ITCP has met between 0% and 41% of the supply.

In a second stage, the stakeholders, interviewed in the frame of the market survey, have been asked to provide their assessment of and interest in ITCP. The results are as follows:

- Most shippers and logistics service providers are not familiar with ITCP and consider them only relevant for railways.
- The majority of the railway undertakings interviewed, including the key players - representing about 80% of the current rail freight volume on the Corridor - shows little interest in ITCP. However, some railway undertakings having smaller market shares on the Corridor tend to see more benefits than disadvantages in the ITCP concept.
- The majority of railways and intermodal operators considers ITCP raising more problems than solving them for the following reasons: According to them, ITCP block capacity on rail sections and impede an efficient train path for long-distance services; they reduce the flexibility for customised train path planning and decrease the overall network capacity; their pre-determined stops for change of locomotives and/or drivers may not match individual operational schemes of railways.
- The main benefit of ITCP, an accelerated train path allocation, is shared by virtually all actors. On top of that, it is pointed out that ITCP may ensure that rail capacity is blocked for freight services and can be used if needed.

The key message that the stakeholders wished to convey, is that ITCP generally should not be constructed for the entire corridor. ITCP are regarded reasonable for “closed systems” or sections like the Betuwe line or Swiss transit routes but not for the entire Rail Freight Corridor 1, providing multiple links with other corridors. In order to guarantee flexibility and an efficient utilization of capacity, ITCP should be designed taking into account appropriate segments.

An important aspect of the update of the TMS will be, to analyse to what extent the offer of PaP will meet the needs of the international rail freight market on Rail Freight Corridor 1 in the next years.

(14) In a final step, the results of the current and expected future competitive situation for international rail freight services on Rail Freight Corridor 1, which had been deducted particularly from the survey among stakeholders, has been consolidated and processed in the form of a **SWOT analysis**. It displays the major strengths and weaknesses of existing rail freight services on the Corridor and highlights the opportunities, which may emerge in the period up to 2016, and also some major threats, which may jeopardise current services or hinder the growth of rail freight volumes.

Based on these results and the expertise of the consultancy team the **key success factors** for rail freight services on the Corridor have been identified. **Improvement actions** have been suggested, which -if implemented by the stakeholders of the rail freight industry on the Corridor - would lead to rail freight volumes even higher than forecasted. The main actions for corridor-related rail freight services in the period up to 2016 are as follows:

- Transport cost plays a crucial role in the competition with road and barge. Therefore, it is of paramount importance that rail freight services become more efficient in the coming years.
- It is equally important to raise the service level and the performance both for wagonload and intermodal services. In this respect a road-competitive reliability has top priority and ranks higher than faster lead times.

- The reliability improvement of services would also have a major cost effect. The productive resources such as locomotives, wagons, terminal handling facilities and personnel could be more efficiently employed and thus reduce the unit cost of rail freight services.
- An increase of the frequency of service on high-volume trade lanes can improve the competitiveness, particularly of maritime and continental intermodal services. Such industrialized production schemes can also contribute to increased cost-efficiency of intermodal services on medium transport distances, for example, between the North Sea ports and the Rhine-Ruhr area.
- The harmonisation of train parameters (length, weight, speed) throughout the Corridor would contribute to a more efficient use of standardised train sets and train paths.
- The intermodal terminal infrastructure in the hinterland of the North Sea ports should be enlarged regarding handling and storage capacity in order to accommodate for the predicted growth of rail-based maritime intermodal services.

The composition of the road vehicle fleet has substantially changed over the past 20 years. Semi-trailers now dominate international road transport. Many forwarders using craneable semi-trailers are keen to shift volumes to continental intermodal services. In order to catch a greater share of this market the current shortage of pocket wagons should be eliminated through additional investments.

3.3 Long-term Study

(1) The time horizon for the forecast in the long-term Transport Market Study (TMS) is 2025 whereas the short-term prognosis covers the period up to 2016. The objective of the long-term study, which was carried out by the infrastructure managers belonging to Rail Freight Corridor 1, is to identify the long-term capacity requirements for rail freight services on the corridor-related rail network. The results are due to enter into an infrastructure bottleneck analysis at a later stage.

(2) The basic **methodological approach** of the prognosis on the long-term demand for freight trains on the Corridor differs fundamentally from the short-term forecasting exercise:

- The long-term forecast is built on separate national studies at country level and the national infrastructure managers involved in the Corridor. The individual results are then merged to a corridor-wide assessment.
- The short-term TMS is designed to investigate only international freight transport on trade lanes whose origin and destination are or will be on the Corridor defined by 33 geographical zones according to the NUTS 2 classification system. The long-term TMS, additionally, takes into account the corridor-related domestic trains as well as international trains, which – by the prognosis horizon in question - would use sections of the Corridor but whose origin or destination or both would not be on the Corridor. Such an approach is consistent with respect to the underlying objective of this study, which is to analyse the overall capacity need for freight trains on every section of the Corridor.

(3) The **structure of the long-term TMS** results from the above objective and the methodology selected and comprises three parts:

- The first part explains the national forecasting methodology of the countries involved in the Corridor.
- The second part specifies the most important infrastructure investments planned on the Corridor over the period up to 2025.

- The final part presents the forecasting results regarding the volume of freight trains on defined sections of the Corridor expected by the time horizons 2020 and 2025, respectively.

(4) The characteristics of the **national forecasting methodology** are as follows:

- **The Netherlands:** Based on previous studies infrastructure manager ProRail and TNO have elaborated various scenarios. The TRANS-TOOLS model 2 is applied to forecast the future demand for transport volumes. Depending on the scenario it ranges between 49 and 87 million tonnes in 2020 and between 54 and 112 million tonnes in 2030.
- **Belgium:** The long-term forecast of infrastructure manager Infrabel was prepared by Roland Berger in 2009. It includes four scenarios that are differentiated by assumptions such as GDP growth expectations and the impact or the lack of impact of structural changes in manufacturing industries. The prognoses cover the period from 2008 to 2030. The “slow growth” scenario forecasts an increase of rail freight tonnage of 52%, the “freight competitiveness” scenario of 129% and the “sustainable growth” scenario of 182% over the given period of time.
- **Germany:** The infrastructure manager DB Netz uses the forecast of the German Federal Transport Infrastructure Plan commissioned by the Federal Ministry for Transport, Building, and Urban Development. Based on a 2004 data set the demand for all modes of freight transport is forecasted for the year 2025. According to this prognosis the transport performance of rail freight would increase by an average annual rate of 2.4%, while road should achieve a 2.8% growth rate. Against this trend, intermodal transport is expected to raise its volume more than proportionately by, on average, 4% per year.
- **Switzerland:** The national forecasts on transport demand are prepared by the Department for Environment, Transport, Energy and Communication. The basic work was fulfilled with the 2004 study “Prospects of Swiss freight transport by 2030”. It includes a base scenario, which essentially is a trend extrapolation, and two alternative scenarios with either a more positive or negative impact for rail. A 2008 update of the study integrating more recent actual data just maintained the base scenario. According to this prognosis the volume of rail freight transport in Switzerland is expected to double from about 50 to 100 million tonnes over the period 1998 to 2030.
- **Italy:** The prognosis for rail freight transport is developed in the Working Group 1 (Infrastructure Monitoring) and validated by the Management Committee Italy-Switzerland, composed of representatives from the Italian Ministry for Infrastructure and Transport, the Swiss UVEK and the IMs of these countries.

(5) The long-term TMS contains a comprehensive list of infrastructure investments planned by the infrastructure managers over the period up to 2025. An overview of the most important measures is presented in the following Figure. These investment projects will be gradually put into service over the years. Yet, for the purpose of the TMS the IMs have chosen the time horizons 2020 and 2025 to present the expected rail infrastructure improvements in question. It is emphasised that the impact of these investments in respect to an increased attractiveness of rail freight services are taken into account in the long-term transport prognoses.

(6) The IMs have translated the country-related forecasts on the evolution of rail freight transport volumes into **freight trains affecting Rail Freight Corridor 1** or sections of the Corridor by the time horizons 2020 and 2025. As mentioned above the following results include “corridor trains” as defined

for the short-term TMS as well as domestic and other international trains supposed to use sections of the Corridor in the course of their entire journey:

- In the period 2015 to 2020 the number of freight trains is estimated to increase on nearly all sections of the corridor-related rail network. In most cases the growth rates range between 3% and 30%, while the volume of freight trains is expected to soar on the Betuwe line. There are just a few sections, where freight train journeys will remain stable or decrease slightly, which is likely to be connected with an infrastructure improvement and a steep growth of the freight train volume on a parallel railway line.
- The results are very similar for the period 2020 to 2025. Apart from a few sections, the entire corridor is expected to see a further increase of freight train journeys between 3% and 30%. Stronger growth rates of more than 60% are forecasted for the link between Maasvlakte I and II.

3.4 Important Investments in Rail Freight Corridor 1 until 2025

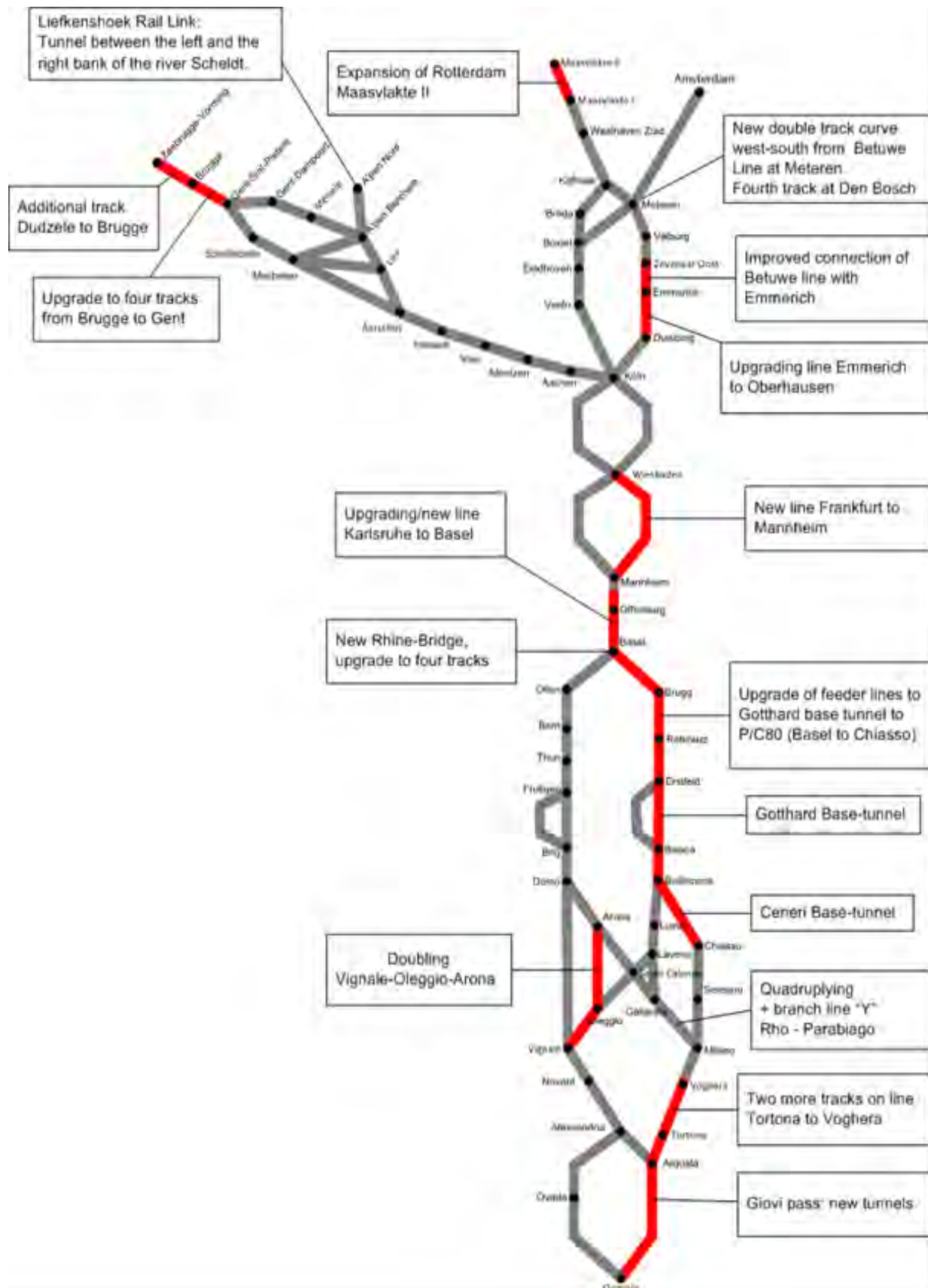

Figure 22: Important infrastructure investments until 2015, based on the preliminary routing of 2012

3.5 First Proposals on Routing and Terminals

On the basis of the results of the short-term and long-term parts of the TMS, first proposals for routing and terminals (including marshalling yards) have been worked out serving as a starting point for further decisions on the Corridor. Apart from the results of the TMS; other aspects relevant for defining corridor terminals and routing have also been taken into consideration. Due to their preliminary nature, the proposals are only made visible for decision makers within the Rail Freight Corridor 1 without prejudging a financial commitment of a Member State. The implementation depends on the availability of financial resources.

4 Measures

4.1 Measures Related to the Regulation (EU) No 913/2010

According to Article 9 of Regulation (EU) No 913/2010 the implementation plan describes also measures for fulfilling requirements of Articles 12 to 19, comprising coordination of works, one-stop-shop, capacity allocation, authorised applicants, traffic management, traffic management in the event of disturbance, information on the conditions of use of the freight corridor and quality of service on the freight corridor.

4.1.1 Cross-border Coordination of Infrastructure Works

Until now major construction works and possessions on the Corridor have been coordinated between the IMs. Further on, they have been published on some of the homepages of IMs and on the RNE homepage. RUs have been informed accordingly by the IMs. This procedure shall be further improved by establishing a regular process for the early information and involvement of the RUs.

Based on Article 12 “Coordination of works” of the Regulation (EU) No 913/2010, RNE guidelines provide recommendations for the process of coordinating and publishing activities reducing the available capacity on a Rail Freight Corridor (RFC). Included is a description of a tool which is recommended to be used by IMs and corridor organisations for gathering and publishing information about capacity restrictions.

To achieve this, the coordination and communication process will be enhanced to involve applicants regularly up from 24 months in advance and publish the information for the entire corridor. The responsible representatives of the IMs are implementing the related procedures.

Because the information is needed for capacity planning and timetabling, all impacts of the possessions on the availability of the infrastructure are described (e.g. closure of the line, single line operations), as well as the impacts on rail traffic (e.g. expected delays, necessary re-routings, diversionary routes) and the duration of the restrictions (e.g. period, all day, specific dates and times). Technical and financial details are not included. After initial publication of possessions further details may be added.

A working group “Coordination of Works” of RFC 1 has been set up and is coordinating the possessions and renewal works in a way that the capacity on the network can be kept as high as possible. A close contact with the railway undertakings will take place. Duration, character and impact of works will be published and regularly updated. The communication with the Corridor One-Stop-Shop will be given in order to establish correct path catalogues with pre-arranged paths. Coordination with other corridors will be made especially when similar transit lines are concerned.

The working group “Coordination of works” of RFC 1 liaise the works and possessions with the RUs in May and November for the years 2014, 2015 and 2016 (see Figure 23). Published lists of works will be updated regularly.

The detailed process descriptions can be found in the Customer Information Platform (CIP) under tab “Traffic & Performance Management/Coordination of Works” or in the Corridor Information Document, Book 4.

To have an overview of all planned capacity restrictions, which is easily available to all involved parties, the common templates and the Customer Information Platform are used. The list of works and possessions can be found in the mentioned platform under the tab “Infrastructure”.

For more information about rail freight corridors’ procedures please see RNE Guidelines.

<http://www.rne.eu/downloads/items/rfc-guidelines-specifications.html>



Figure 23: Timeline and working structure for coordination of works

4.1.2 Corridor One-Stop-Shop (C-OSS)

Introduction

The EU Regulation 913/2010 concerning a European rail network for competitive freight aims at enhancing international rail freight by improving the conditions of the use of rail infrastructure. As one major measure Article 13 of the Regulation foresees the implementation of a so-called One-Stop Shop (OSS) for applicants to request and receive answers in a single place and a single operation regarding infrastructure capacity for freight trains crossing at least one border along the rail freight corridor.

To prepare the implementation of the C-OSS a special working group has been set up in 2012. The working group is composed out of OSS experts of the concerned IMs and AB and chaired by DB Netz. A detailed work plan has been elaborated in July 2012 and adopted by the Management Committee in September 2012. According to this work plan the following work packages were/are tackled:

WP 1: Internal rules and operational guidelines for C-OSS

The working group agreed on the C-OSS tasks and elaborated detailed process descriptions for four fields of activity:

- a. Pre-Sales of pre-arranged paths (PaP)
- b. Sales process for pre-arranged paths
- c. After Sales / Monitoring incl. Key Performance Indicators (KPIs)
- d. Pre-Sales and Sales of Reserve Capacity

Delivery:

Process descriptions completed in December 2012.

WP 2: Path Catalogue for PaPs

A user-friendly overview of the PaP catalogue can be found on the RFC 1 Web Site under "C-OSS" as well as in the Customer Information Platform, also in the tab "C-OSS".

In advance of the first PaP catalogue to be published by the C-OSS in January 2014 for timetable 2015 the working group is providing an international overview of catalogue paths for timetable 2014 in a new format (one page view). Delivery: New format of path catalogue published on RNE Homepage as well as on some IM Homepage in January 2014.

WP 3: Desktop and tools for C-OSS work

To support the C-OSS in his daily work some tools have been elaborated (e.g. contact lists etc.). Especially the IT Tool PCS has been adapted in close cooperation with RNE to become the exclusive booking tool for paths distributed and managed by the C-OSS. For PCS, a customer training has been foreseen and the first PaP-requests will be accepted from January 2014 onwards.

WP 4: Marketing / Communication

To promote the benefits of the C-OSS the working group committed on a communication plan which includes the publication of a C-OSS brochure, website incl. FAQ and customer information campaign.

Delivery:

C-OSS Brochure in June 2013; Go life of C-OSS Website and customer information letter in November 2013; welcome package and PaP catalogue in January 2014

The goal of the C-OSS

The C-OSS aims at facilitating and enhancing international rail freight by serving as a single point of contact for international path applications along Rail Freight Corridor 1.

Therefore, the C-OSS constitutes a new and exclusive service channel for managing specific international freight paths on the Corridor:

- pre-arranged paths (PaP) and
- reserve capacity (RC)

In addition, the C-OSS facilitates the elaboration of a harmonized and reliable corridor path offer (pre-sales) , provides all required basic information on the Corridor and ensures a transparent monitoring of the whole international corridor path management (after sales).

The offer of the C-OSS

On RFC 1, a dedicated expert group composed of specialists from the IMs and allocation body has defined the corridor principles regarding pre-arranged paths (PaP) and reserve capacity. PaPs on RFC 1 will be an assembly of several PaP sections (segments) and not just only an entire PaP from Rotterdam, Antwerpen or Zeebrugge to Genoa. PaPs are based on standard parameters for rail freight and previously coordinated between the IM/allocation body at the borders so to enable for attractive running times. The definition of the offer (quantity) is based on the results of the Transport Market Study and input from applicants as well as IMs own experiences with existing and previous traffic. For every timetable period, the Management Board of RFC 1 will decide on PaP and Reserve Capacity offers. A common understanding of the relevant characteristics of the PaPs and their planning and construction principles has been agreed and will be applied for the first time for the timetable 2015.

The C-OSS acts as an exclusive agent for international pre-arranged paths (PaP and RC) on the RFC 1.

International pre-arranged paths for the annual timetable are provided by the rail infrastructure managers/allocation body to the C-OSS. The path catalogue of PaP will be published by the C-OSS in mid-January of each year for the next timetable period and will be updated in May and August offering still available capacity.

Reserve capacity on the RFC 1 is available from October of each year to allow for ad-hoc path applications.

The offer of the C-OSS will be displayed for information on the RFC 1 Web Site under “C-OSS” <http://www.corridor1.eu/corridor-one-stop-shop.html>

and for booking in the IT-application PCS (Path Coordination System) provided by RailNetEurope (RNE) http://www.rne.eu/pcs_timetabling.html.

Path application and allocation of PaP and RC

Pre-arranged paths and reserve capacity on the Corridor are exclusively offered by the C-OSS.

Therefore, the path application is to be done via the IT-application Path Coordination System (PCS) directly and addressed to the C-OSS. In any case, the applications for PaP via PCS concern regular path applications for the annual timetable – so that applications which cannot be satisfied by the C-OSS will be forwarded to the concerned infrastructure managers/allocation body for further processing.

The application to the C-OSS shall refer to an international section of PaP or RC. The application may be enlarged by feeder/outflow paths and/or connecting paths/parts of other EU rail freight corridors. In this case (PaP plus) the C-OSS will arrange for a consistent timetable offer including PaP and feeders/connections in cooperation with the concerned national IM/allocation body.

The allocation decision on PaP will be taken by the C-OSS on basis of corridor-specific and internationally harmonized allocation rules, which are described in the Framework for Capacity Allocation of RFC 1.

The allocation decision on reserve capacity will be done by the C-OSS with regard to the date of the application (first come, first served).

The timetable offer provided by the C-OSS is given on behalf of the concerned national infrastructure managers/allocation body. In any case the infrastructure usage contracts will be concluded between the applicants and the concerned national infrastructure managers on the basis of the relevant individual national network access conditions.

The process descriptions and details are available on the Customer Information Platform under tab “C-OSS”.

The benefits for applicants

The C-OSS is able to bundle international path applications at one place as well as to ensure the execution of the allocation decision and the submission of the complete international timetable offer in one single operation.

Due to these C-OSS activities applicants may benefit from:

- One catalogue with early and reliable information on international freight paths
- One homogenous allocation decision for the whole international path
- One consistent international timetable offer out of one hand (incl. feeders/connections)
- Transparency on available reserve capacity on the Corridor

By these means, the C-OSS aims at supporting the customers in executing their annual transport planning as well as respecting the need for short term rail freight transports.

The organisation of the C-OSS

The infrastructure managers/allocation body along RFC 1 decided to mandate one infrastructure manager amongst them to operate the C-OSS in accordance of the representative C-OSS model of RNE. The designated infrastructure manager provides the staff/experts who are exclusively dedicated to the C-OSS.

4.1.3 Framework for Capacity Allocation

The Executive Board agreed upon a „Framework for capacity allocation on the Rail Freight Corridors 1 and 2“, which was signed by the ministers of transport in December 2012. This document was published in the official Journal of the European Union and is available under the Customer Information Platform under tab “C-OSS” respectively under following link:

<http://eur-lex.europa.eu/JOHtml.do?uri=OJ:C:2013:065:SOM:EN:HTML>

4.1.4 Authorised Applicants

According to Article 15 of the Regulation, an authorised applicant may directly apply to the C-OSS for PaPs/reserve capacity. After the pre-arranged path/reserve capacity has been allocated by the C-OSS, the authorised applicant should appoint the designated railway undertaking(s), which will use the path/reserve capacity on behalf of the authorised applicant.

The rights and obligations of authorised applicants are defined by EU law whereas national law stipulates the rules and deadlines for the nomination of RUs.

4.1.5 Traffic Management Procedures

Traffic management enables train runs in good quality as close as possible to the scheduled paths. Domestic trains as well as international trains are in focus. The “Operation and After Sales” working group of RNE will work out a guideline. It will be presented in the RNE General Assembly in December 2013. The Working Group Leader “Traffic and Performance Management” of RFC 1 supports the work and informs the MB of RFC 1. Traffic Management objectives have to be put in place for 2014 by the MB.

In the guidelines, operational scenarios and tools are listed in order to facilitate the work between different operation centres. The aim is that priority rules of the IMs comply with the common punctuality targets set by the MB. Corridor trains on time have to be given priority as far as possible. The priority rules must ensure that the objectives/punctuality targets for the Corridor can be achieved.

The RFC 1 organisation analyses the possibilities of further harmonisation and coordination of procedures for traffic management along the Corridor and between connected corridors. The results will be consulted with the RU Advisory Group and the implementation proposed to the IMs of the Corridor for their consideration.

Further descriptions can be found in the Customer Information Platform under tab “Traffic & Performance Management”.

4.1.6 Traffic Management in the Event of Disturbance

The RFC 1 organisation adopts common targets for punctuality and/or guidelines for traffic management in the event of disturbance of train movements.

The IMs of the disturbed network should guarantee prompt communication to the involved parties. Procedures and definitions should be common for the entire RFC 1.

In an event of disturbance measures have to be taken in order to come back to a normal situation respectively the scheduled timetable with the least impact on the involved parties. The respective RNE

“Traffic Management Guideline” also contains procedures on how to have a good communication between the operation centres of the concerned IMs. Tools like “Train Information System” (TIS) and “Traffic Control Centres Communication” (TCCCom) supports the exchange of information and close coordination among the control centres. The priority rules in the event of disturbance should ensure that the objectives/punctuality targets for the Corridor can be kept.

The Corridor WG “Traffic and Performance Management” continues to elaborate the harmonisation of traffic management rules. The results can be seen in the Customer Information Platform under tab “Traffic & Performance Management”.

4.1.7 Performance Management

As referred to in Article 11 of Directive 2001/14/EC, as well as in Article 19 §1 of the Regulation (EU) No 913/2010, the MB shall promote compatibility between the performance schemes of the IMs along the RFC 1.

The performance of freight trains as well as passenger trains on RFC 1 is already monitored and reported since 2008. The punctuality objectives have been prepared and are defined in the Corridor Customer Information Platform under tab “Traffic & Performance Management”.

The implemented performance management includes the following steps:

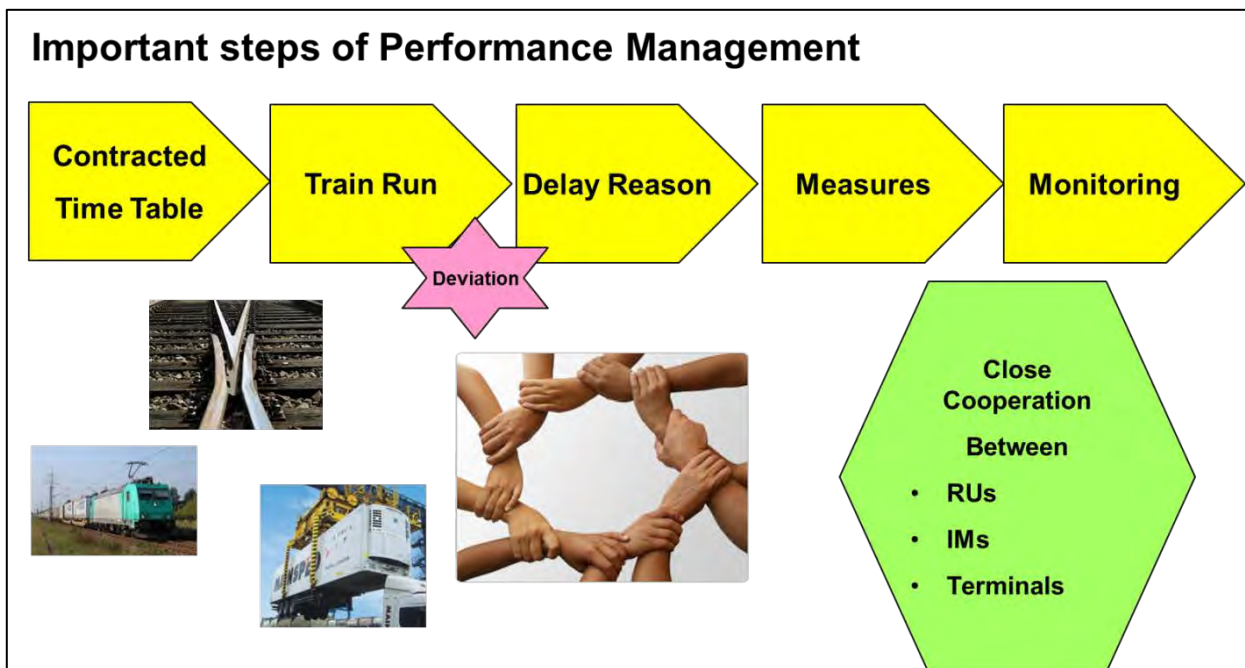

Figure 24: Important steps of Performance Management

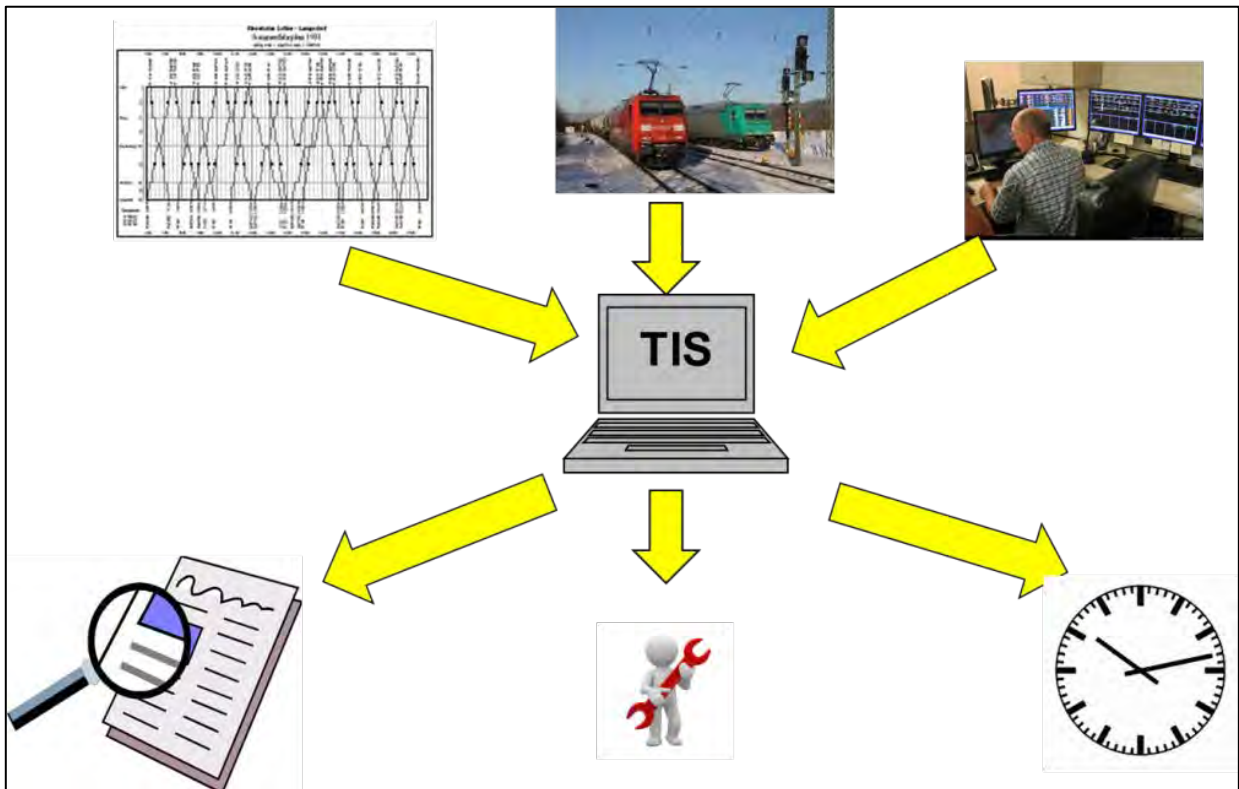

Figure 25: Train Information System (TIS)

Information concerning train runs and delay reasons are gained by the WG from the “Train Information System” of RNE. The relevant reports are regularly generated and analysed by the performance managers.



Figure 26: Involvement of customers

Of key importance in the performance management is to include the prime parties of the transport process along the Corridor into the performance management as delays could be caused by any of them. Subsequently, the Corridor WG Traffic & Performance Management executes an integrated performance management together with RUs. This happens in different ways as shown in Figure 26.

The WG “Traffic & Performance Management” has been reporting, analysing and improving the freight train traffic over the last years. Dedicated freight trains are monitored on defined traffic relations along the whole corridor. The RU representatives are invited to the quarterly meetings of the WG. Together with the customers a “Train Performance Management Manual” was elaborated and presented to the RFC 1 MB.

From the European Performance Regime (EPR) basic modules are introduced on RFC 1. According to the experiences in future, taking over of further elements will still be considered in the performance management of RFC 1.

4.2 Measures in Addition to Regulation (EU) No 913/2010

In the Regulation (EU) No 913/2010 it is foreseen to publish an implementation Plan regarding all requirements as defined therein. The following measures are part of the overall corridor programme but not explicitly elaborated under the requirements of the above mentioned Regulation.

As the corridor management comprises the integrated implementation of all topics concerning the corridor programme, the activities in addition to the Regulation are included in the following chapters.

4.2.1 Continuing Activities for Improving the Quality on the Corridor by the Ministries (IQ-C action plan)

The following activities shown in the table below are taken from the IQ-C action plan 2010 and are being implemented under the responsibility of the ministries and regulatory bodies.

| Description | REG Art. | Ref. IQ-C Action Plan 2006-2014 | Indicative Status of the Action | | | Notes | Indicative status of the action | Risk |
|---|----------|---------------------------------|-------------------------------------|---|-----------------------|--------------------------------------|---------------------------------|------|
| | | | Indicative start date of the action | Indicative start/end date of the action | Who? | | | |
| | | | Done | To do | | | | |
| | | | On going | Risk | | | | |
| Noise | | | | | | | | |
| Railway noise <i>Implement Ministers conclusions June 2010 concerning railway noise source abatement and define next actions</i> | | # 11 # 11 | | 2010-2014 | MoT | | | |
| Customs | | | | | | | | |
| Customs EU-CH <i>Implementation 1875/ 2006/ EC for rail freight transiting CH with the time horizon (foreseen now is 2013)</i> <i>Monitor impact (possible) new customs regulations from EU and CH</i> | | # 12 # 12 # 12 | | 2011 2016 | MoT / customs / EC | | | |
| Regulatory framework for capacity allocation | | | | | | | | |
| Development of the regulatory framework <i>Analysis of impacts of the draft regulation rail freight oriented networks: development of business plan, impact on existing actions</i> | | # 13 # 13 | | | MoT | Start after completion of regulation | | |

Table 1: Specification for the improvement of quality on RFC 1

Coordinated railway noise abatement measures

Railway noise is an urgent environmental issue for the further development of railway freight transport along the Corridor. Without further reduction of noise restrictions on railway traffic are likely to follow. In Switzerland the Parliament decided to ban noisy freight wagons by 2020 completely.

Railway noise can be reduced significantly by using low noise breaking technology (so called K- blocks on the market since several years and LL blocks authorized in EU since June 2013). New wagons need to have low noise emissions following the European interoperability specifications TSI Noise and TSI Wagons. For existing wagons retrofitting of the breaking technology is possible to reduce noise. In Germany, Netherlands and Switzerland financial incentive schemes are in place to support retrofitting by the railway undertakings / wagon owners. These financial incentive and support schemes make retrofitting more economically possible. Also at European level an optional scheme for noise differentiated track access charging is foreseen in directive 2012/34/EU. An implementing act at EU level

is expected in 2014/2015. Furthermore the European Commission launched a consultation document on railway noise from freight wagons in September 2013. An EC communication is expected in 2014.

In order to support effectiveness of the measures in place the Corridor will include coordinated measures for railway noise abatement measures on its action program. A working group of both, ministries and infrastructure managers, will develop a proposal to the Executive Board for corridor coordination. Corridor approach will target the following objectives:

- Common promotion of the existing incentive schemes for retrofitting, e.g. by making the business case for railway undertakings / wagon owners more transparent;
- Common approach to administrative procedures for financial incentives in retrofitting for rail freight wagons;
- Coordination of the modification of existing schemes where needed;
- Assessment of possible extension of the incentive schemes to countries without incentive schemes (Belgium and Italy).

Customs

From the beginning of the cooperation on Corridor 1 the simplification of customs procedures was one important measure to increase the competitiveness of rail freight on the Corridor. International rail transport on the Corridor 1 currently benefits from a simplified customs transit procedure under the EC-EFTA Convention on a common transit procedure. One of the major advantages of this simplified procedure is that EU goods transported through Switzerland are not presented to customs neither at the EU point of departure or destination nor when crossing the EU - Swiss border. Approximately 80% of the volumes of goods transported through Switzerland by rail benefit from this procedure.

In 2004, based on a Swiss proposal a tailor-made simplified customs procedure for transit EU-goods had been defined and introduced. Until now, this simplified procedure is applied by a notable number of railway undertakings of all corridor countries. It is applied in addition to the usual EC-EFTA Convention on a common transit procedure.

The EU is currently working on a recast of the Modernised Customs Codex as Union Customs Code. It is foreseen that the current simplified procedure will be abolished and replaced in order to harmonise transit procedures in rail and road transport (latest 1 May 2016).

The Ministries of Transport of the Corridor work in close cooperation with customs authorities on solutions for customs procedures for EU goods on Corridor 1 which consider both the special characteristics of rail freight transport and the need for an efficient and secure transport of EU goods on the Corridor crossing Switzerland.

Development of the Regulatory Framework

For detailed information about the development of the Regulatory Framework please click on the links below.

<http://www.bundesnetzagentur.de/schienerkorridor1>
<http://www.bundesnetzagentur.de/railcorridor1>

4.2.2 Objectives and Action Plan of the National Safety Authorities (NSAs) of RFC 1

The NSA group of RFC 1 intends to take steps to fulfil the following actions:

NSA Action 1: Cross Acceptance of vehicles

Permanent process: application of the Memorandum of Understanding on the implementation of approval procedures for rolling stock and cross-acceptance of approval procedures, concluded in 2007 by the ministries of transport of CH, DE, IT, NL and Austria, by all NSAs of former Corridor A member states and application of additional cross acceptance agreements concluded between former Corridor A member states on ministry or NSA level.⁴

NSA Action 2: Authorisation of ETCS onboard equipment

Ongoing process: The safety authorities responsible for authorising the placing into service of vehicles with ERTMS onboard equipment will present to the Ministers and to the European Coordinator a cooperation agreement with practical measures to streamline the certification processes until 2014.

NSA Action 3: NSAs support mutual recognition of train driver licences

1) Ongoing process: drafting and/or revision of agreements for mutual recognition of train driver licences on NSA level between CH and the other RFC 1 member states.⁵

2) Permanent process: application of agreements for mutual recognition of train driver licences between CH and the other RFC 1 member states concluded on ministry or/and NSA level.⁶

3) As far as borders between EU member states are concerned mutual recognition of driver licences is not required due to the issue of European driver licences which are valid throughout the EU (dir. 2007/59/EC).

NSA Action 4: NSA support in cross border infrastructure projects

Permanent process: Various cross border infrastructure projects on RFC 1 are planned and managed by respective Infrastructure Managers (IM). Therefore, NSAs of RFC 1 member states actively support the work of IMs until finalisation of the cross border infrastructure projects. IMs shall apply a common concept for authorization of transitions (Class A/B, B/B) in border-zone areas. Request to the ministries to find a legal solution/provide a legal framework for mutual recognition.

NSA Action 5: NSAs support cross acceptance in border-zone areas / short distance interoperability⁷

1) Train driver licences

See above NSA Action 3.

2) Safety certificates

Mutual recognition of safety certificates for purpose of short distance interoperability must be agreed on ministry level. Request to the ministries to find a legal solution for mutual recognition.

3) Authorisation of vehicles

⁴ BE was not involved and did not sign the MoU.

⁵ On NSA level a legal basis is required to be provided by the ministries - either by legislation or treaty.

⁶ On NSA level a legal basis is required to be provided by the ministries - either by legislation or treaty.

⁷ On NSA level a legal basis is required to be provided by the ministries - either by legislation or treaty

a) Permanent process: Application of specific mechanisms (agreements on ministry or NSA level, specific provisions in the national legal frameworks of the RFC 1 member states) by respective NSAs of RFC 1 enabling/facilitating vehicles access to the border stations of RFC 1 neighbouring countries.

b) Ongoing process: Request to the ministries to find a legal solution for mutual recognition. Solution could be provided by national legislation.

4.2.3 Action Plan of the Regulatory Bodies of RFC 1

According to the Regulation (EU) No 913/2010, the regulatory bodies of each corridor shall collaborate in monitoring the competition in the rail freight corridor. They shall ensure non-discriminatory access to the corridors.

Monitoring of the corridors will be a key task for regulatory bodies. It can set direction for the stakeholders involved and can stimulate market players to improve their activities. The regulatory bodies in Rail Freight Corridor 1 have jointly determined several aspects of the monitoring of Rail Freight Corridor 1.

For detailed information about the tasks and performance of the RBs within RFC 1 please click on the links below.

<http://www.bundesnetzagentur.de/schienerkorridor1>
<http://www.bundesnetzagentur.de/railcorridor1>

5 Objectives/Performance

5.1 Objectives for RFC 1

1. ETCS and project implementation
2. Capacity and traffic development
3. Publication of a customer oriented list of possessions
4. Quality improving measures for freight traffic segments:
 - Freiburg – Gallarate
 - Köln – Gallarate
 - Rotterdam – Melzo
 - Antwerp – Novara
5. Monitoring of the quality of service offered by the C-OSS on the basis of the framework of capacity allocation agreed by the Executive Board
6. Publication of a performance monitoring report (see chapter 5.4)
7. Execution of a customer satisfaction survey (see chapter 5.5)

5.2 KPIs for Monitoring the Above Objectives

Corridor Input KPIs

- ETCS deployment until 2015
- State of funding (projects)

Regarding quality of service level of the C-OSS

- Number of offered PaPs X-11 per section
- Number of PaP-requests period X-11 till X-8 and X-8 till X-2
- Number of conflicting PaP-applications (double booking at X-8)
- Number of PaPs allocated by C-OSS
- Number of PaPs which reached active timetable phase
- Reserve capacity: Train paths offered
- Reserve capacity: Train paths allocated
- Reserve capacity: Train path reaching the status of active timetable

Corridor Output KPIs

- Modal Split
- International traffic volume
- Average punctuality
- Commercial train speed

5.3 Definitions of the KPIs

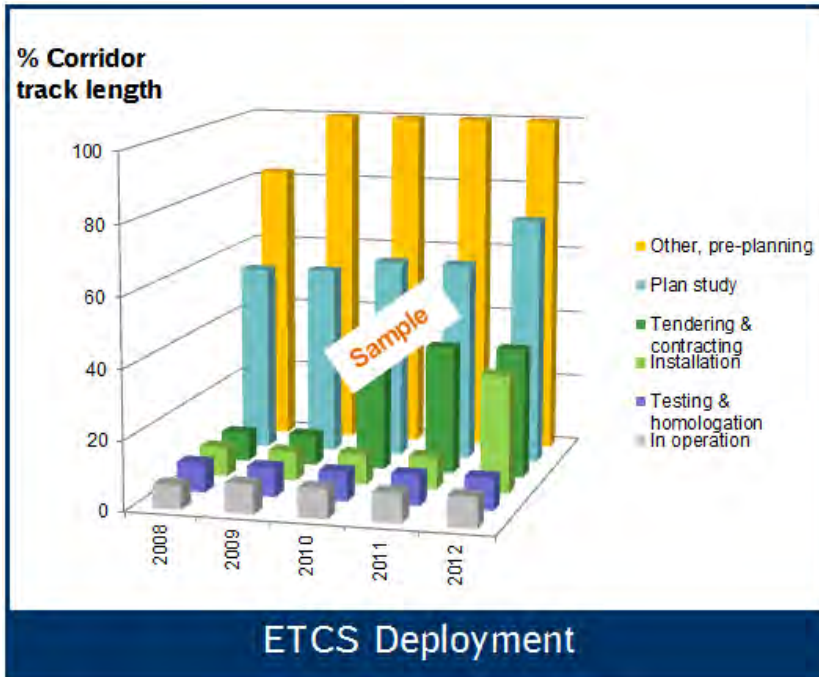

Definition: Yearly progress in [%] of ETCS corridor single track length [Basis 4171 km] which passed through the phases of preplanning/plan study/tendering & contracting/installation/testing & homologation or in operation.

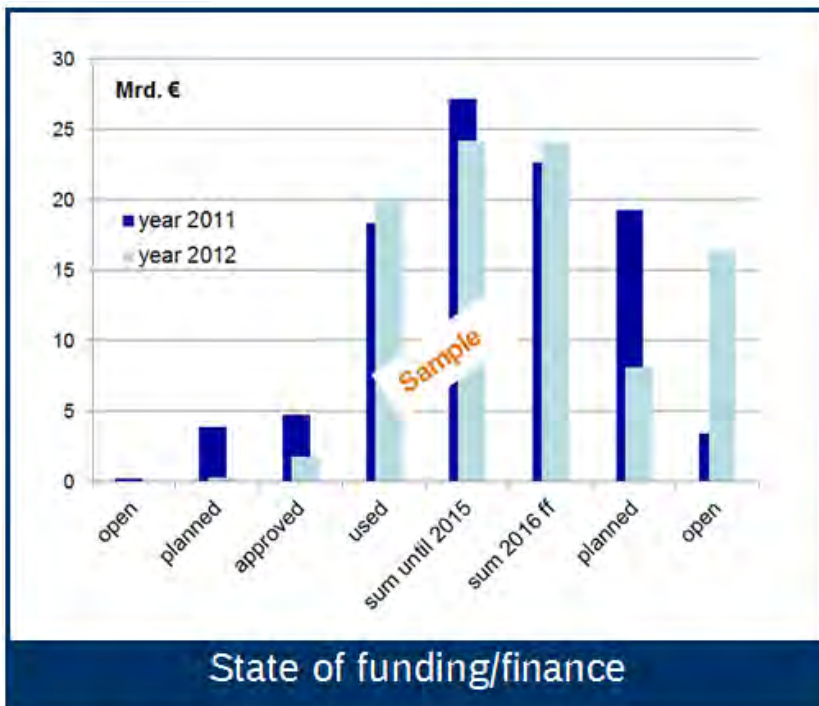

Definition: Amount of planned/ approved/ open/ used budget [bn. €] for all kinds of RFC 1 projects (Infrastructure, signalling, ERTMS, IT) at the end of the year related to the total budget planned until 2015 (open, planned, approved, used, total) respectively from 2016 to 2025 (total, open, planned).

Quality of service level of the C-OSS

These KPIs refer to the “monitoring of the allocation process” stipulated in annex 1 of the Framework of the ExB for RFC 1 and RFC 2. The C-OSS will provide a written report on these KPI at least once per year in November to evaluate the path allocation process.

- **Number of offered PaPs X-11 per section**

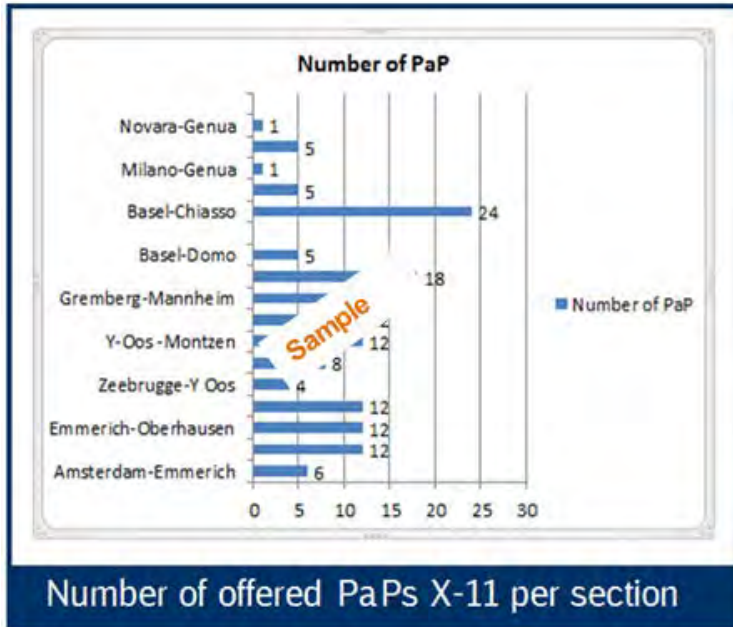

Definition: This indicator shows the number of pre-arranged paths per section published by the C-OSS for one network timetable period eleven months before timetable change. It might also be further specified the percentage of end-to-end PaP on the whole corridor versus partial PaP on some sections and the percentage of PaP offered on all running days during a week versus PaP offered on specific running days. If the MC decides to keep some non-requested PaP available after X-7,5 for the late request phase the amount of these PaP will also be indicated.

- **Number of PaP requests period X-11 till X-8 and X-8 till X-2**

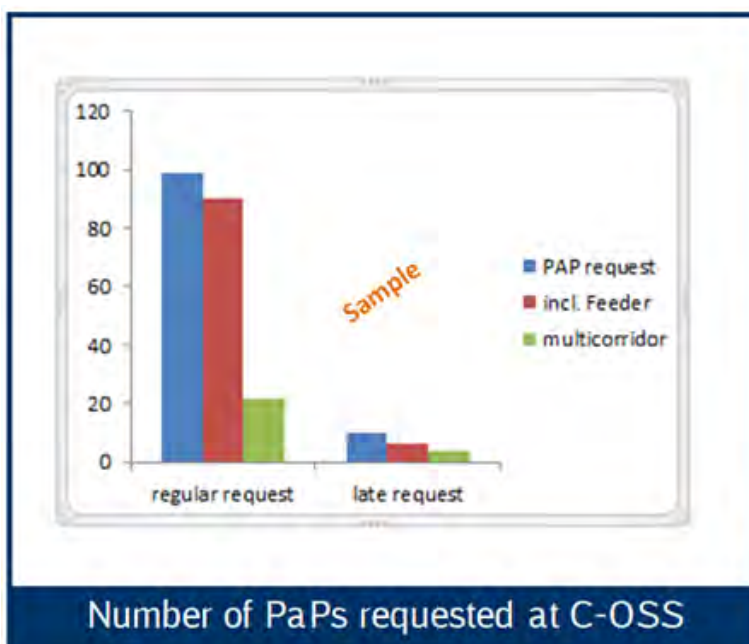

Definition: This indicator shows the number of international path requests for network timetable placed in the booking tool PCS with a reference to a pre-arranged path on RFC 1. It differs between path requests placed on-time respectively before the deadline for path requests for annual timetable (X-8) and so-called “late requests” between X-8 and X-2 referring to PaP. For late requests it might also be differentiated between requests aiming at “former PaP” which at X-7,5 have been transferred to the infrastructure managers and requests aiming at PaP still kept available by the C-OSS for international rail freight.

Concerning the path requests it is indicated how many path requests involve a request for feeder/outflow paths and how many path requests for PaP on RFC 1 concern multiple corridors.

- **Number of conflicting PaP-applications (double booking at X-8)**

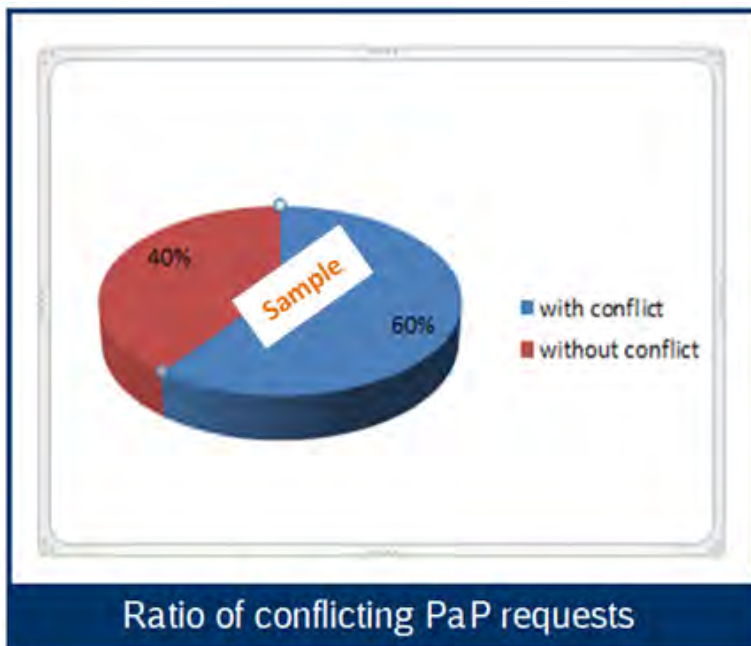

Definition: This indicator shows the percentage of path requests which lead to a so-called double booking situation in the sense that several path requests placed in PCS refer to the same PaP on RFC 1. A ranking of PaP most affected by double-bookings might also be indicated.

- **Number of PaPs allocated by C-OSS**

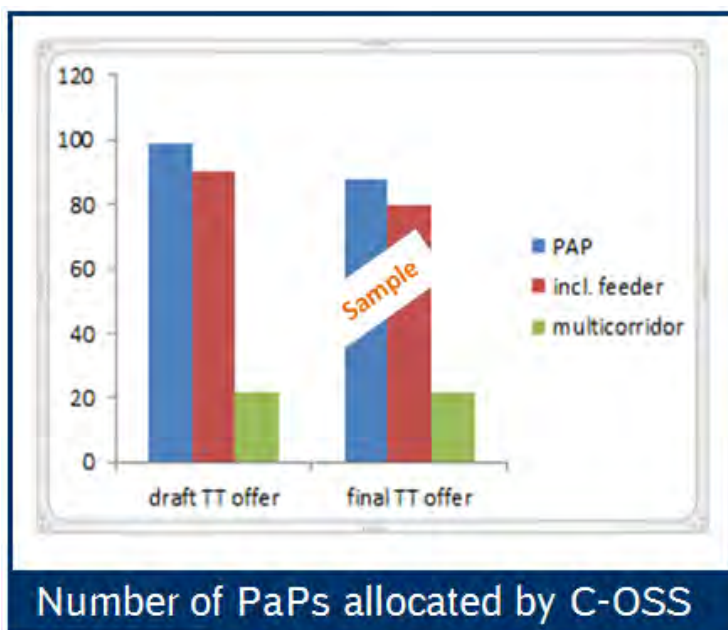

Definition: This indicator shows the number of draft (x-5) and final (x-4) timetable offers communicated via PCS by the C-OSS regarding PaP on RFC 1. It will also be indicated how many of these timetable offers include feeder/outflow paths and/or involve multiple corridor paths.

- **Ratio of allocated PaP requests**

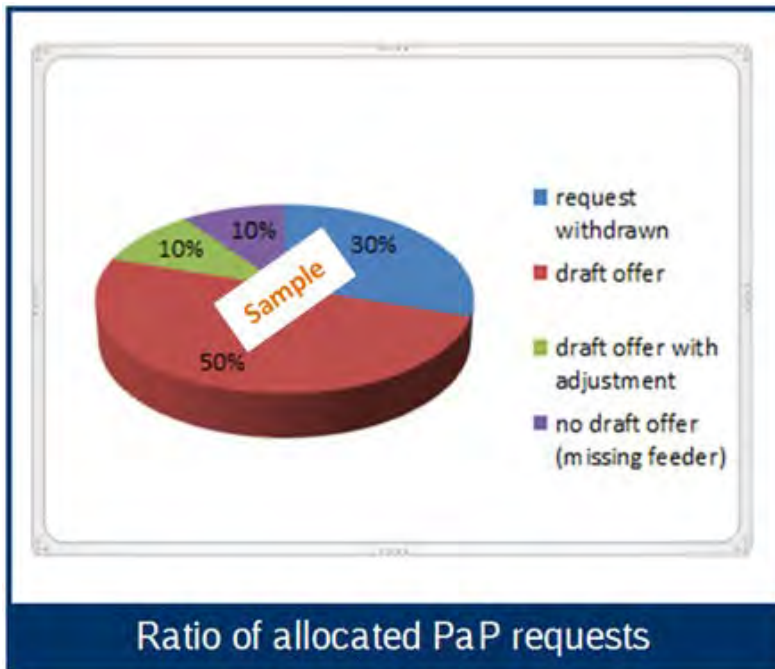

Definition: Comparing the number of PaP allocated with the number of PaP requests a ratio/percentage will show how many path requests led to a draft timetable offer incl. those which have been adjusted (minor changes) or withdrawn (major change qualified as new request in remaining capacity) by the customer and those which could not be answered due to missing input from infrastructure managers (e.g. due to missing feeder delivery).

- **Number of PaPs which reached active timetable phase**



Definition: This indicator shows the percentage of final timetable offers communicated by the C-OSS, which have been accepted by the customers in PCS before the timetable change (by setting a green light

in the respective PCS dossier). This indicator will be elaborated once per year for the whole network timetable period.

- **Reserve capacity: Train paths offered**

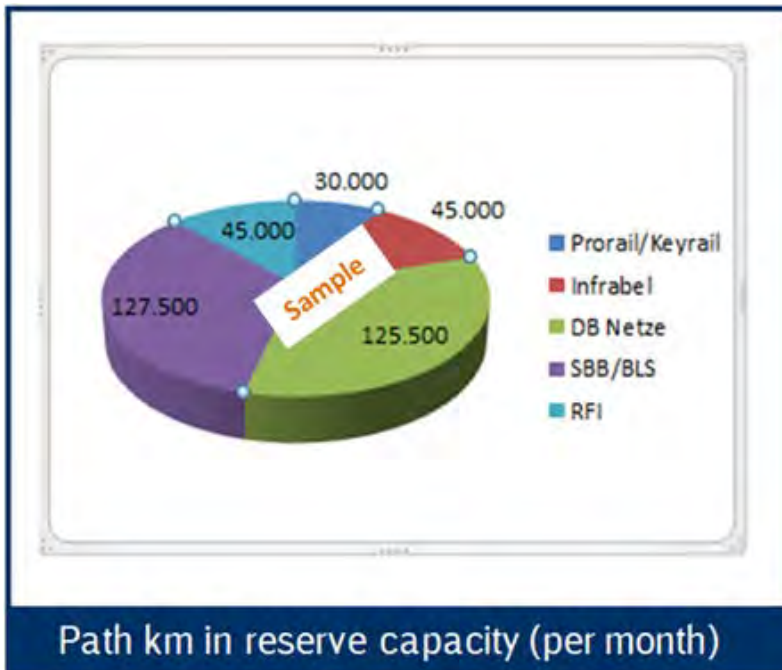

Definition: This indicator shows the volume of train path-km per month published by the C-OSS in reserve capacity for international rail freight. This indicator may differentiate the volume of train path km offered per infrastructure manager and/or per section.

- **Reserve capacity: Train paths allocated**

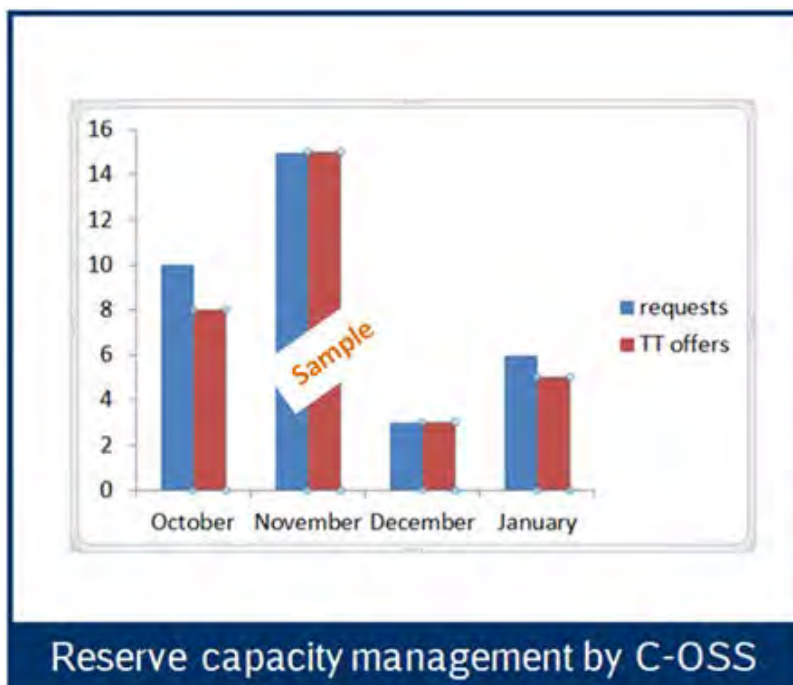

Definition:The indicator shows the number of requests for international rail freight paths in reserve capacity placed per month via PCS at the C-OSS and how many of these requests have been answered by a respective timetable offer communicated by the C-OSS via PCS.

- **Reserve Capacity: Train path reaching the status of active timetable.**



Definition: This indicator shows how many timetable offers communicated by the C-OSS via PCS in reserve capacity have been finally accepted by the customers in PCS. The indicator is elaborated once per year for the whole network timetable period.

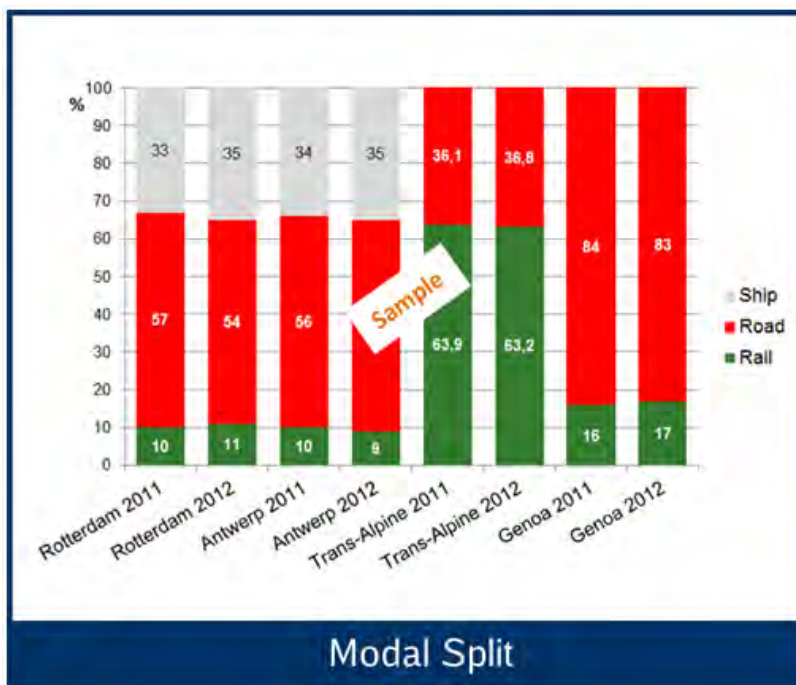

Definition: Modal split [%] of freight traffic at sea ports and trans-alpine. For sea ports the modal split is calculated based on TEUs (containers) for the Hinterland traffic. For the trans-alpine freight traffic the basis is net tons. It is separated by rail, road and inland waterways (if applicable). Parameters are measured on an annual basis.

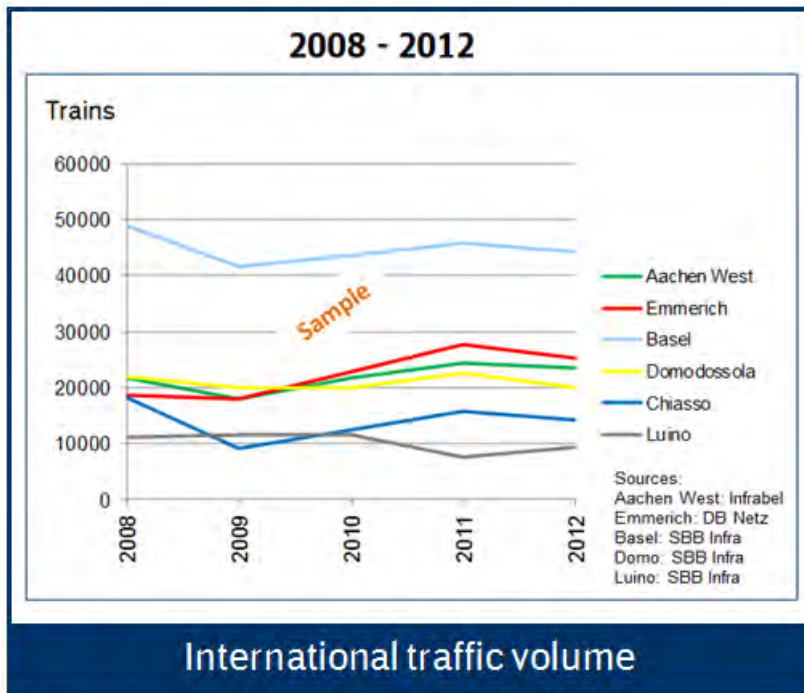

Definition: Number of international freight trains per year crossing one (or more) of the border stations of RFC 1 in both directions, regardless of origin or destination. Border stations are:

NL-DE: Zevenaar/Emmerich

DE-BE: Aachen West/Montzen

DE-CH: Basel

CH-IT: Domodossola, Chiasso and Luino

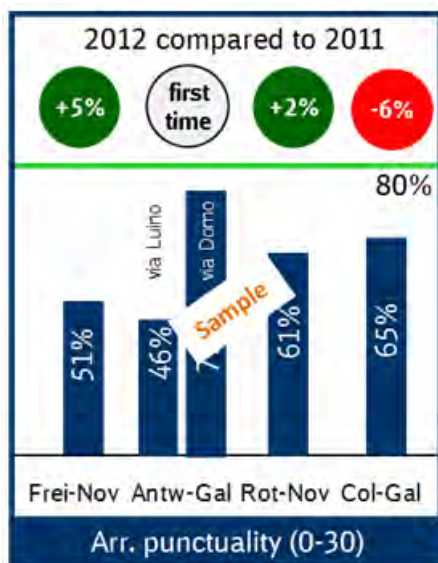

Definition: Average punctuality level (arrival at destination within a 30 minutes time span) for selected relations of: Freiburg–Novara; Antwerp–Novara (on two alternative routes); Rotterdam–Novara and Cologne–Gallarate a level of 80% is targeted (all start/ end points of these transport relations are directly located on Corridor 1).

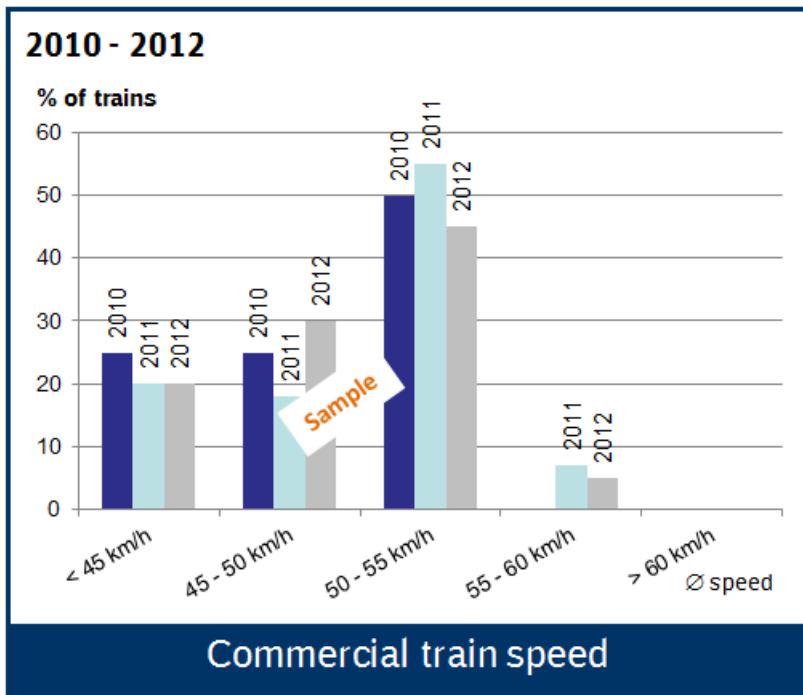

Definition: Average speed [km/ h] of trains according to valid time table for selected relations: Freiburg–Novara; Antwerp–Novara, Rotterdam–Novara and Cologne–Gallarate (all start/end points of these transport relations are directly located on Corridor 1) in both directions. Measured based on annual timetable and classified in five different categories. Basis: 24 freight train services on 4 different relations.

5.4 Performance Monitoring Report

A performance monitoring report will be prepared and published from the end of 2014 on. The report will be based on the results according to the performance figures described in above chapters.

5.5 Customer Satisfaction Survey

Each year in September, starting from 2014, the Management Board of the Corridor will conduct a Corridor Satisfaction Survey among the users of the RFC. This survey will be distributed at least to all RUs and AAs which have already used the Corridors' RFC Services. The results of these surveys will be presented to RFC Users in RU Advisory Group meetings and will be published on the corridor website.

To ensure consistency along the different corridors, RFC X supports the development of a common questionnaire for all RFC Satisfaction Surveys led by RNE. In this way, RUs or AAs that use several RFCs' services will not be contacted more than once and greater comparability of the feedback given in the different Satisfaction Surveys will be ensured.

6 Investment Plan

6.1 Capacity Management Plan

Demand and development

As a result of the analysis of traffic demand, available capacity and bottlenecks (see sections 2.1.2, 2.1.3 and 2.1.4 two scenarios were developed with the aim to visualise the impact of the planned investments on future capacity on RFC 1. This is without prejudice to the competence of the Member States regarding infrastructure planning and financing. Also this is without prejudice to any financial commitment of a Member State.

The first scenario called “Scenario S” describes the improvements in capacity from 2015 to 2025 when all projects with funding status “Approved” are considered.

The second scenario is called “Scenario P”; it describes the improvements in capacity from 2020 to 2025 when all projects with funding status “Planned” are considered.

In the next Figure 27 to Figure 29 the scenarios are visualised.

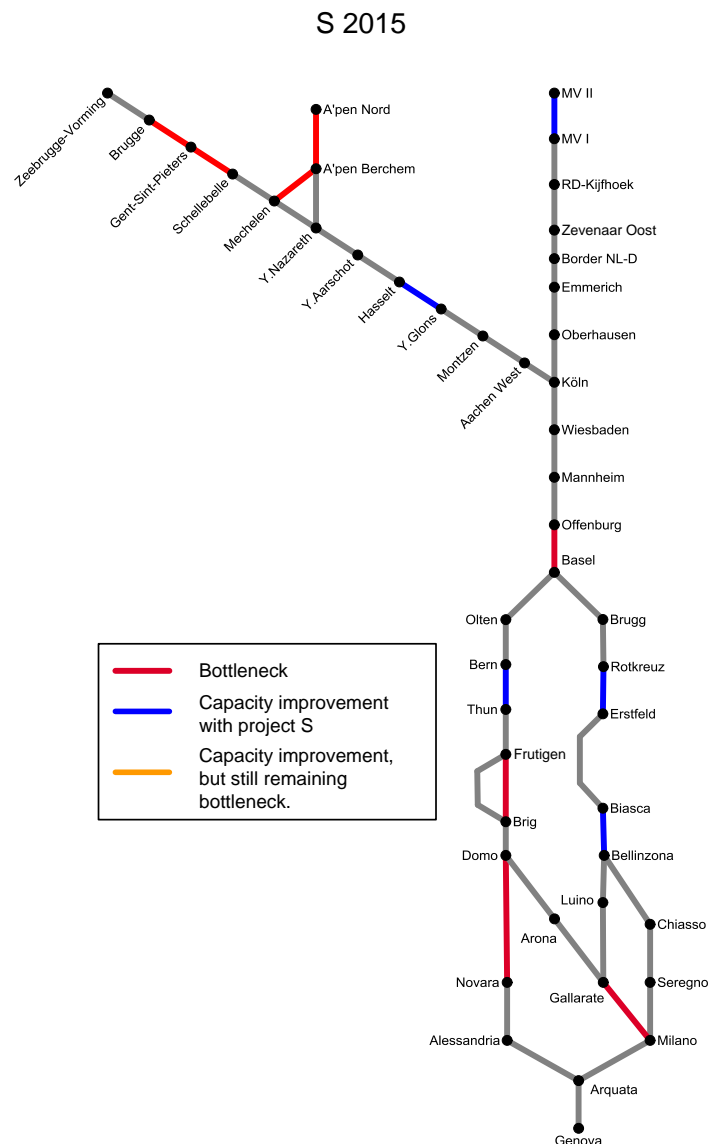

Figure 27: Improvements in capacity when all secured projects until 2015 will be implemented on RFC 1 Scenario S 2015. State of play February 2013 based on bottleneck analysis February 2011. There may be bottleneck sections where capacity improvement measures were finalised and brought into operation after this map was done. Hence some former bottlenecks may not be shown in their improved status.

In the figures, an elimination of the bottleneck due to the investment is marked in dark blue. An improvement in capacity due to the investment but still no elimination of the bottleneck is marked orange. Sections with a bottleneck and no secured project planned are shown in red. No Scenario P exists for the year 2015 since generally investments within such a short time period are financially secured projects.

Figure 28 - left part - shows which improvements are made if the secured projects until 2020 will be implemented. If the planned but not yet secured projects until 2020 (scenario P) are also implemented then the total improvements can be seen in the - right part. For example, the bottleneck removal between Domodossola and Novara is planned, but financing is not yet secured.

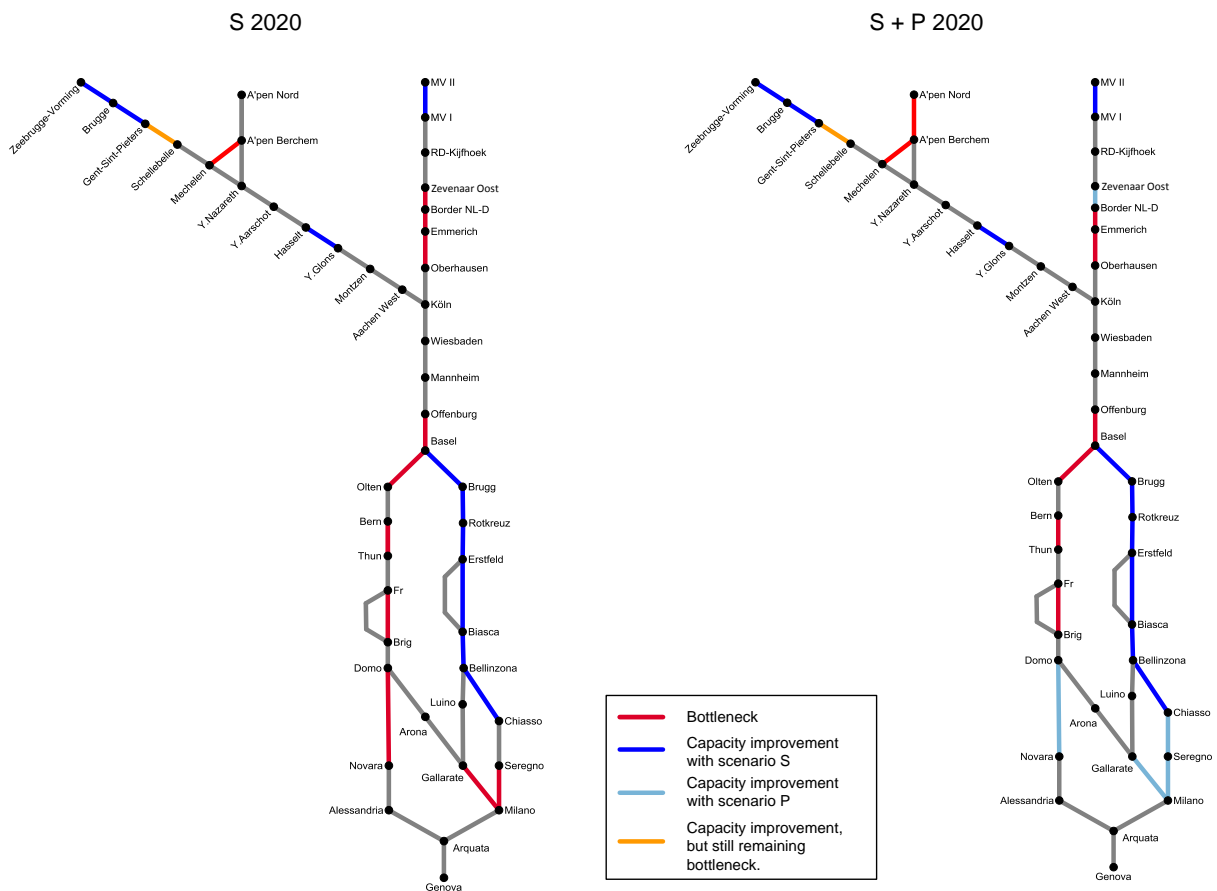

Figure 28: Improvements in capacity when all projects until 2020 are considered on RFC 1 Scenario S and scenario S + P. State of play February 2013 based on bottleneck analysis February 2011. There may be bottleneck sections where capacity improvement measures were finalised and brought into operation after this map was done. Hence some former bottlenecks may not be shown in their improved status.

Figure 29 - left part - shows which improvements are made if the secured projects until 2025 are implemented. If the existing plans until 2025 (scenario P) are also implemented then the total improvements can be seen in the right part.

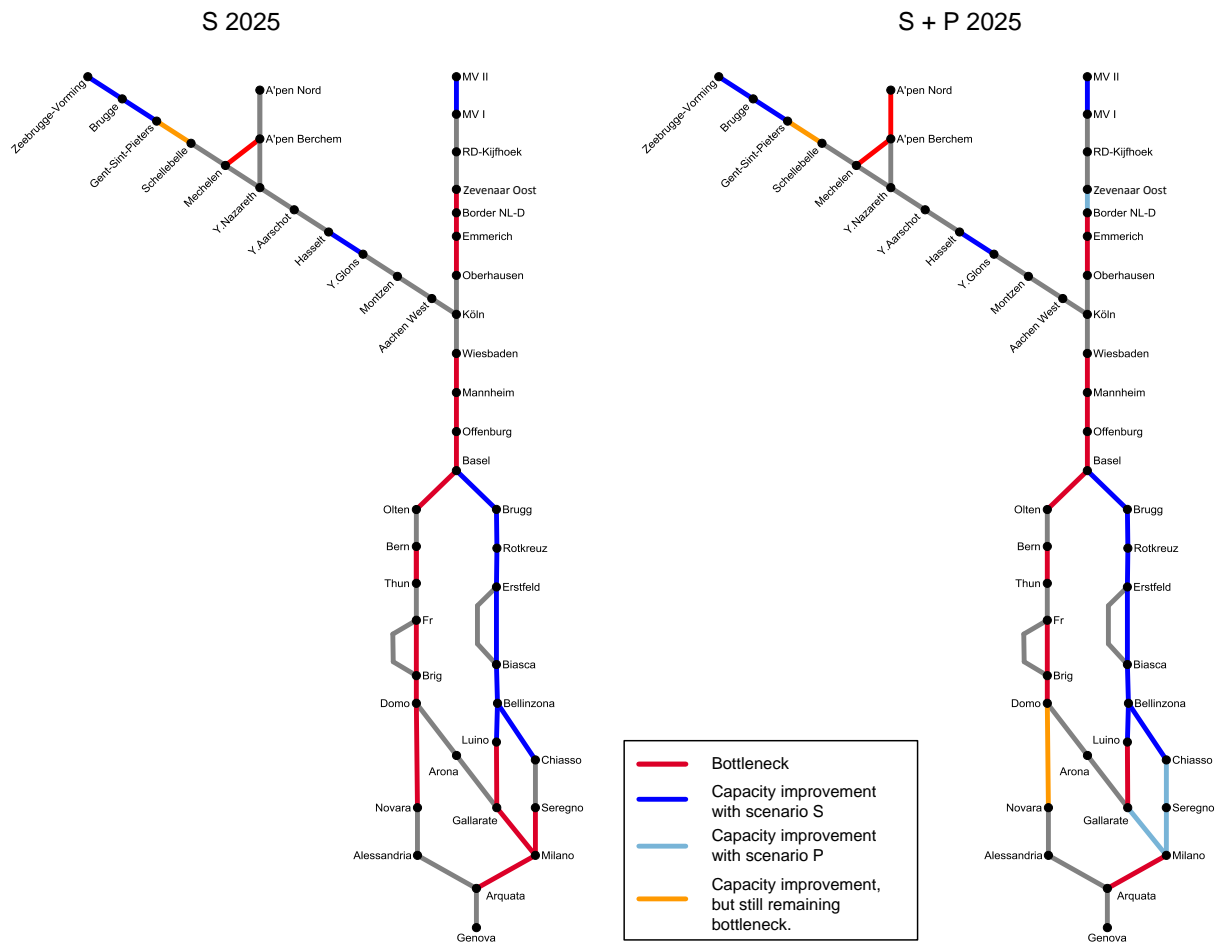

Figure 29: Improvements in capacity when all projects until 2025 are considered on RFC 1 Scenario S and scenario S + P. State of play February 2013 based on bottleneck analysis February 2011. There may be bottleneck sections where capacity improvement measures were finalised and brought into operation after this map was done. Hence some former bottlenecks may not be shown in their improved status.

6.2 Infrastructure Projects and Timeline

In table 2, the indicative investments for capacity improvement on RFC 1 are shown and listed in the following pages. As stated in article 11 of the Regulation (EU) No 913/2010, the projects and investments planned for RFC 1 are subject of specific criteria indicated by the European Commission.

Criteria for selected projects:

- Project must deliver additional benefit
- Projects might be clustered according to usable sections of completion

For reading through table 2, some of the categories have to be explained (see below)

Explanations

1. Basic structure for project categories in the implementation plan:

- Infrastructure such as improvement of line characteristics (e. g. speed, gauge, axle load, electrification etc.), Capacity increase (bottleneck removal, new line/ track etc.)
- Signalling such as interlocking upgrade, block distance, headway
- ERTMS
- IT-Projects such as IM interfaces for PCS or TAF TSI

2. Funding Status

| Category | Meaning |
|-----------|--|
| Estimated | Rough estimate about the amount of funding |
| Open | Funding which is not yet part of any formal funding plan |
| Planned | Funds in middle term budget (generally not approved) |
| Approved | Funds approved and released |
| Used | Funds spent |

3. Project status

| Category | Meaning |
|--|---|
| Initial Plan Study | Functional and technical specification completed |
| Building Licence | Approval from authorities (internal or external) to start implementation or modifications |
| Approval for Realisation and Start of Construction incl. financing | Start of implementation or modification works |
| Completion of Construction | Implementation/ Modification finished and accepted |
| Go-Live | Putting the new system/ device/ equipment into full operation |

The following indicative investment plan in Table 2 includes projects so far in consideration on RFC 1.

| Year of implementation | Country | Line section (from North to South) | Project category | Project | Benefits | Cost estimation [Mio. €] | Funding Status | Funding Source | Project Status |
|------------------------|---------|---|------------------------|---|------------------|------------------------------|----------------|----------------|--------------------------------|
| 2007 | NL | Kijfhoek - Zevenaar | Infrastructure | Betuwe Line | Capacity | 4.580 | Used | Public + IM | Go-Live |
| 2007 | CH | Frutigen - Brig | Infrastructure | Base Tunnel | Capacity | 2.800 | Used | Public + IM | Go-Live |
| 2008 | IT | Bergamo – Treviglio | Infrastructure | 2 nd track | Capacity | 86 | Used | Public + IM | Go-Live |
| 2010 | CH | Castione | Infrastructure | upgrade | Capacity | 18 | Used | Public + IM | Go-Live |
| 2010 | IT | Luino - Laveno | Infrastructure | upgrading for 600 m | Capacity | 21 | Used | Public + IM | Go-Live |
| 2011 | CH | Bern | Infrastructure | 3rd track Rüttli-Zollikofen | Capacity | 61 | Used | Public + IM | Go-Live |
| 2011 | IT | Domodossola – Novara | Infrastructure | Gozzano bypass | Capacity | 31 | Used | Public + IM | Go-Live |
| 2011 | IT | Novara - Alessandria | Infrastructure | Upgrade line | Capacity | 13 | Used | Public + IM | Go-Live |
| 2012 | BE | Zeebrugge | Infrastructure | Bocht ter Doest | Capacity | 9,5 | Used | Public | Go live |
| 2012 | NL | Maasvlakte II - Maasvlakte I | Infrastructure | New line + Marshalling Yard | Capacity | 30 | Used | others | Go-Live |
| 2013 | IT | Borgo Ticino | Infrastructure | Upgrade for 600m | Train length | 4 | Approved | Public | Start of Construction |
| 2014 | CH | Bern - Thun | Signalling | Headway 2' | Signalling | 18 | Approved | Public + IM | Completion of Construction |
| 2014 | NL | Zevenaar - Border | ERTMS | Zevenaar1: ERTMS level 2 V2.3.0d from Zevenaar to border | Interoperability | 113 | Approved | Public + EU | Initial Plan Study |
| 2014 | BE | Kallo - A'pen Noord | Infrastructure | Liefenshoek Rail Link | Capacity | 765 | Partly used | Public + PPP | completion of PPP construction |
| 2014 | BE | Mol - Herentals | Infrastructure | Iron Rhine: Electrification Herentals - Mol (L15) | Capacity | 15,2 | Partly used | Public | Start of construction |
| 2015 | CH | Corridor A/1 lines | ERTMS | ERTMS equipment | Interoperability | 115 | Approved | Public + IM | Start of construction |
| 2015 | IT | Corridor A/1 lines (fase prioritaria Chiasso – Milano - Genova e Iselle - Domodossola - Novara) | ERTMS | ERTMS equipment | Interoperability | 66 | Approved | Public + EU | Building License |
| July 2015 | CH | Basel Bad - Basel SBB | Infrastructure | upgrade to 4 tracks | Capacity | 40 | Approved | Public + IM | Completion of Construction |
| 2016 | NL | Zevenaar - Border | Infrastructure | Zevenaar2: change power supply 1500V into 25kV (and 15kV border - Emmerich) | Interoperability | *incl. in project Zevenaar 1 | Approved | Public + EU | Initial Plan Study |
| 2016 | CH | Erstfeld - Biasca | Infrastructure + ERTMS | Gotthard base tunnel | Capacity | 8.235 | Approved | Public + IM | Start of Construction |

Implementation Plan RFC 1



| | | | | | | | | | |
|--------|----|--|------------------------|--|-----------------------------|-----------------------------------|----------|------------------|-----------------------|
| 2016 | CH | Bellinzona - Ranzo | Infrastructure + ERTMS | line upgrade, incl. 700m Bellinzona - border, automatisaton | Capacity + Train length | 60 | Approved | Public + IM | Building License |
| 2016 | IT | Domodossola - Novara via Borgomanero | Infrastructure | upgrade 4 stations for 650m | Capacity + Train length | 25 | Planned | Public | Initial Plan Study |
| 2016 | IT | Vignale - Oleggio | Infrastructure | new crossing station (750) | Capacity + Train length | 4 | Planned | Public | Initial Plan Study |
| 2016 | IT | Domodossola - Novara via Arona | Infrastructure | Upgrade for 750m (Premosello) | Train length | 2 | Planned | Public | Initial Plan Study |
| 2016 | IT | Chiasso - Milano Smistamento | Infrastructure | Upgrade for 750m | Train length | 5 | Open | Public | Initial Plan Study |
| 2016 | IT | Chiasso – Monza | Signalling | Headway 3' | Capacity | 48 | Approved | Public | Initial Plan Study |
| 2016 | IT | Genova Campasso | Infrastructure | Potenziamento della stazione di Campasso | Capacity | 12 | Planned | Public | Initial Plan Study |
| 2016 | IT | Monza - Milano Smistamento | Signalling | Headway 3' | Capacity | 6 | Planned | Public | Initial Plan Study |
| 2017 | IT | Milano-Pavia | Signalling | Headway 3' | Capacity | 22 | Planned | Public | Initial Plan Study |
| 2017 | IT | Gallarate – Parabiago | Signalling | Headway 3' | Capacity | 24 | Planned | Public | Initial Plan Study |
| 2017 | IT | Novara | Infrastructure | Node upgrade (access) | Capacity | 80 | Planned | Public | Initial Plan Study |
| 2017 | IT | Potenziamento infrastrutturale Voltri-Brignole | Infrastructure | Potenziamento infrastrutturale Voltri-Brignole | Capacity | 642 | Approved | Public + EU | Start of Construction |
| 2018 | NL | Zevenaar – Border | Infrastructure | Zevenaar3; 3rd track Zevenaar-Emmerich + power supply | Capacity | *incl. in project Zevenaar 1 | Approved | Public + EU | Initial Plan Study |
| 2018 | DE | Border – Oberhausen | ERTMS | ERTMS equipment existing line | Interoperability | Part of proj. Emmerich-Oberhausen | Planned | Public + IM + EU | Initial Plan Study |
| 2018 | DE | Knoten Basel Bad Bf | ERTMS | ERTMS equipment existing line | Interoperability | tbd | Open | Public + IM + EU | Initial Plan Study |
| 2018 | IT | Telecomando Gallarate – Domodossola | Signalling | ACC-M | Capacity | 90 | Planned | Public | Initial Plan Study |
| 2018 | IT | Rho – Parabiago | Infrastructure | upgrade 4 tracks and link "Y" with FN | Capacity | 402 | Approved | Public | Building License |
| 2018 | IT | Scavalco di Rho | Infrastructure | Upgrade station | Capacity | 30 | Planned | Public | Initial Plan Study |
| > 2018 | DE | Border - Emmerich - Oberhausen | Infrastructure + ERTMS | 3rd track | Capacity + Interoperability | 1.700 | Approved | Public + IM + EU | Initial Plan Study |
| 2019 | CH | Basel - Bellinzona - Chiasso | Signalling | Block headway 3', node Bellinzona, incl. 750m Bellinzona+Chiasso | Capacity + Train length | 230 | Approved | Public + IM | Building License |
| 2019 | CH | Bellinzona - Lugano | Infrastructure | Ceneri Basetunnel | Capacity | 2.048 | Approved | Public + IM | Start of Construction |
| 2020 | BE | Belgian part Corridor 1 | ERTMS | ETCS | Interoperability | 153 | Approved | Public | Start of construction |

Implementation Plan RFC 1



| | | | | | | | | | |
|------|----|--|----------------|---|-----------------------------|---------------|------------------|-------------|-----------------------|
| 2020 | CH | Basel - Bellinzona - Chiasso / Ranzo | Infrastructure | Profile upgrade to 4 m | Loading Gauge | 700 | Planned | Public + IM | Building License |
| 2020 | IT | Monza | Infrastructure | Station Upgrade | Capacity | 1 | Open | Public | Initial Plan Study |
| 2020 | IT | Nodo di Genova: bretella Borzoli-succursale | Infrastructure | additional link | Capacity | 1 | Open | Public | Initial Plan Study |
| 2020 | IT | Adeguamento sagoma (linea dei Giovi) | Infrastructure | PC 45 on the line succursale between Alessandria and Bivio Bretella | Interoperability | 15 | Planned | Public | Initial Plan Study |
| 2020 | IT | Tortona - Voghera | Infrastructure | Upgrade to 4 tracks (realizzazione per fasi funzionali) | Capacity | 600 | Planned | Public + EU | Building License |
| 2020 | IT | Arquata - Genova | Infrastructure | Terzo valico (Giovi pass), 5th+6th track | Capacity | 6.200 | Planned/Approved | Public | Start of Construction |
| 2020 | IT | Corridor A/1 lines (completamento corridoio) | ERTMS | ERTMS equipment | Interoperability | to be defined | Planned | Public | Initial Plan Study |
| 2020 | IT | Domodossola - Gallarate | Infrastructure | Upgrade for 750m (Arona) | Train length | 27 | Planned | Public | Initial Plan Study |
| 2020 | IT | Gallarate - Milano | Infrastructure | Upgrade for 750m (Gallarate) | Train length | 5 | Planned | Public | Initial Plan Study |
| 2020 | IT | Luino - Laveno - Sesto Calende | Infrastructure | Upgrade 3 crossing stations for 700m | Train length | 31 | Planned | Public | Initial Plan Study |
| 2020 | IT | Luino - Laveno | Infrastructure | Nuovo punto di incrocio Luino-Laveno | Capacity + Interoperability | 15 | Planned | Public | Initial Plan Study |
| 2020 | IT | Chiasso - Milano Smistamento | Infrastructure | Upgrade power supply | Capacity | 21 | Planned | Public | Initial Plan Study |
| 2020 | IT | Chiasso - Milano Smistamento | Infrastructure | Profile upgrade to 4 m | Capacity + Interoperability | 40 | Planned | Public | Initial Plan Study |
| 2021 | BE | Gent-Sint-Pieters - Schellebelle | Infrastructure | Y-bifurcation Ledeborg & Schellebelle + Merelbeke (partial project) | Capacity | 21 | Approved | Public | Initial Plan Study |
| 2022 | BE | Zeebrugge - Brugge | Infrastructure | New hub Zwankendamme 24 tracks | Capacity | 105 | Approved | Public | Building licenece |
| 2023 | IT | Novara - Oleggio | Infrastructure | 2nd track Vignale - Oleggio | Capacity | 371 | Planned | Public | Initial Plan Study |
| 2024 | BE | Zeebrugge - Brugge | Infrastructure | 3rd track Brugge - Dudzele | Capacity | 79 | Approved | Public | Building license |
| 2025 | BE | Brugge - Gent-Sint-Pieters | Infrastructure | 3rd and 4th track Gent-Brugge | Capacity | 258 | Approved | Public | Building licence |
| 2025 | BE | Ekeren | Infrastructure | Construction Y-bifurcation Oude Landen (L27A) | Capacity | 76 | Approved | Public | Initial Plan Study |
| 2025 | BE | Mortsel | Infrastructure | Modernisation Y-bifurcation Krijgsbaan (L27A) | Capacity | 79 | Planned | Public | Initial Plan Study |
| 2025 | IT | Adeguamento P/C 60 Luino-Gallarate | Infrastructure | --> PC60 in corso di valutazione | Interoperability | 1 | Open | Public | Initial Plan Study |
| 2025 | IT | Oleggio - Arona | Infrastructure | 2nd tracks and 4meter gauge | Capacity + Interoperability | 164 | Planned | Public | Initial Plan Study |

Implementation Plan RFC 1



| | | | | | | | | | |
|--------|----|--|------------------------|---|-----------------------------|---------------|---------------------------|---------------------|--|
| 2025 | IT | Milano Rogoredo - Pieve Emanuele | Infrastructure | Upgrade to 4 tracks | Capacity | 250 | Planned | Public | Initial Plan Study |
| 2025 | IT | Iselle - Domodossola | Infrastructure | capacity improvement for 4m-trains | Capacity | 1 | Open | Public | Initial Plan Study |
| > 2025 | NL | Budel - Weert - Maasbrug - Maas - Grens Roermond/ Roerdalen - Vlodrop Gr | Infrastructure | Iron Rhine | Capacity | to be defined | Open | Negotiation ongoing | |
| > 2025 | BE | Lier - Herentals - Mol - Neerpelt - Hamont | Infrastructure | Iron Rhine | Capacity | to be defined | Open | Negotiation ongoing | |
| > 2025 | BE | Belgian part Corridor 1 | Infrastructure | Level crossing removal | Capacity | 88 | Approved | Public + EU | |
| > 2025 | DE | Border NL/D - Dalheim - Rheydt | Infrastructure | Iron Rhine | Capacity | to be defined | Open | Negotiation ongoing | |
| > 2025 | CH | Frutigen - Brig | Infrastructure | Base tunnel, 2 track, part 2 | Capacity | 640 | Open | Public + IM | Initial Plan Study |
| 2030 | IT | Chiasso - Seregno - Monza | Infrastructure | 4 tracks | Capacity | 1.412 | Planned | Public | Initial Plan Study |
| 2030 | IT | Seregno - Bergamo (-Treviglio) | Infrastructure | Gronda est | Capacity | 1.000 | Planned | Public | Building License |
| 2030 | IT | Parabiago-Gallarate | Infrastructure | upgrade 3 tracks | Capacity | 326 | Planned | Public | Initial Plan Study |
| > 2030 | IT | Laveno - Luino - Cadenazo | Infrastructure | Gronda ovest | Capacity | 1.270 | Planned | Public | |
| > 2030 | IT | Novara | Infrastructure | Node upgrade (passante) | Capacity | 503 | Planned | Public | Initial Plan Study |
| > 2030 | IT | Voghera-Treviglio via Piacenza-Cremona | Infrastructure | 2 nd track on critical section and upgrade lines Voghera-Piacenza, Piacenza-Cremona, Cremona-Treviglio | Capacity | 1.200 | Planned | Public | Open |
| open | BE | A'pen-Noord - A'pen-Berchem | Infrastructure | Port of Antwerp: 2nd rail acces to the port | Capacity | to be defined | Open | Negotiation ongoing | Initial plan study |
| open | BE | Hasselt | Infrastructure | Hasselt tracks reorganisation | Capacity | to be defined | Open | Negotiation ongoing | |
| open | DE | Karlsruhe - Offenburg | Infrastructure + ERTMS | 3rd + 4th track | Capacity Interoperability + | 2.100 | Approved / Used | Public + IM + EU | Partly start of construction / partly used |
| open | DE | Offenburg - Basel | Infrastructure + ERTMS | 3rd + 4th track | Capacity Interoperability + | 4.100 | Planned / Approved / Used | Public + IM + EU | Partly initial plan study / partly start of construction / partly used |
| open | DE | Oberhausen - Basel | ERTMS | ERTMS equipment existing line | Interoperability | to be defined | Open | Public + IM + EU | Initial Plan Study |
| open | DE | Mainz/Wiesb. - Mannheim | Infrastructure + ERTMS | HS-Line | Capacity Interoperability + | 2.200 | Planned | Public + IM + EU | Initial Plan Study |

Table 2: RFC 1 indicative investment plan

7 Interoperability

7.1 ERTMS Implementation Plan

7.1.1 Introduction

The following chapter describes the ERTMS Implementation plan of RFC 1, according to Art 11, §1(b) of the Regulation (EU) No 913/2010. RFC 1 runs from Rotterdam and Zeebrugge/ Antwerp to Genoa along the river Rhine and crossing the Alps through Switzerland until Genoa and is the most important rail transport feeder for the industrial heart of Europe.

RFC 1 is originally based on the ERTMS Corridor A according to the TSI CCS 2012/88/EU, Chapter 7, European Deployment Plan (EDP), on which the Member States involved have to implement ERTMS on the lines mentioned until the end of 2015 or 2020 as defined there. In opposition to this, no implementation deadline is defined in the Regulation (EU) No 913/2010 for the RFC 1.

Therefore, the following ERTMS Implementation plan is divided into 2 chapters:

- 7.1.5 ERTMS Implementation with Reference to TSI CCS (EDP) and
- 7.1.6 ERTMS Implementation with Reference to Regulation (EU) No 913/2010

To prepare for the growing demand in the market and to offer the best quality for competitive rail freight services, the establishment of interoperability through a common European train control system is a paramount prerequisite. Subsequently, the implementation of ERTMS is part of the European policy, the TEN-T guidelines, for the RFC 1 the Regulation (EU) No 913/2010 and for the ERTMS Corridor A the TSI CCS 2012/88/EU, Chapter 7, European Deployment Plan (EDP).

Due to the fact that RFC 1 resp. ERTMS Corridor A is an early implementer of ERTMS on an international level, work on fundamental issues of interoperability and cross acceptance for an economic and smooth placing into service present a vital challenge. The specific national conditions as well as the availability of funds have to be respected in the preparation of a sound migration concept across the borders. This involves, operational and engineering rules, system functionalities, system performance and quality of service, life cycle of existing signalling systems and line parameters, as well as a common concept for purchasing, installing, testing and accepting works which have to be analysed in detail, coordinated and harmonised as far as possible among all parties.

In RFC 1 respectively ERTMS Corridor A, the starting positions for ERTMS deployment in each country is very different due to the following facts:

- ⇒ In the Netherlands, the Betuwe line is a new line dedicated only to freight trains and equipped with ETCS. No class B systems are available which makes it indispensable that a vehicle is ERTMS-equipped.
- ⇒ In Belgium, the outlined ERTMS implementation of the corridor lines is part of a country wide migration concept and triggered by the need for substitution of class B systems. Although Belgium is not obliged by the European Deployment Plan to finalise ERTMS on the corridor lines in 2015, it is the strong intention to equip this corridor as soon as possible. Furthermore according to chapter 7.3.2.2 & 7.3.5 of the TSI CCS (Decision 2012/88/EU) linking Gent and Zeebrugge to at least one of the six corridors specified in chapter 7.3.4 by 2020, in casu Corridor A, is mandatory.
- ⇒ In Germany, DB Netz has provided information regarding the Corridor A lines pursuant to the TSI CCS, chapter 7, European Deployment Plan (EDP). No planning is available regarding the RFC 1 lines that are not part of the EDP (chapter 7.1.6.3.1 Description of Corridor Lines).

The Corridor A lines in Germany are mixed traffic lines. Furthermore, the existing class B systems PZB and LZB are fully operational for many more years. The implementation of ERTMS means an additional investment and the parallel operation and maintenance of the national ATC systems and ERTMS. In addition, the German corridor lines are highly used and the deployment of ERTMS has at least to provide the same capacity and performance as the class B systems.

- This can only be achieved by deploying in some sections ERTMS Level 2 with the consequence that existing interlockings in good order may also to be replaced by electronic equipment.
 - An economical concept for implementation of ERTMS has to respect all these circumstances and this is very difficult to achieve. Subsequently, the considerations for implementing ERTMS could not yet be finalised by the German Ministry of Transport.
- ⇒ In Switzerland, the successful operation of ERTMS in Level 2 has already been well proved since years on the HSL line from Rothrist to Mattstetten, as well as on the Lötschberg base tunnel line. In view of the need for general substitution of the existing class B systems ZUB and Signum, SBB and BLS have developed an economical migration concept based on the deployment of the ETCS mode Level 1 Limited Supervision (LS). This concept substitutes class B system without limiting operation of existing national vehicles and allowing the use of vehicles equipped with ERTMS at the same time. Besides this, Switzerland has already completed major investments for equipping their fleet with ERTMS.
- ⇒ In Italy, the successful operation of ERTMS in Level 2 has already been well proved since years on the HSL network, connecting Torino – Milano – Bologna – Firenze and Roma – Napoli. For the conventional lines during the last years major investments had just been made for the upgrading of the class B system into SCMT, which is based on the use of balises thus presenting a good basis for the implementation of ERTMS. The corridor lines will be mixed level lines with ERTMS and the existing class B system. To define the complete operational scenario, technical implications about the ERTMS level (Level 2/Level 1) and the Baseline (B2/B3) have to be accounted for and need to be tested before defining the final deployment strategy and starting a major roll out on the corridor lines. Subsequently, a pilot installation will soon be implemented.

Another basic constraint is the raising of the necessary funds for ERTMS implementation in each country.

All these above mentioned aspects, which are fully justified, make it very difficult to establish a thorough and coordinated ERTMS corridor implementation, providing the expected technical, operational and synchronised interoperability across all countries.

Considering the impact for railway undertakings, in 2008 the infrastructure managers of ERTMS Corridor A jointly decided to equip the corridor lines as much as possible with elements of the system requirement specification (SRS) Baseline no. 3, which is available only from the end of 2012, in order to provide track side highest performance and compatibility from the most advanced ERTMS standard as well as to reduce the need for future system upgrades track side and on board to a minimum. Nevertheless, the corresponding test specifications are still outstanding and there are already several change requests to Baseline 3.

The today existing ERTMS trackside installations in Europe are mostly implemented and managed by one infrastructure manager without crossing borders. On RFC 1, ERTMS will be applied and operated internationally, including border crossing. However, the installation and authorisation of the trackside part is still in the hands of each Member State. The currently available ERTMS specifications, testing campaigns and facilities, product developments as well as authorisation rules have not largely been

proven on an international corridor implementation, in particular with ERTMS installations on both sides of the border. This interaction is much more complex due to the different national aspects, national technical requirements and different operational rules.

The ERTMS on-board installations, however, have to comply with all specified ERTMS functions and all used trackside installations. Since not all ERTMS functions will be implemented in each Member State, it will be impossible to finalise track train system validation for all ERTMS system functionalities. An economical, iterative process is needed until the point is reached, where the maturity of ERTMS on board and trackside allows common simple implementations, especially for unrestricted authorisation of vehicles.

In order to support the railway undertakings and infrastructure managers to cope with the current difficult situation, the National Safety Authorities of RFC 1 have set up a working group in 2008. In cooperation with ERA and other stakeholders, this working group is preparing a guideline of recommendations for a streamlined and harmonised authorisation process. Although the focus of the work is on-board authorisation, the guideline shows the overall process for both on-board and trackside. It describes the different processes and steps of on-board and track side authorisation with the aim to reduce test and authorisation efforts and increase the part of cross acceptance step by step until the final target situation has been reached.

As soon as this guideline is completed and accepted by the Corridor NSAs, it will be available on the corridor internet webpage.

The up-to-date planned overall RFC 1 resp. Corridor A ERTMS implementation is reflected in Figure 30. It shows the corridor sections with their planned completion dates, baselines, ERTMS levels, class B systems, as well as the time frame of the parallel operation of class B systems and ERTMS. More detailed information is given in the following chapters of each country.

7.1.2 Description of Sections to be Equipped with ERTMS

Technical standards, baseline, levels

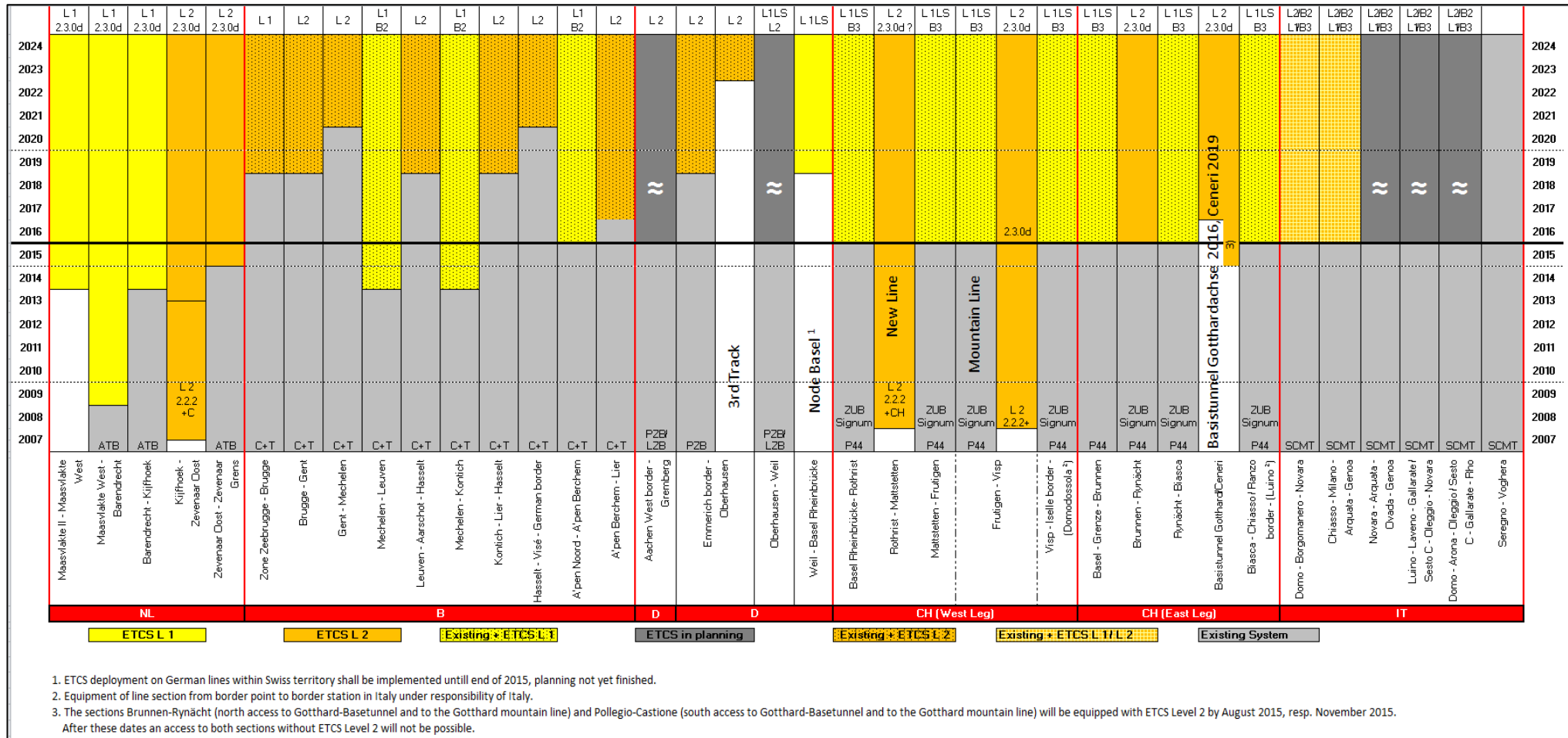

Figure 30: Corridor sections (consolidated) according to the definition of RFC 1

More details are shown in the national figures in the following chapters of national ERTMS presentation.

The present Implementation Plan ERTMS is a display of an equipping option and is subject to financing agreements. In Germany only the Corridor A projects Emmerich – Oberhausen and node Basel are secured by a financing agreement.

The legend below displays in detail the different ETCS deployment deadlines of the corridor lines reflected in the following national maps. The relevant descriptions for every country are displayed individually within each map.

| ETCS L1 deployment on corridor lines | ETCS L2 deployment on corridor lines | ETCS deployment on corridor lines, level not clear | Legend corridor lines |
|--|---|---|---|
| <ul style="list-style-type: none"> ETCS L1 LS existing lines ETCS L1 FS existing lines ETCS L1 LS till 2015 ETCS L1 FS till 2015 ETCS L1 LS till 2018 ETCS L1 FS till 2018 ETCS L1 LS till 2020 ETCS L1 FS till 2020 ETCS L1 LS later than 2020 ETCS L1 FS later than 2020 ETCS L1 LS } planning deadline ETCS L1 FS } not confirmed | <ul style="list-style-type: none"> ETCS L2 existing lines ETCS L2 till 2015 ETCS L2 till 2018 ETCS L2 till 2020 ETCS L2 later than 2020 ETCS L2 planning deadline not confirmed | <ul style="list-style-type: none"> ETCS till 2015 ETCS till 2018 ETCS till 2020 ETCS later than 2020 ETCS planning deadline not confirmed | <p>Legend corridor lines</p> <ul style="list-style-type: none"> RFC 1 lines without actual ETCS planning (EDP or non EDP) Expected line w-w/o ETCS planning Private lines Railway node or junction* State border Cross-border line section Border point (state border or between national Intra-structure Managers) <p>* BE = Y / DE = Abzw.</p> <p>Legend Terminals</p> <ul style="list-style-type: none"> Loading/unloading facilities Marshalling Yard Other stations for train formation, shunting, operational hand over |

Table 3: General legend of maps showing ERTMS deployment on RFC 1

7.1.3 Description of ERTMS Sections with Reference to TSI CCS (Corridor A)

Figure 31 and Table 4 show the corridor lines, for which the Corridor A Member States are planning to implement ERTMS as it is defined in the TSI CCS, Chapter 7, European Deployment Plan (EDP) and the status of current and planned installation. As Switzerland is also part of the Letter of Intent (LOI) the Swiss ERTMS lines are also included.

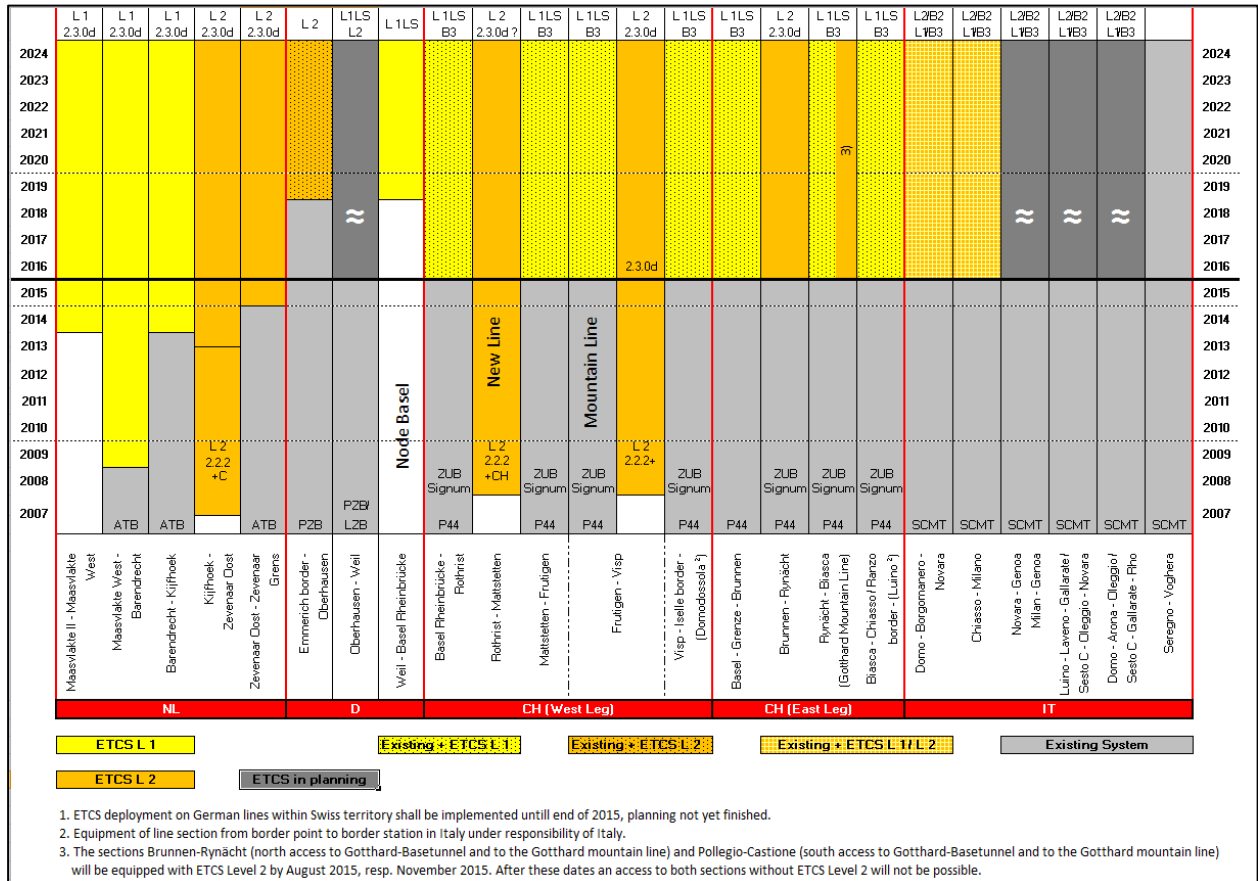

Figure 31: Corridor sections to be equipped with ERTMS according to TSI CCS

Remark: The present ERTMS implementation plan is a display of an equipping option and is subject to financing agreements. In Germany only the Corridor A projects Emmerich – Oberhausen and node Basel are secured by a financing agreement.

| Line Type | Basis for ERTMS | IM | line no. | from (name of location) | to (name of location) |
|-----------|-----------------|---------|----------|-------------------------|-----------------------|
| Principal | EDP | ProRail | | Maasvlakte West/Oost | Waalhaven Zuid |
| Principal | EDP | ProRail | | Waalhaven Zuid | Barendrecht |
| Principal | EDP | ProRail | | Barendrecht | Kijfhoek |
| Principal | EDP | ProRail | | Kijfhoek | Meteren |
| Principal | EDP | ProRail | | Meteren | Zevenaar Oost |
| Principal | EDP | ProRail | | Zevenaar Oost | Zevenaar Grens |
| Principal | EDP | ProRail | | Amsterdam | Utrecht |
| Principal | EDP | ProRail | | Utrecht | Meteren |
| Principal | EDP | DB Netz | 2270 | Emmerich Grenze | Emmerich |
| Principal | EDP | DB Netz | 2270 | Emmerich | Wesel |
| Principal | EDP | DB Netz | 2270 | Wesel | Oberhausen-Sterkrade |
| Principal | EDP | DB Netz | 2271 | Oberhausen Hbf Obn | Oberhausen Hbf Obn |
| Principal | EDP | DB Netz | 2320 | Oberhausen West Oro | Duisburg Ruhrtal |
| Principal | EDP | DB Netz | 2320 | Duisburg Ruhrtal | Duisburg Sigle |

| | | | | | |
|--------------|-----|---------|------|----------------------------------|----------------------------------|
| Principal | EDP | DB Netz | 2323 | Duisburg Sigle | Duisburg Lotharstrasse |
| Connecting A | EDP | DB Netz | 2323 | Duisburg Lotharstrasse | Duisburg Hochfeld Süd |
| Connecting A | EDP | DB Netz | 2327 | Duisburg Ruhrort Hafen | Abzw. Mathilde |
| Connecting A | EDP | DB Netz | 2302 | Duisburg Ruhrort Hafen | Oberhausen West |
| Connecting A | EDP | DB Netz | 2307 | Duisburg Ruhrtal | Duisburg Ruhrort Hafen |
| Principal | EDP | DB Netz | 2321 | Oberhausen Hbf Obn | Oberhausen West Oro |
| Principal | EDP | DB Netz | 2321 | Oberhausen West Oro | Abzw Mathilde |
| Principal | EDP | DB Netz | 2321 | Abzw Mathilde | Abzw Ruhrtal |
| Principal | EDP | DB Netz | 2321 | Abzw Ruhrtal | Abzw Lotharstraße |
| Principal | EDP | DB Netz | 2321 | Abzw Lotharstraße | Duisburg-Wedau |
| Principal | EDP | DB Netz | 2324 | Duisburg-Wedau | Köln-Kalk Einf |
| Principal | EDP | DB Netz | 2324 | Köln-Kalk Einf | Köln Kalk Nord Ksf |
| Principal | EDP | DB Netz | 2324 | Köln Kalk Nord Ksf | Abzw Gremberg Nord |
| Principal | EDP | DB Netz | 2324 | Abzw Gremberg Nord | Gremberg Pers.-Wechselstation |
| Principal | EDP | DB Netz | 2324 | Gremberg Pers.-Wechselstation | Abzw Gremberg Süd |
| Principal | EDP | DB Netz | 2324 | Abzw Gremberg Süd | Troisdorf |
| Principal | EDP | DB Netz | 2324 | Troisdorf | Linz (Rh) |
| Principal | EDP | DB Netz | 2324 | Linz (Rh) | Neuwied Gbf |
| Principal | EDP | DB Netz | 2324 | Neuwied Gbf | Abzw Koblenz-Pfaffendorf |
| | | | | | |
| Connecting A | EDP | DB Netz | 2665 | Köln Kalk Nord Einfahrt | Köln Kalk Nord Km |
| Connecting A | EDP | DB Netz | 2667 | Köln Kalk Nord Km | Köln Kalk Nord Ksf |
| Connecting A | EDP | DB Netz | 2669 | Köln Kalk Nord Knf | Köln Kalk Nord Kw |
| Connecting A | EDP | DB Netz | 2666 | Köln Kalk Nord Ksf | Gremberg Gsf |
| | | | | | |
| Principal | EDP | DB Netz | 2324 | Abzw Koblenz-Pfaffendorf | StrWe 2324/3507 |
| Principal | EDP | DB Netz | 3507 | StrWe 2324/3507 | Niederlahnstein |
| Principal | EDP | DB Netz | 3507 | Niederlahnstein | Oberlahnstein Gbf |
| Principal | EDP | DB Netz | 3507 | Oberlahnstein Gbf | Rüdesheim (Rh) |
| Principal | EDP | DB Netz | 3507 | Rüdesheim (Rh) | Wiesbaden-Schierstein |
| Principal | EDP | DB Netz | 3507 | Wiesbaden-Schierstein | Wiesbaden-Biebrich Ültg |
| Principal | EDP | DB Netz | 3507 | Wiesbaden-Biebrich Ültg | Wiesbaden Ost Gbf |
| Principal | EDP | DB Netz | 3507 | Wiesbaden Ost Gbf | Wiesbaden Ost Gbf Ültg (B) |
| Principal | EDP | DB Netz | 3603 | Wiesbaden Ost Gbf Ültg (B) | Mainz-Kastel |
| Principal | EDP | DB Netz | 3603 | Mainz-Kastel | Abzw Kostheim |
| Principal | EDP | DB Netz | 3531 | Abzw Kostheim | Abzw Kostheim Ost |
| Principal | EDP | DB Netz | 3525 | Abzw Kostheim | Mainz-Bischofsheim Pbf |
| Principal | EDP | DB Netz | 3525 | Mainz-Bischofsheim Pbf | Mainz-Bischofsheim Gbf |
| Principal | EDP | DB Netz | 3525 | Mainz-Bischofsheim Gbf | Bft Mainz-Bischofsheim Ültg I |
| Principal | EDP | DB Netz | 3530 | Mainz-Bischofsheim Ültg | Groß Gerau |
| Principal | EDP | DB Netz | 3530 | Groß Gerau | Abzw Stockschnoise |
| Principal | EDP | DB Netz | 3530 | Abzw Stockschnoise | Darmstadt Hbf |
| Principal | EDP | DB Netz | 3537 | Abzw Stockschnoise | Darmstadt Hbf |
| Principal | EDP | DB Netz | 3601 | Darmstadt Hbf | Darmstadt-Eberstadt |
| Principal | EDP | DB Netz | 3601 | Darmstadt-Eberstadt | Weinheim (Bergstr) |
| Principal | EDP | DB Netz | 3601 | Weinheim (Bergstr) | Mannheim-Friedrichsfeld |
| Principal | EDP | DB Netz | 4060 | Mannheim-Friedrichsfeld | Mannheim Ziehbrunnen |
| Principal | EDP | DB Netz | 4060 | Abzw Ziehbrunnen | Schwetzingen |
| Connecting A | EDP | DB Netz | 4061 | Mannheim-Friedrichsfeld | Mannheim- Friedrie. Südeinf/Ausf |
| Connecting A | EDP | DB Netz | 4062 | Mannheim-Friedrichsfeld | Mannheim- Friedrie. Südeinf/Ausf |
| Connecting A | EDP | DB Netz | 4050 | Mannheim- Friedrie. Südeinf/Ausf | Mannheim Rbf Westeinfahrt |
| Connecting A | EDP | DB Netz | 4002 | Mannheim-Friedrie. Südeinf/Ausf | Mannheim Hbf Ost |
| Connecting A | EDP | DB Netz | 4021 | Mannheim Rbf Gr E | Abzw Mannheim-Neckarau |
| Connecting A | EDP | DB Netz | 4020 | Abzw Mannheim-Neckarau | Schwetzingen |
| Connecting A | EDP | DB Netz | 4052 | Mannheim Rbf Gr E | Mannheim Ziehbrunnen |
| Principal | EDP | DB Netz | 4020 | Schwetzingen | Hockenheim |
| Principal | EDP | DB Netz | 4020 | Hockenheim | Abzw Molzau |
| Principal | EDP | DB Netz | 4020 | Graben-Neudorf | Karlsruhe-Hagsfeld |
| Principal | EDP | DB Netz | 4020 | Karlsruhe-Dammerstock | Rastatt |
| Principal | EDP | DB Netz | 4210 | Karlsruhe-Hagsfeld | Karlsruhe Gbf |
| Principal | EDP | DB Netz | 4213 | Karlsruhe Gbf | Abzw Brunnenstück |
| Principal | EDP | DB Netz | 4214 | Karlsruhe Gbf | Ka-Dammerstock |

| | | | | | |
|-------------|-----|-----------|---------|--------------------------|--------------------------|
| Principal | EDP | DB Netz | 4280 | Abzw Rastatt Süd | Appenweier |
| Principal | EDP | DB Netz | 4280 | Appenweier | Appenweier Muhrhaag |
| Principal | EDP | DB Netz | 4280 | Appenweier Muhrhaag | Offenburg |
| Principal | EDP | DB Netz | 4280 | Offenburg | Offenburg Süd |
| Principal | EDP | DB Netz | 4280 | Abzw Schliengen Nord | Eimeldingen |
| Principal | EDP | DB Netz | 4263 | Abzw Windschläg | Offenburg Gbf Gruppe A |
| Principal | EDP | DB Netz | 4263 | Offenburg Gbf Gruppe A | Offenburg |
| Principal | EDP | DB Netz | 4263 | Offenburg | Offenburg Süd |
| Principal | EDP | DB Netz | 4312 | Abzw Gundelfingen | Freiburg Gbf |
| Principal | EDP | DB Netz | 4312 | Freiburg Gbf | Abzw Leutersberg |
| | | | | | |
| Principal | EDP | DB Netz | 4000 | Karlsruhe Hbf | Abzw Brunnenstück |
| Principal | EDP | DB Netz | 4000 | Abzw Brunnenstück | Ettlingen West |
| Principal | EDP | DB Netz | 4000 | Ettlingen West | Rastatt |
| Principal | EDP | DB Netz | 4000 | Rastatt | Abzw Rastatt Süd |
| Principal | EDP | DB Netz | 4000 | Abzw Rastatt Süd | Appenweier |
| Principal | EDP | DB Netz | 4000 | Appenweier | Appenweier Muhrhaag |
| Principal | EDP | DB Netz | 4000 | Appenweier Muhrhaag | Abzw Windschläg |
| Principal | EDP | DB Netz | 4000 | Abzw Windschläg | Offenburg |
| Principal | EDP | DB Netz | 4000 | Offenburg | Offenburg Süd |
| Principal | EDP | DB Netz | 4000 | Offenburg Süd | Kenzingen |
| Principal | EDP | DB Netz | 4000 | Kenzingen | Abzw Gundelfingen |
| Principal | EDP | DB Netz | 4000 | Abzw Gundelfingen | Freiburg Hbf |
| Principal | EDP | DB Netz | 4000 | Freiburg Hbf | Abzw Leutersberg |
| Principal | EDP | DB Netz | 4000 | Abzw Leutersberg | Müllheim |
| Principal | EDP | DB Netz | 4000 | Müllheim | Abzw Schliengen Nord |
| Principal | EDP | DB Netz | 4000 | Abzw Schliengen Nord | Haltingen |
| Principal | EDP | DB Netz | 4000 | Haltingen | Weil am Rhein |
| Principal | EDP | DB Netz | 4000 | Weil am Rhein | Weil am Rhein BW/CH |
| Principal | EDP | DB Netz | 4000 | Weil am Rhein BW/CH | Basel Bad Bf |
| Principal | EDP | DB Netz | 4411 | Weil am Rhein | Basel Bad Rbf (Gr. A) |
| Principal | EDP | DB Netz | 4413 | Haltingen | Basel Bad Rbf (Gr. C) |
| Principal | EDP | DB Netz | 4415 | Weil am Rhein | Basel Bad Rbf (Gr. A) |
| Principal | EDP | DB Netz | 4404 | Basel Bad Bf | Basel Grenze |
| Principal | EDP | DB Netz | 4405 | Basel Bad Rbf (Gr. C) | Basel Bad Rbf BW/CH 4405 |
| Principal | EDP | DB Netz | 4405 | Basel Bad Rbf BW/CH 4405 | Gellert |
| Principal | EDP | DB Netz | 4407 | Gellert | Basel Grenze Muttenz |
| | | | | | |
| Principal | EDP | DB Netz | 4082 | Abzw Molzau | Graben-Neudorf |
| Principal | EDP | DB Netz | 4020 | Karlsruhe-Hagsfeld | Karlsruhe Hbf |
| Principal | EDP | DB Netz | 4020 | Karlsruhe Hbf | Abzw Dammerstock |
| Principal | EDP | DB Netz | 4214 | Karlsruhe Gbf | Abzw Dammerstock |
| Principal | EDP | DB Netz | 4020 | Abzw Dammerstock | Durmersheim |
| Principal | EDP | DB Netz | 4020 | Durmersheim | Rastatt |
| | | | | | |
| Principal | LOI | SBB Infra | 700 | Gellert | Basel SBB RB |
| Principal | LOI | SBB Infra | 700 | Basel SBB RB | Pratteln |
| | | | | | |
| Divisionary | LOI | SBB Infra | 500 | Muttenz | Liestal via Adlertunnel |
| Divisionary | LOI | SBB Infra | 500 | Pratteln | Olten VL |
| Divisionary | LOI | SBB Infra | 550/650 | Olten VL | Ruppertswil |
| Divisionary | LOI | SBB Infra | 653 | Ruppertswil | Henschiken |
| | | | | | |
| Principal | LOI | SBB Infra | 500 | Pratteln | Olten |
| Principal | LOI | SBB Infra | 450 | Olten | Rothrist |
| Principal | LOI | SBB Infra | 450 | Rothrist | Mattstetten via NBS |
| Principal | LOI | SBB Infra | | Rothrist | Mattstetten via Burgdorf |
| Principal | LOI | SBB Infra | 450 | Mattstetten | Bern VL |
| Principal | LOI | SBB Infra | 290 | Bern VL | Thun |
| | | | | | |
| Principal | LOI | SBB Infra | 700 | Pratteln | Brugg VL |
| Principal | LOI | SBB Infra | 654 | Brugg VL | Henschiken |

| | | | | | |
|--------------|------|-----------|-------|----------------------|-------------------------|
| Principal | LOI | SBB Infra | 653 | Hendschiken | Arth-Goldau |
| Principal | LOI | SBB Infra | 600 | Arth-Goldau | Giubiasco |
| Principal | LOI | SBB Infra | 631 | Giubiasco | Pino Tronzano (Luino) |
| Principal | LOI | SBB Infra | 600 | Giubiasco | Balerna |
| Principal | LOI | SBB Infra | | Balerna | Chiasso SM / Chiasso Vg |
| | | | | | |
| Principal | LOI | SBB Infra | 310 | Thun | Thun Scherzlingen |
| Principal | LOI | BLS Infra | 310 | Thun Scherzlingen | Spiez |
| Principal | LOI | BLS Infra | 300 | Spiez | Wengi-Ey |
| | | | | | |
| Principal | LOI | BLS Infra | 300 | Wengi-Ey | Frutigen |
| Principal | LOI | BLS Infra | 300 | Frutigen | Abzw. Brig |
| | | | | | |
| Principal | LOI | BLS Infra | 330 | Wengi-Ey | St. German |
| Principal | LOI | SBB Infra | 100 | St. German | Abzw. Brig |
| | | | | | |
| Principal | LOI | SBB Infra | 100 | Abzw. Brig | Brig |
| Principal | LOI | SBB Infra | 100 | Brig | Confine CH-I |
| Principal | LOI | SBB Infra | 100 | Confine CH-I | Portal Nord Sempioncino |
| | | | | | |
| Principal | EDP | RFI | | Confine CH-IT | Iselle |
| Principal | EDP | RFI | | Iselle | Domodossola |
| Connecting A | EDP | RFI | 1000 | Domodossola | Bivio Toce |
| Connecting A | (*) | RFI | 1000 | Bivio Toce | Domo II |
| Connecting A | (*) | RFI | 1000 | Domo II | Bivio Valle |
| | | | | | |
| Diversionary | (**) | RFI | 1000 | Domodossola | Pieve Vergonte |
| Diversionary | (**) | RFI | 1000 | Pieve Vergonte | Premossello |
| | | | | | |
| Principal | EDP | RFI | 3540 | Domodossola | Premossello |
| Diversionary | EDP | RFI | 31621 | Premossello | Caltignaga |
| Diversionary | EDP | RFI | 31620 | Caltignaga | Vignale |
| | | | | | |
| Principal | EDP | RFI | 390 | Premossello | Arona |
| Principal | EDP | RFI | 32630 | Arona | Oleggio |
| Principal | EDP | RFI | 32584 | Oleggio | Vignale |
| | | | | | |
| Principal | EDP | RFI | 31270 | Vignale | Novara |
| Connecting A | EDP | RFI | 1000 | Novara | Novara Boschetto |
| Principal | EDP | RFI | 341 | Novara | Mortara |
| Connecting A | EDP | RFI | 1000 | Mortara | Mortara Smistamento |
| Principal | EDP | RFI | 341 | Mortara | Torreberetti |
| Principal | EDP | RFI | 342 | Torreberetti | Valenza |
| Principal | EDP | RFI | 343 | Valenza | Alessandria |
| Principal | EDP | RFI | 32562 | Alessandria | Ovada |
| Principal | EDP | RFI | 32561 | Ovada | Genova Borzoli |
| Connecting A | (*) | RFI | 31923 | Genova Borzoli | Genova Voltri Mare |
| Principal | EDP | RFI | 32561 | Genova Borzoli | B. Polcevera |
| Principal | EDP | RFI | 32561 | B. Polcevera | Genova Sampierdarena |
| Connecting A | (*) | RFI | 32561 | Genova Sampierdarena | Genova Marittima |
| | | | | | |
| Principal | EDP | RFI | 330 | Alessandria | Frugarolo |
| Principal | EDP | RFI | 3751 | Frugarolo | Novi Ligure |
| Principal | EDP | RFI | 3752 | Novi Ligure | Arquata Scrivia |
| | | | | | |
| Principal | EDP | RFI | 31165 | Chiasso | Bivio Rosales |
| | | | | | |
| Principal | EDP | RFI | 31161 | Chiasso | Como S. Giovanni |
| Principal | EDP | RFI | 31162 | Como S. Giovanni | Albate Camerlata |
| Principal | EDP | RFI | 31163 | Albate Camerlata | Bivio Rosales |
| Principal | EDP | RFI | 31164 | Bivio Rosales | Seregno |
| Principal | EDP | RFI | 31169 | Seregno | Monza |

| | | | | | |
|--------------|-----|-----|-------|-------------------|----------------------|
| | | | | | |
| Principal | EDP | RFI | 31171 | Monza | Milano Lambrate |
| Connecting A | (*) | RFI | 31171 | Milano Lambrate | Milano Smistamento |
| Principal | EDP | RFI | 1000 | Milano Lambrate | Milano Regeredo |
| Principal | EDP | RFI | 32401 | Milano Rogoredo | Pavia |
| Principal | EDP | RFI | 32402 | Pavia | Bressana |
| Principal | EDP | RFI | 32403 | Bressana | Voghera |
| Principal | EDP | RFI | 32130 | Voghera | Tortona |
| Principal | EDP | RFI | 3110 | Tortona | Arquata Scrivia |
| Principal | EDP | RFI | 31770 | Arquata Scrivia | Ronco Scrivia |
| Principal | EDP | RFI | 32780 | Ronco Scrivia | Bivio / PC Fegino |
| Principal | EDP | RFI | 31923 | Bivio / PC Fegino | Genova Sanpierdarena |
| | | | | | |
| Connecting A | EDP | RFI | 32750 | Milano Lambrate | Melzo Scalo |
| | | | | | |
| Connecting A | EDP | RFI | 3771 | Arona | Sesto Calende |
| Connecting A | EDP | RFI | 3772 | Sesto Calende | Gallarate |
| Connecting A | EDP | RFI | 31701 | Gallarate | Busto Arsizio |
| Connecting A | EDP | RFI | 31702 | Busto Arsizio | Rho |
| Connecting A | EDP | RFI | 31130 | Rho | Milano Certosa |
| Connecting A | (*) | RFI | 1000 | Milano Certosa | Milano Lambrate |
| | | | | | |
| Connecting A | EDP | RFI | 32581 | Luino | Laveno |
| Connecting A | EDP | RFI | 32590 | Laveno | Gallarate |
| | | | | | |
| Connecting A | EDP | RFI | 32582 | Laveno | Sesto Calende |
| Connecting A | EDP | RFI | 32583 | Sesto Calende | Oleggio |
| | | | | | |
| Connecting A | EDP | RFI | 241 | Voghera | Piacenza |
| Connecting A | EDP | RFI | 31052 | Piacenza | Milano Rogoredo |

Table 4: ERTMS sections with reference to TSI CCS

(*) the routing within the major nodes in Italy is still to be defined

(**) not detailed in EDP

7.1.4 Description of RFC 1 ERTMS Sections According to the Regulation (EU) No 913/2010

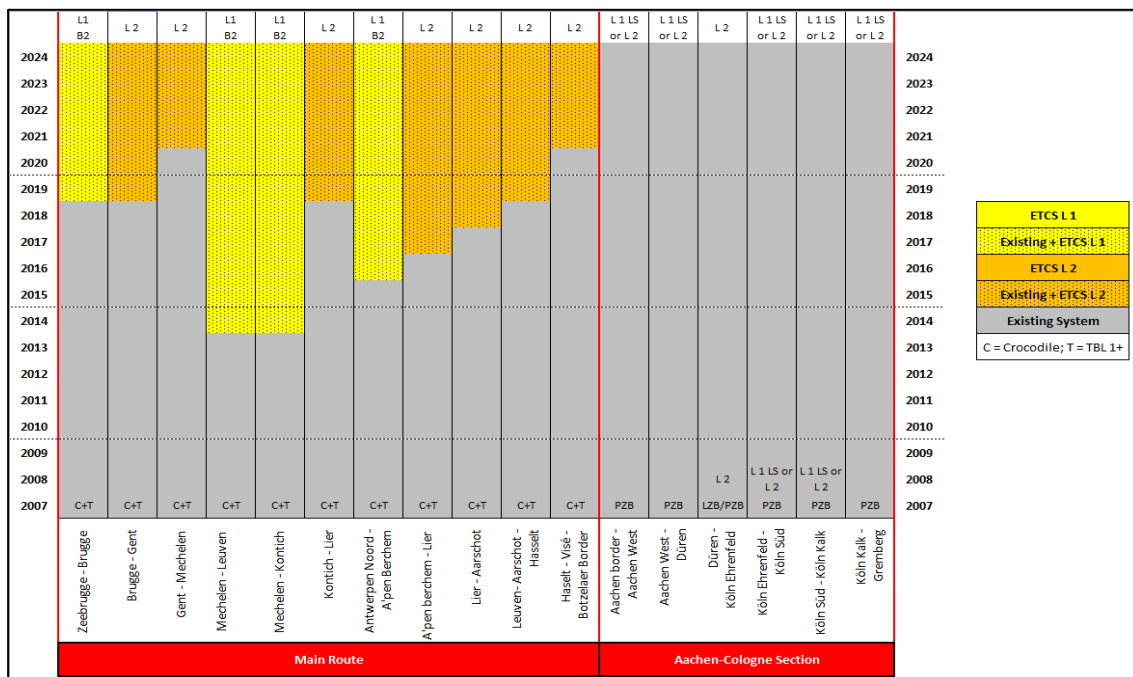

Figure 32: Corridor sections to be equipped with ERTMS according Regulation (EU) No 913/2010

Table 5 shows RFC 1 lines, that do not belong to the European Deployment Plan, but for which the RFC 1 Member States are obliged to publish a deployment according to the Regulation (EU) No 913/2010.

| Line Type | IM | line no. | from (name of location) | to (name of location) |
|-----------|----------|----------|------------------------------|------------------------------|
| Principal | Infrabel | L51A | Zeebrugge Vorming | Y Blauwe Toren |
| Principal | Infrabel | L51 | Y Blauwe Toren | Brugge |
| Principal | Infrabel | L50A | Brugge | Gent St. Pieters |
| Principal | Infrabel | L50 | Gent St. Pieters | Y .West Driehoek Ledeborg |
| Principal | Infrabel | L50 | Y .West Driehoek Ledeborg | Y.Oost Driehoek Ledeborg |
| Principal | Infrabel | L50 | Y.Oost Driehoek Ledeborg | Y Melle |
| Principal | Infrabel | L50 | Y Melle | Schellebelle |
| Principal | Infrabel | L53 | Schellebelle | Dendermonde |
| Principal | Infrabel | L53 | Dendermonde | Mechelen |
| Principal | Infrabel | L53 | Mechelen | Y Muizen |
| Principal | Infrabel | L53 | Y Muizen | Muizen Rooster T |
| Principal | Infrabel | L53 | Muizen Rooster T | Y Dyleburg |
| Principal | Infrabel | L53/1 | Y Dylebrug | Y.Holsbeek |
| Principal | Infrabel | L35 | Y.Holsbeek | Y. Zuid Driehoek Aarschot |
| Principal | Infrabel | L35 | Y. Zuid Driehoek Aarschot | Y. Oost Driehoek Aarschot |
| Principal | Infrabel | L35 | Y. Oost Driehoek Aarschot | Hasselt |
| | | | | |
| Principal | Infrabel | L10 | Antwerpen-Kallo | Y Kattestraat |
| Principal | Infrabel | L10/2 | Y Kattestraat | Y Zwindrecht-Fort |
| Principal | Infrabel | L59 | Y Zwindrecht-Fort | Antwerpen-Berchem |
| | | | | |
| Principal | Infrabel | L27 | Mechelen | Y Duffel |
| Principal | Infrabel | L13/1 | Y Duffel | Y Lint |
| Principal | Infrabel | L13 | Y Lint | Lier |
| | | | | |
| Principal | Infrabel | L27A | Antwerpen Noord Inrit C1 | Antwerpen Schijnpoort |
| Principal | Infrabel | L27A | Antwerpen Schijnpoort | Antwerpen-Berchem |
| Principal | Infrabel | L27A | Antwerpen-Berchem | Y.Krijgsbaan |
| Principal | Infrabel | L15/1 | Y.Krijgsbaan | Y Aubry |
| Principal | Infrabel | L15 | Y Aubry | Lier |
| Principal | Infrabel | L15 | Lier | Y Nazareth |
| Principal | Infrabel | L16 | Y Nazareth | Nieuwe Y. Noord Dr. Aarschot |
| Principal | Infrabel | L35 | Nieuwe Y. Noord Dr. Aarschot | Y. Oost Driehoek Aarschot |
| Principal | Infrabel | L35 | Y. Oost Driehoek Aarschot | Hasselt |
| | | | | |
| Principal | Infrabel | L34 | Hasselt | Bilzen |
| Principal | Infrabel | L34 | Bilzen | Y Glons |
| Principal | Infrabel | L24 | Y Glons | Y Berneau |
| Principal | Infrabel | L24 | Y Berneau | Montzen - Block 15 |
| Principal | Infrabel | L24 | Montzen - Block 15 | Montzen border (Botzelaer) |
| | | | | |
| Principal | DB Netz | 2552 | Aachen West Grenze | Aachen West Gbf |
| Principal | DB Netz | 2553 | Aachen West Westkopf | Aachen West Pbf |
| Principal | DB Netz | 2550 | Aachen West Gbf | Aachen Hbf |
| Principal | DB Netz | 2600 | Aachen Hbf | Düren Pbf |
| Principal | DB Netz | 2600 | Düren Pbf | Köln-Ehrenfeld Gbf |
| Principal | DB Netz | 2613 | Köln-Ehrenfeld Gbf | Köln West Wf |
| Principal | DB Netz | 2613 | Köln West Wf | Köln West Ws |
| Principal | DB Netz | 2640 | Köln West Ws | Abzw Köln Süd |
| Principal | DB Netz | 2641 | Abzw Köln Süd | Köln Südbrücke Abzw |
| Principal | DB Netz | 2656 | Köln Südbrücke Abzw | Abzw Gremberg Nord |

Table 5: ERTMS sections according to the Regulation (EU) No 913/2010

7.1.5 ERTMS Implementation with Reference to TSI CCS (EDP)

7.1.5.1 The Netherlands

7.1.5.1.1 Description of Corridor Lines

The Dutch parts of the Corridor to be equipped with ETCS in the frame of the EDP are the dedicated freight line, called the Betuweline (until 2015) and the link to Amsterdam (until 2020).

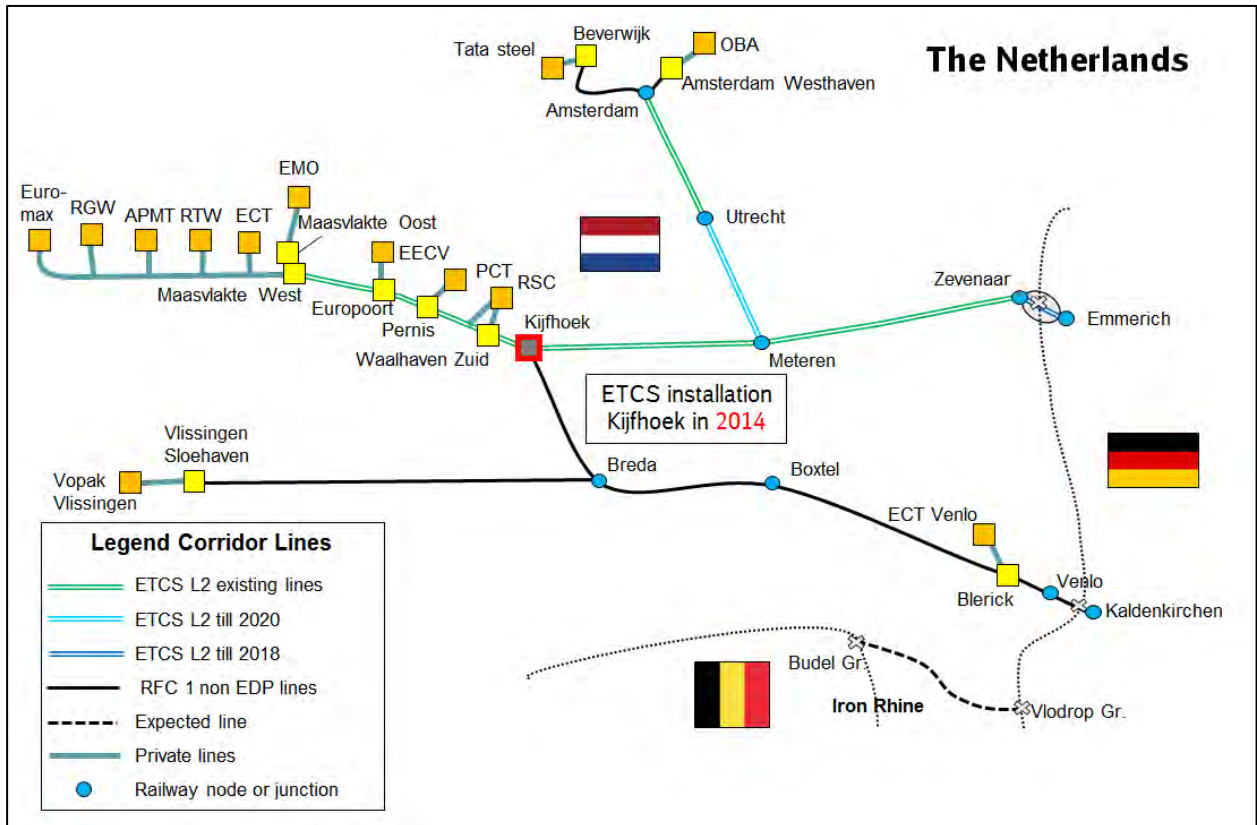
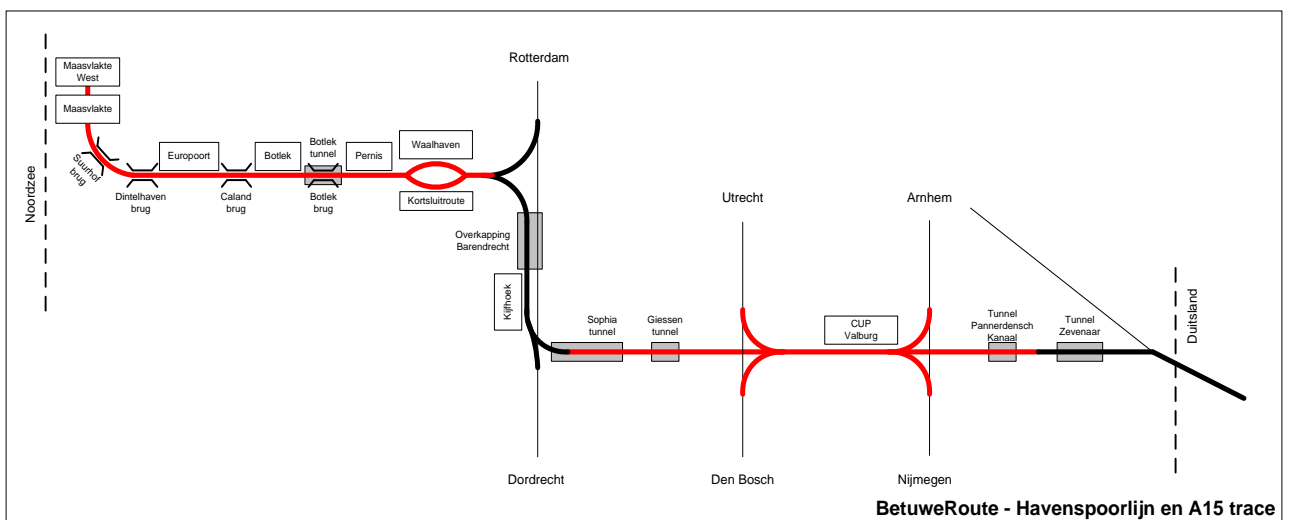

Figure 33: Map of ETCS deployment in The Netherlands

The Betuweline links the harbours of Rotterdam with the German border and consists of four sections. On the red sections (1, 3) in the figure below ERTMS is in operation since 2007/2009 and at the black ones (2, 4) the installation of ERTMS is being planned before 2015.



1

2

3

4

Figure 34: Betuweroute - Havenspoorlijn

| | section | km | connection | ERTMS |
|---|-------------|-----|---------------------------------|-----------|
| 1 | Harbourline | 40 | Seaports and Kijfhoek. | Dec 2009 |
| 2 | Kijfhoek | 8 | along marshalling yard Kijfhoek | June 2014 |
| 3 | A-15 | 100 | Kijfhoek and Zevenaar | June 2007 |
| 4 | Zevenaar | 3 | Zevenaar-border | Dec 2014 |

Table 6: Details Betuweroute - Havenspoorlijn**A-15**

This part is the newly build, dedicated freight line between the marshalling yard of Kijfhoek and the existing rail infrastructure at Zevenaar. Since the line is running along the highway A-15 this section is called the A-15 part of the Betuweline. The track has been opened on the 7th June 2009 with ERTMS Level 2. At that time software had been installed of version 2.2.2. Recently (30th June 2012), the software has been upgraded to the actual specifications of 2.3.0d.

Harbourline

The railway tracks in the harbour have been largely renewed and installed with ERTMS and 25 kV. The initial plan for Level 2 had been changed in 2008 into Level 1 for reasons of risk reduction. The possible impact on the traffic of implementing 6 new radio block centres had been estimated as too risky. Therefore Level 1 was installed and connected with the existing interlocking's.

On the 13th December 2009 ERTMS Level 1 came in operation. Since the specifications of ERTMS had become firm in 2009 the version of 2.3.0d could be applied.

Kijfhoek

The marshalling yard of Kijfhoek is the central connecting point between the parts of the Betuweline (Harbourline, A-15) and the existing lines running North (Rotterdam) – South (Antwerp). These existing lines still have the national legacy class B system. In order to facilitate the interoperability for ERTMS freight locomotives the two tracks around the marshalling yard of Kijfhoek are being equipped with ERTMS Level 1 (see appendix 1). The ERTMS will be installed and operated as a dual system in addition to the class B of The Netherlands ATBEG. This enables conventional locomotives without ERTMS on board to run the main North - South axle in The Netherlands still under the class B. The infrastructure of the marshalling yard itself is not equipped with ERTMS. The traffic at the yard is being controlled by means of the shunting mode of ERTMS in the locomotives.

Timing

| | |
|---------------------------------|---------------|
| Financial agreement by Ministry | February 2012 |
| Tender | August 2012 |
| Commissioning by ProRail | December 2012 |
| Delivery of the ERTMS | December 2013 |

Zevenaar

The most eastern part of the Dutch section of Corridor A/1 consists of existing infrastructure and is being used by freight traffic as well as by passenger traffic (ICE). The national systems for power (1.500 V) and the class B legacy are still being used between Zevenaar and Emmerich. The project at Zevenaar involves the change of the systems into 25 kV and ERTMS as well as the construction of a third track (see appendix 2). ERTMS Level 2 version 2.3.0d will be installed.

Timing

| | |
|---------------------------------|----------------|
| Financial agreement by Ministry | September 2012 |
| Tender by ProRail | October 2012 |
| Commissioning by ProRail | February 2013 |
| Testing of ERTMS | 2, 3 Q 2014 |
| Delivery of project | December 2014 |

The testing procedures to put the ERTMS in place are agreed with the project organisation at the German side are as follows:

- Install ERTMS Level 2 and combine it with the Dutch class B system (ATBEG)
- Connect ERTMS Level 2 with the German class B system PZB
- Removal of ATBEG

The planning of ProRail's project with the deadline of December 2014 includes these steps. The milestones are independent of the project of DB Netz at the German side of the border. As soon as the planning of DB Netz has become firm the connection of ERTMS 2.3.0d at Dutch side with the baseline 3 version at the German side can be scheduled. This future border connection may not happen within the deadline of 2015 and is therefore outside the scope of project Zevenaar. Firstly ERTMS at the Dutch side will operate in combination with PZB.

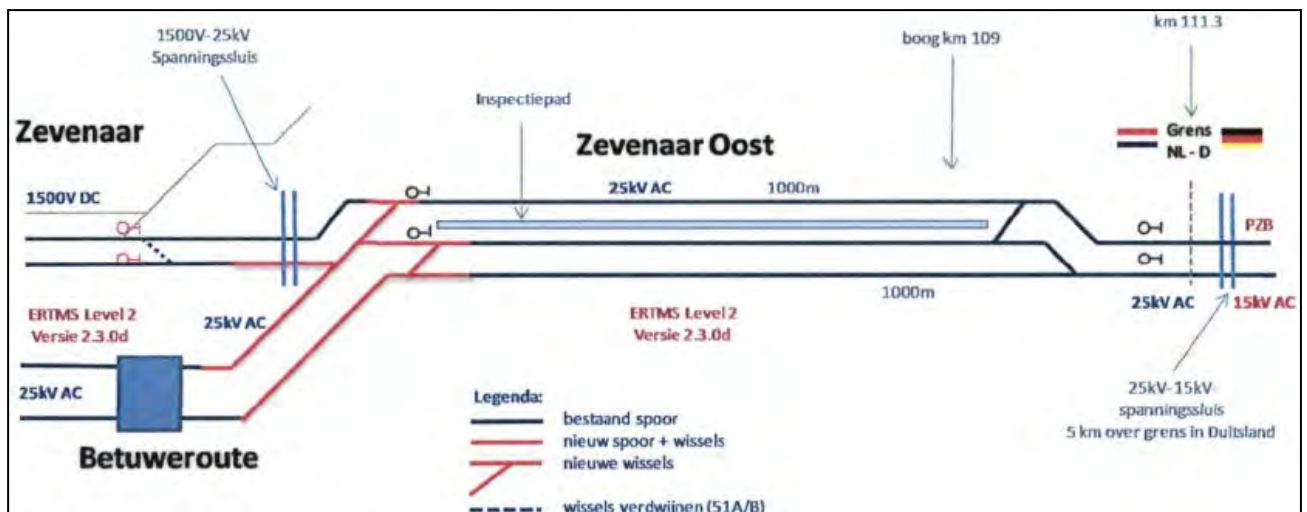

Figure 35: Detail view of Zevenaar

7.1.5.1.2 ETCS Deployment

7.1.5.1.2.1 Technical Standards, Baseline, Levels

A-15

On 30th June 2012 the ERTMS Level 2 software has been upgraded to the actual specifications of 2.3.0d.

Harbourline

On 13th December 2009 ERTMS Level 1 came in operation with version 2.3.0d.

Kijfhoek

The ERTMS will be installed and operated as a dual system in addition to the class B of The Netherlands ATBEG. This enables conventional locomotives without ERTMS on board to run the main North-South axle in The Netherlands still under the class B. The infrastructure of the marshalling yard itself is not

equipped with ERTMS. The traffic at the yard is being controlled by means of the shunting mode of ERTMS in the locomotives.

Timing

| | |
|---------------------------------|---------------|
| Financial agreement by Ministry | February 2012 |
| Tender | August 2012 |
| Commissioning by ProRail | December 2012 |
| Delivery of the ERTMS | December 2013 |

Zevenaar

The project at Zevenaar involves the change of the systems into 25 kV and ERTMS as well as the construction of a third track (see appendix 2). ERTMS Level 2 version 2.3.0d will be installed.

Timing

| | |
|---------------------------------|----------------|
| Financial agreement by Ministry | September 2012 |
| Tender by ProRail | October 2012 |
| Commissioning by ProRail | February 2013 |
| Testing of ERTMS | 2, 3 Q 2014 |
| Delivery of project | December 2014 |

The testing procedures to put the ERTMS in place are agreed with the project organisation at the German side are as follows:

- Install ERTMS Level 2 and combine it with the Dutch class B system (ATBEG)
- Connect ERTMS Level 2 with the German class B system PZB
- Removal of ATBEG

The planning of ProRail's project with the deadline of December 2014 includes these steps. The milestones are independent of the project of DB Netz at the German side of the border. As soon as the planning of DB Netz has become firm the connection of RTMS 2.3.0d at Dutch side with the baseline 3 version at the German side can be scheduled. This future border connection may not happen within the deadline of 2015 and is therefore outside the scope of project Zevenaar. Firstly ERTMS at the Dutch side will operate in combination with PZB.

7.1.5.1.2.2 Class B Systems in Use

The complete Dutch part of the Corridor will be equipped with ERTMS. In order to facilitate the interoperability for ERTMS freight locomotives the two tracks around the marshalling yard of Kijfhoek are being equipped with ERTMS Level 1. In Kijfhoek ERTMS will be installed and operated as a dual system in addition to the class B of The Netherlands ATBEG. This enables conventional locomotives without ERTMS on board to run the main North-South axle in The Netherlands still under the class B. The infrastructure of the marshalling yard itself is not equipped with ERTMS. The traffic at the yard is being controlled by means of the shunting mode of ERTMS in the locomotives.

ATB

ATB exists in two basic versions: ATB First Generation and ATB New Generation.

Description of ATB First Generation:

ATB First Generation is installed on the vast majority of lines of the Netherlands.

The system consists of coded track circuits of rather conventional design and a computerized (ACEC) or conventional electronic (GRS) on-board equipment.

The data transmission between coded track circuits and on-board equipment is via inductively coupled air coil pickup antennae above the rails.

Main Characteristics:

- Data transmission to trains:
 - 75 Hz Carrier frequency
 - AM modulated speed codes
 - 6 speed codes (40, 60, 80, 130, 140) km/h
 - 1 exit code
 - No train characteristics on board (Speed code from wayside)
- Display to driver:
 - Speed corresponding to speed code
 - Gong in case of code change
 - Bell in case the system requests brake application
- Supervision:
 - Speed (continuous)
- Reaction:
 - The emergency brake is called in the case of overspeed and the driver does not react to an acoustic warning.

Description of ATB New Generation:

ATC System partially installed on lines of the Netherlands.

The system consists of track-side balises and on-board equipment. An infill function based on a cable loop is also available.

The data transmission is between the active balise and an antenna on-board. The system is direction sensitive; the balises are mounted between the rails with a small offset from the centre.

ATBNG on-board equipment is fully interoperable with ATB first generation track-side equipment.

Main Characteristics:

- Data transmission to trains:
 - 100 kHz +/- 10 kHz (FSK)
 - 25 Kbit/sec
 - 119 useful bits per Telegram
 - Train characteristics as input by the driver
 - Train length
 - Maximum train speed
 - Train braking characteristics
- Displays to the driver:
 - Maximum line speed
 - Target speed
 - Target distance
 - Braking curve
- Supervision:
 - Line speed
 - Speed restrictions

- Stopping point
- Dynamic brake profile
- Reaction:
 - Optical pre warning
 - Acoustic warning

The emergency brake is called in the case of movement supervision is violated or the driver does not react to an acoustic warning.

7.1.5.1.2.3 National Technical Requirements for Vehicles

All requirements for Vehicles are stated in “Regeling Indienststelling Spoorvoertuigen” and is found on the Dutch government website: <http://wetten.overheid.nl/BWBR0031350>

7.1.5.1.2.4 Network Access Conditions

Most recent English version of the network statement Betuwe Line by KeyRail:
<http://www.keyrail.nl/viewer/file.aspx?fileinfoID=881>

7.1.5.1.2.5 Testing and Authorisation

For the authorization of ERTMS trackside systems there are in addition to the TSI no additional tests required.

All requirements for Vehicles are stated in “Regeling Indienststelling Spoorvoertuigen” and is found on the Dutch government website: <http://wetten.overheid.nl/BWBR0031350>

7.1.5.1.3 ETCS Roll out plan

The following table shows the overall implementation of ETCS sections in the Netherlands which are so far planned.

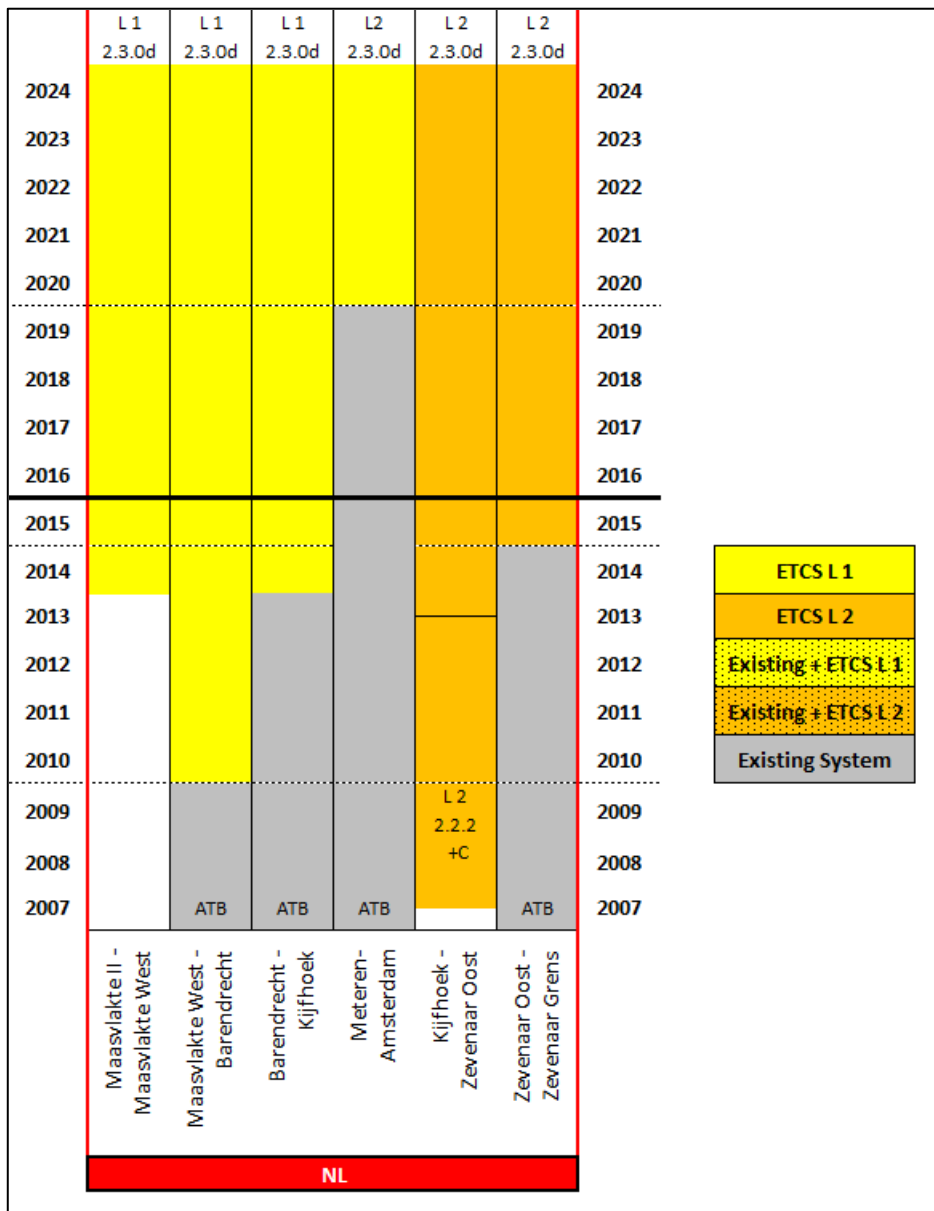

Figure 36: ETCS roll out plan in the Netherlands

7.1.5.1.3.1 Installation

This is included in 7.1.5.1.2.1 Technical Standards, Baseline, Levels and also in 7.1.5.1.1 Description of Corridor Lines.

7.1.5.1.3.2 Testing and Putting in Service

Included in 7.1.5.1.2.1 Technical Standards, Baseline, Levels

7.1.5.1.3.3 Detailed Description of ETCS Equipment on Dutch Part of Border Section Zevenaar Oost (NL) - Emmerich (DE)

Particularities

On the border sections several operational and technical changes between national infrastructures take place. Technical installations and procedures are arranged to secure the best possible migration for the railway undertakings. ETCS has to consider this as it is only one feature in this process and e. g. connected with electric power supply, communications systems or the operational language.

Dutch railway is electrified with 1500 V direct current and equipped with the ATB train supervision system. For the section Havenspoorlijn Maasvlakte – Kijfhoek (Havenspoorlijn) and the new constructed route Kijfhoek – Zevenaar Oost (Betuweroute), 25 kV alternating current and ETCS have been installed as railway supervision system. In the area of the train station Kijfhoek as well as at the border section from Zevenaar Oost to Emmerich, a switch to 1500 V direct current and the Dutch railway supervision system ATB (EG) is required (necessary) momentarily. At the train station in Emmerich, the transition to German current and train supervision system takes place with 15 kV alternating current respectively PZB 90. On the border section, specific local regulations must be observed by the RUs.

The main principle of operational change at a border train station shall be dropped in the future because the operational change will then take place on the line-track at the national border.

Currently important line properties

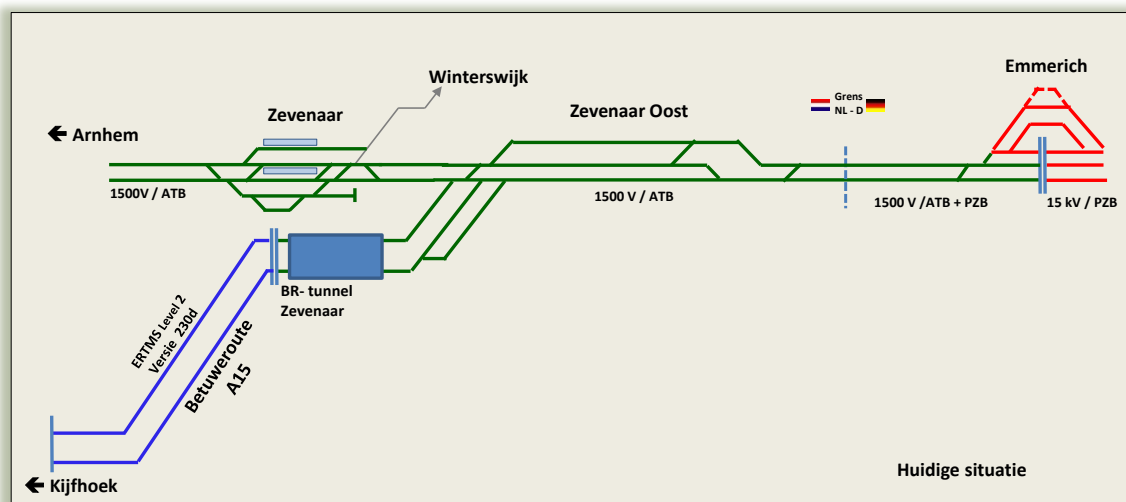

Figure 37: Power supply and signalling systems on the border section Zevenaar – Emmerich (ProRail)

- Electrification:
1.5 kV direct current
- Change of electric power supply (catenary):
Emmerich (D) station, manual switching

- Operational change:
Emmerich station
- Communication system:
Continuous GSM-R; net change between GSM-R (D) and GSM-R (NL) on outdoor sections (locally signposted)
- Control / signalling systems:
ATB (EG) on the Dutch line section until Emmerich as well as PZB 90 additionally on the German line section. In Holland up from Zevenaar Oost on the Betuweroute ETCS
- Operational language: German, Dutch (up to national border respectively)
- Operational management: ProRail, DB Netz (up to national border respectively)

Change of line properties with respect to ETCS equipment (until 2015)

The Dutch project consists of 4 stages:

1. Replacement of the ATB-EG system Zevenaar Oost by ERTMS Level 2 (planned end 2014)
2. Replacement of 25kV to 1500V at Zevenaar Oost (planned mid 2016)
3. Making the connection between the Dutch and German ERTMS system (end 2018)
4. The construction of the third track to the border (2022)

Stage 1 and 2

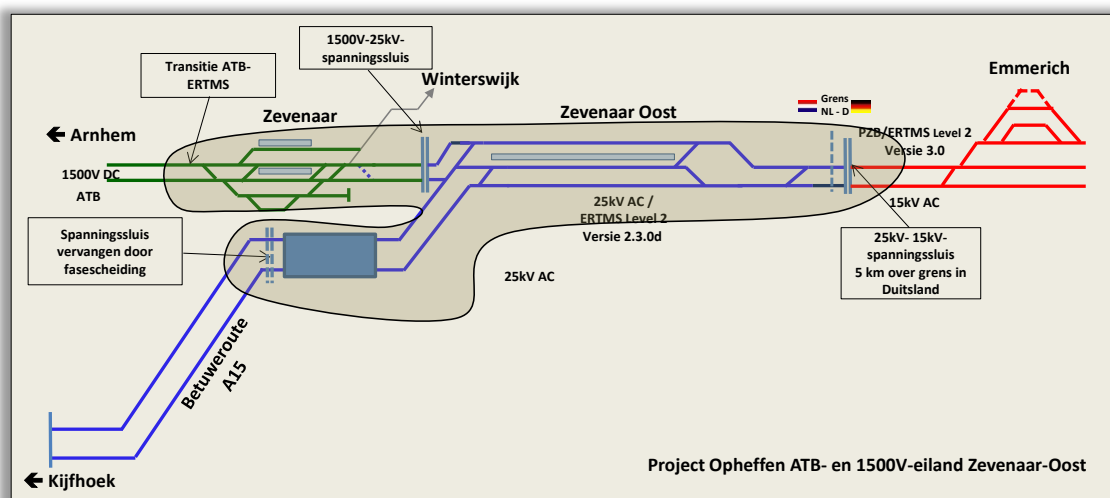

Figure 38: Phase 1 of ETCS roll out on the border section Zevenaar Oost and Emmerich (ProRail)

ERTMS

The section at Zevenaar Oost will be provided with the same ERTMS L2 system as the Betuweroute.

- Electrification:
- In the Dutch section, the continuation of the electrification is planned on the Betuweroute with the already installed 25 kV alternating current up to appr. 5 km over the national border in Germany and subsequently on the German section until Emmerich with 15kV alternating current. In the Netherlands a transition over to the conventional 1500 V direct current between Zevenaar and Zevenaar Oost is foreseen.

- Operational change:
- On the line-track at the border point The continuation of the ETCS L2 installation on the Dutch route section of the Betuweroute up to the national border as well as the German route section up to Emmerich is planned. In the German section parallel equipment with PZB 90 is foreseen.
- Responsible for the equipment: ProRail, DB Netz (up to property border respectively)
- Responsible for the approval: N.n. (NL), EBA (up to national border respectively)

Stage 3

In this stage, the Dutch ERTMS system, which at that time is still connected to the German PZB system, will also be connected to the new ERTMS Baseline 3 system in Germany. The completion of Step 3 is dependent on the time DB Netz has also carried out the roll out of ERTMS. The PZB system in Germany will remain.

Stage 4

In this stage a third track will be created between Zevenaar Oost and the border.

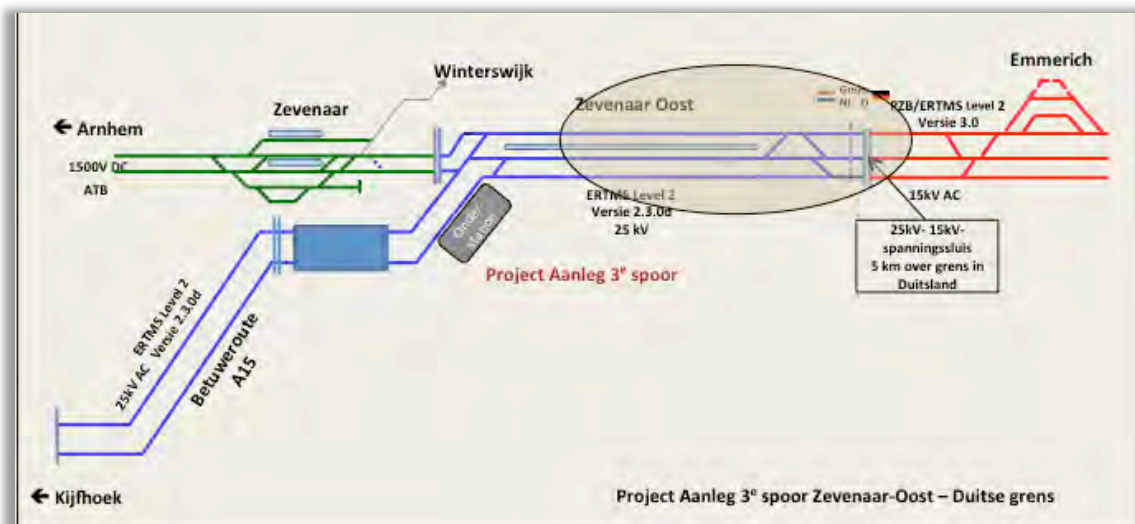

Figure 39: Phase 2 of ETCS roll out and installation of 3rd track on the border section NL/DE (ProRail)

7.1.5.1.3.4 Investments

Not specified

7.1.5.2 Belgium

The Belgian section of RFC 1 is not part of the European Deployment Plan and does not have to meet the obligatory deadline. Therefore ETCS implementation is not described here, but under 7.1.6.2 Belgium.

According to chapter 7.3.2.2 & 7.3.5 of the TSI CCS (Decision 2012/88/EU) linking Gent and Zeebrugge to at least one of the six corridors specified in chapter 7.3.4 by 2020, in casu Corridor A, is mandatory.

7.1.5.3 Germany

The present Implementation Plan ERTMS is a display of an equipping option and is subject to a planned financing agreement. Only the Corridor A projects Emmerich – Oberhausen and node Basel are secured by a financing agreement.

7.1.5.3.1 Description of Corridor Lines

See Corridor A lines Germany:

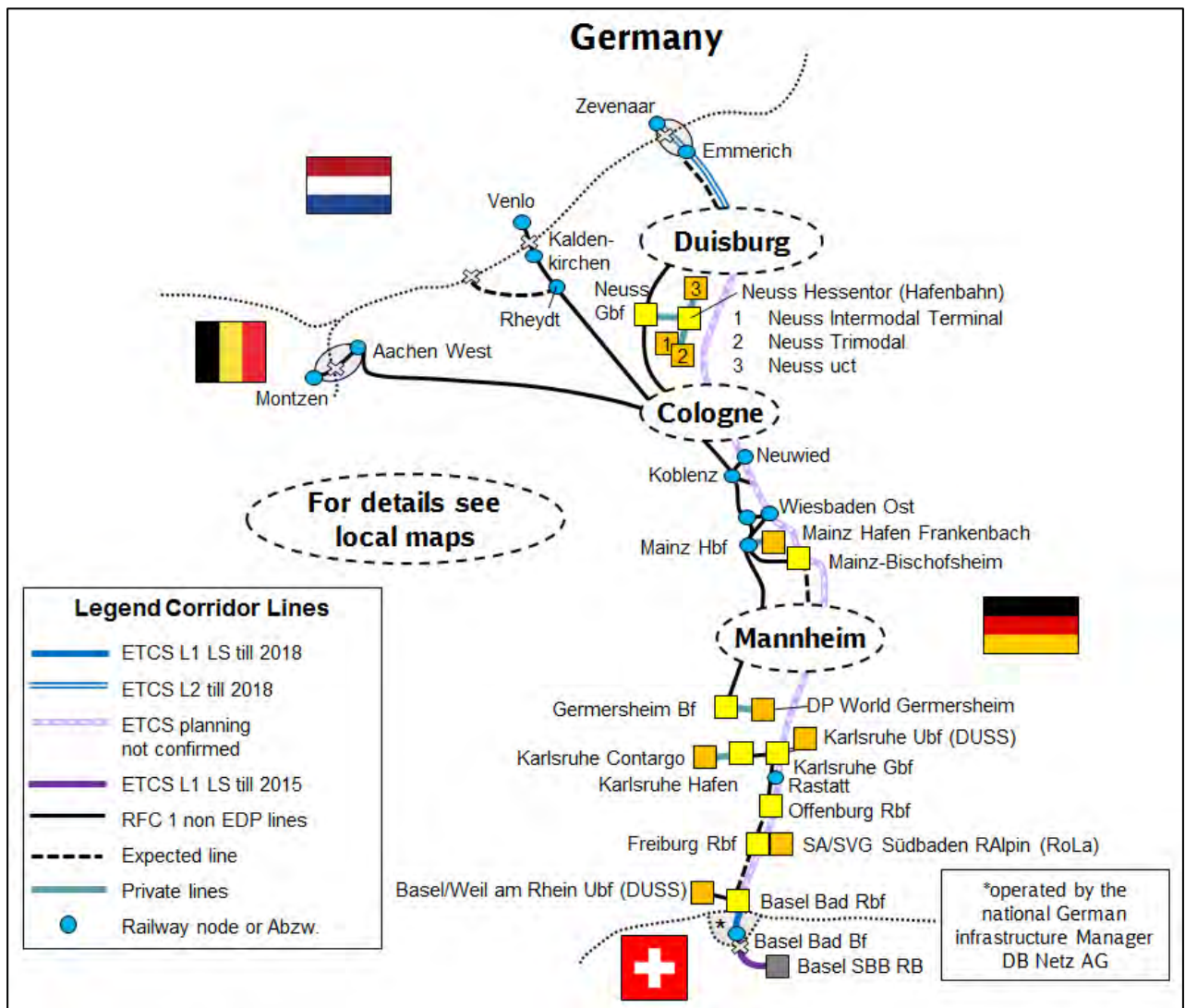

Figure 40: Map of ETCS deployment in Germany.
The map details shown do not necessarily correspond to the EDP

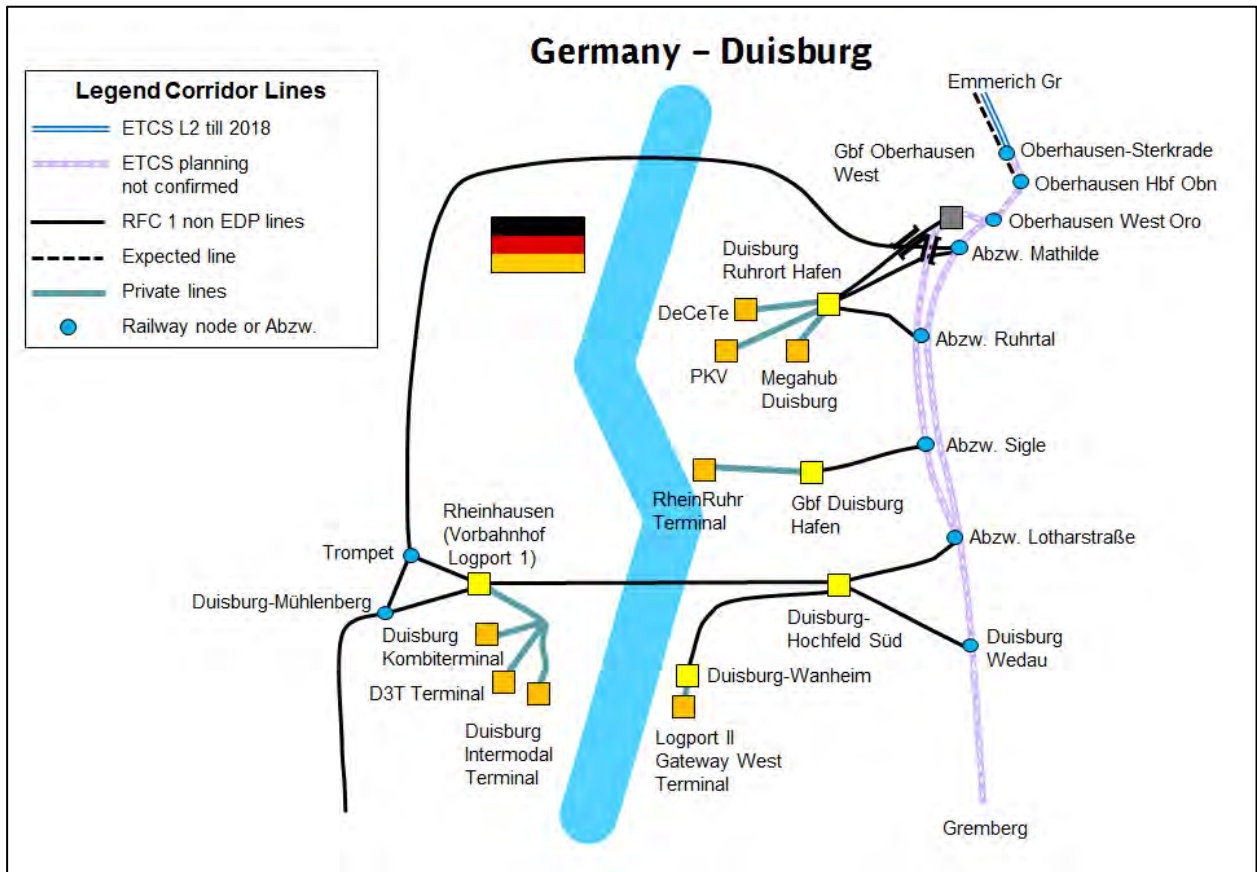

Figure 41: Map of ETCS deployment in Germany (detail Oberhausen/Duisburg).
 The map details shown do not necessarily correspond to the EDP

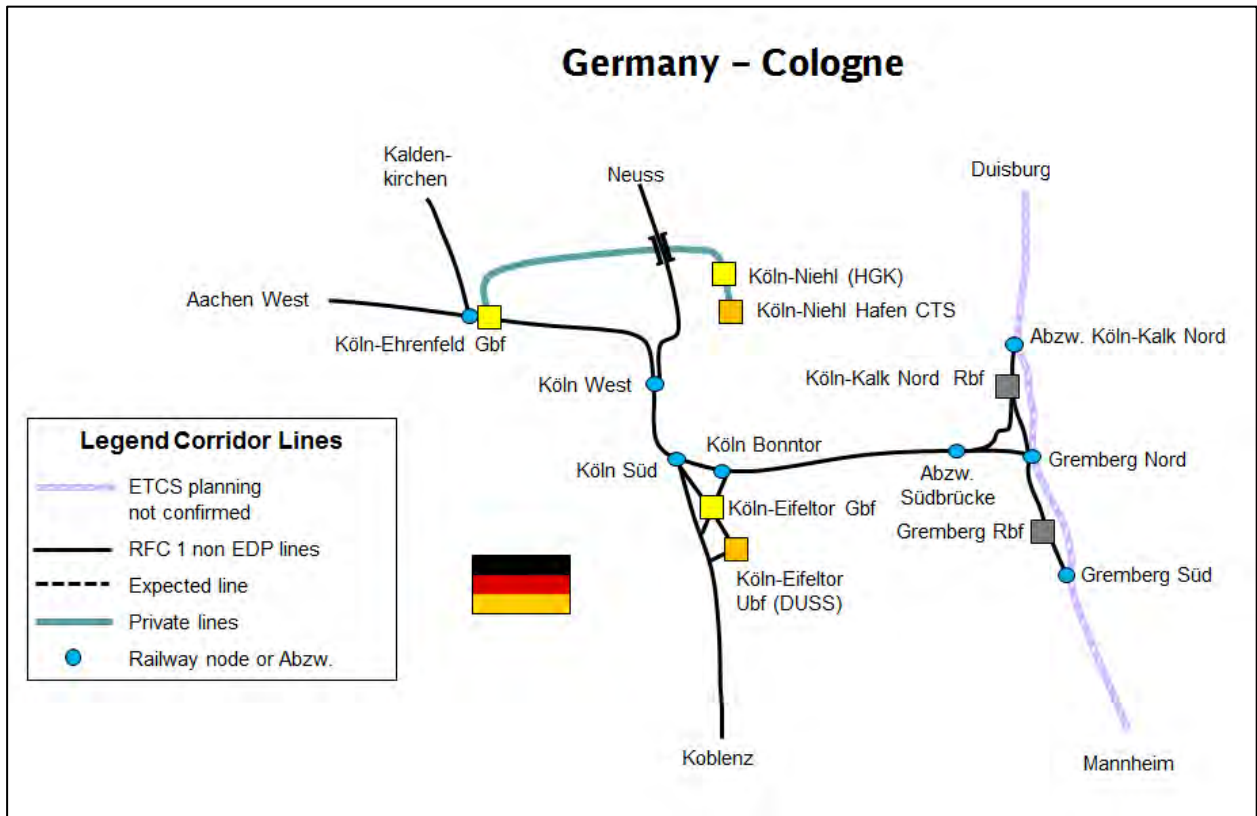

Figure 42: Map of ETCS deployment in Germany (detail Cologne).
 The map details shown do not necessarily correspond to the EDP

7.1.5.3.2.3 National Technical Requirements for Vehicles

KMC: None (Key Management takes place as described in subset 38).

Vehicles intended for deployment over ETCS lines under ETCS control need a national approval for these lines, for which the requirements of national specifications must be fulfilled.

Additional requirements may arise during the course of the project as a result of the technical realisation of vehicles and/or lines. Switzerland and Germany ask for a change request related to the vehicles to guarantee a safe operation under Level 1 Limited Supervision.

DB, SBB and RFI launched another Change Request concerning the behaviour of the DMI in ETCS Level 1 LS, which in Germany will be necessary for a successful National Safety Approval of the according operational scheme. As agreed with the EU ERTMS Coordinator, the EC and ERA, this CR will be a prerequisite for the implementation of ERTMS in Germany.

Note: The list of our national technical rules is preliminary. In the framework of the assessment of our requirements specification (German: “Neue Typzulassung”) it might become necessary for us to address additional national technical rules to the train operators, or some of the national technical rules might be deleted.

National technical requirements for the SRS 3.3.0

1_BL3: If the emergency brake has been triggered in level STM, e.g. (signal on stop position), the access to the emergency brake command output is revoked by the EVC, if the train passes the border to a different level. This may lead to a safety critical situation if the conditions to command the emergency brake are still valid, but the EVC, now, e.g., in ETCS L1, has no knowledge of the history before the change of level. CR U998

2_BL3: Level selection by driver: No offering of STMs to the driver which the on-board is not equipped with, thus selection must be restricted to real on-board configuration CR U954.

3_BL3: Level transition orders have to be acknowledged by the driver according to infrastructure rules. CR U70

6_BL3: An unlinked group of balises may be placed temporarily on the trackside in order to transmit a TSR due to damages on the trackside. The confidence interval of location information given by an unlinked balise must not be reset on basis of linking information from linked groups of balises given together with an MA. CR U870

11_BL3: On lines where packet switching (e.g. GPRS) is used the train must necessarily also be able to communicate with the RBC using this radio standard. CR U741

12_BL3: An uninterrupted communication must be ensured also during a NRBC transition. Therefore the implementation of two mobiles on board is required.

14_BL3: The DMI must enable the driver to preselect a certain speed value. CR E398

15_BL3: In Germany the ETCS functionality Route Suitability must be deactivated on board. CR U823

18_BL3: The driver shall acknowledge each brake command individually, also in case of the respective function has become inactive (e.g. due to a mode transition). CR U1021

21_BL3: In ETCS Level 2 mode SR the possibility of “Start” shall be offered only in the case of an already existing communication session. CR U1033

23_BL3: In mode NL text messages shall not be displayed to the driver. CR U1089

28_BL3: In mode SR the same icon as in mode FS shall be used to display a level-crossing failure, not a text message. CR E319

30_BL3: A change of train category of tilting trains due to a failure of the tilting system must not lead to braking to standstill. As a fall-back the train shall use a lower speed profile for non-tilting trains stored on-board instead which trackside has sent together with the higher speed profile for tilting trains. CR U743

35_BL3: The ERTMS/ETCS on-board equipment shall be robust against interferences between BTM and trackside big metal masses. CR U988

38_BL3: DB Netz uses only packet 40 to send information regarding the actual limitation of the current consumption and not via variable NID_CTRACTION. Therefore, the on-board shall control the current consumption only according to packet 40 information, not according to NID_CTRACTION.

40_BL3: The ERTMS/ETCS on-board equipment shall provide the necessary information to the rolling stock equipment for automatic driving and braking. CR E399

41_BL3: To ensure at least the same level of safety and performance like PZB/LZB all the required functionalities described in the requirement specification STM of DB Netz must be implemented.

7.1.5.3.2.4 Network Access Conditions

Network statement DB Netz AG ETCS (in English, German also available):

http://fahrweg.dbnetze.com/file/2361694/data/snb_2013.pdf

http://fahrweg.dbnetze.com/file/3216544/data/snb_2014.pdf

Link to the appendices (i.e. the so-called “810 guideline”):

http://fahrweg.dbnetze.com/file/2950454/data/snb_2014_anlage_2.4.pdf

The owner of these documents is DB Netz AG

Publisher: Market planning and sales

For questions, please contact: dbnetz@deutschebahn.com

The safe integration within the framework of the existing railway system of Germany has to be demonstrated. This is required for every new system which has influence on the existing level of safety. It must be demonstrated that the new system complies with or even improves the existing level of safety. In order to get the authorization for Placing in Service by EBA, the network access tests have to be successfully completed.

7.1.5.3.2.5 Testing and Authorisation

The test and authorisation process will be organised in a way that the authorisation of vehicles will be facilitated. This includes the following provisions to be fulfilled by the manufacturer of the trackside ETCS equipment:

- 1) The manufacturer has to provide the track description, engineering data and track-train system validation test cases for the implementation of the contracted trackside ETCS equipment in accordance to a common standard, based on subset-110,111,112.

- 2) The manufacturer has to provide all test cases that are required to prove safe and interoperable operation under the specific conditions of this ETCS infrastructure system. The test cases shall meet the specified operational conditions in combination with on-board CCS subsystems certified to comply with the European standard.
- 3) For this purpose, the infrastructure manager will provide a set of operational test scenarios in European standardised format, that cover the operation of ETCS on the specific line. The manufacturer has to demonstrate that these operational test scenarios are fully covered by his tests. Any deviation has to be agreed with the infrastructure manager.
- 4) The manufacturer has to use a laboratory test environment according to the principles of UNISIG subset 110, 111, 112.
- 5) On request of the infrastructure manager, the manufacturer has to perform track-train system validation tests with on-board units of at least 1 different supplier.
- 6) The laboratory tests shall be performed using the above mentioned track description and engineering data together with, for Level 2 sections, the real RBC hardware and software version.
- 7) For the purpose of authorisation of rolling stock, the trackside manufacturer has to provide the laboratory test environment including technical support for tests with on-board units of railway undertakings that apply for authorisation on a specific line.
- 8) If necessary, the manufacturer has to cooperate in field tests and test result analysis that have to be performed with ETCS vehicles of railway undertakings for their authorisation on the specific line.
- 9) Before placing in operation the trackside equipment, on request of the infrastructure manager, the manufacturer has to support cross field tests with vehicles of different suppliers.

Definitions, requirements and procedures are laid down and agreed on in the modular contract ETCS of the DB Netz AG.

7.1.5.3.3 ETCS Roll Out Plan

The following table shows the overall implementation of ETCS sections in Germany which are so far planned.

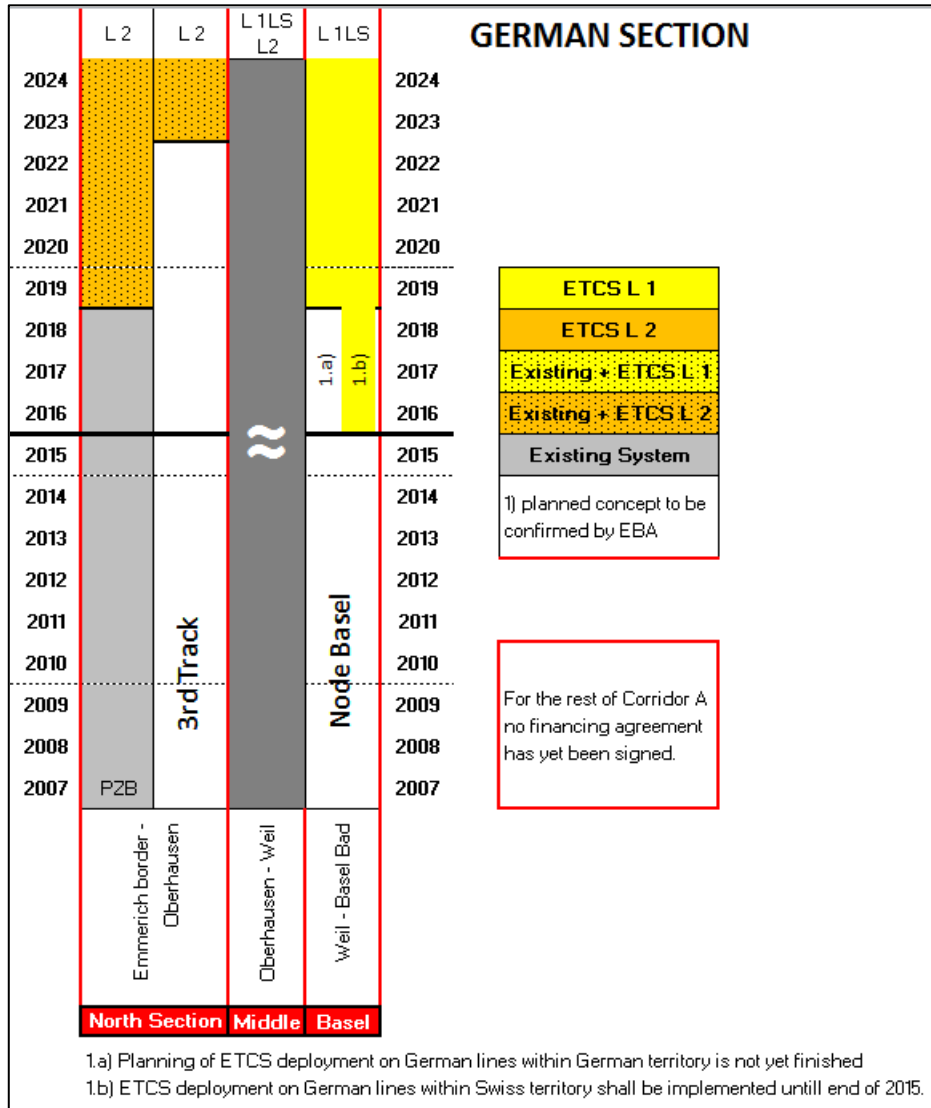

Figure 44: ETCS roll out plan in Germany

7.1.5.3.3.1 Installation

ERTMS implementation in the section Oberhausen – Emmerich

Interface outline Step 1

Border crossing Emmerich – Zevenaar-Oost

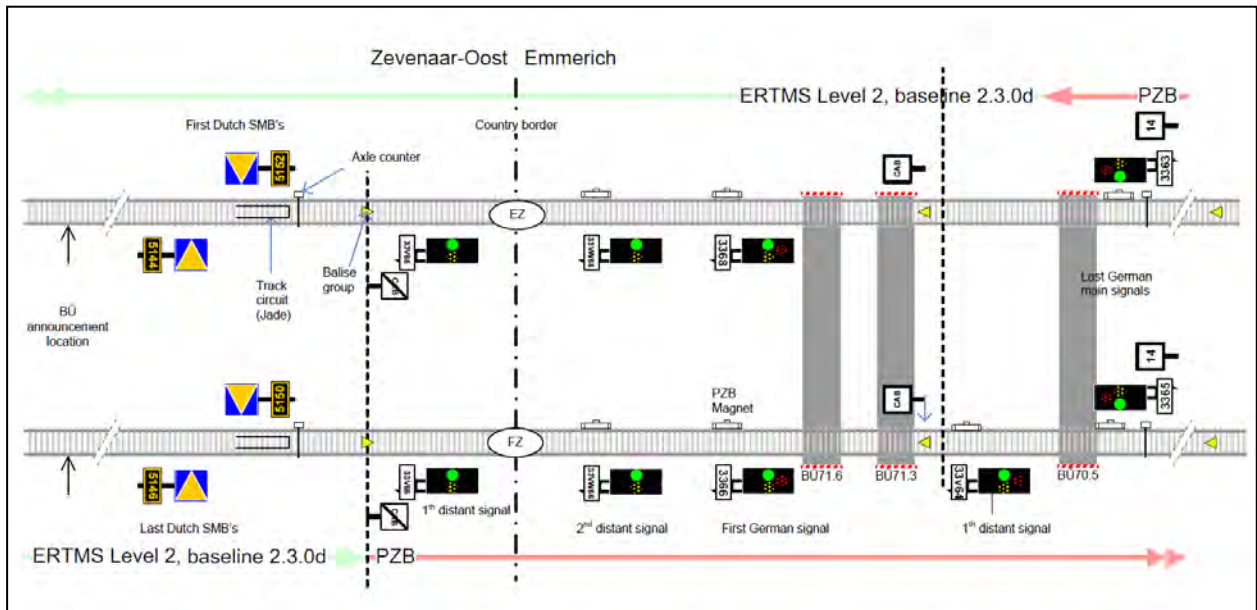

Figure 45: ERTMS border crossing NL/D

The preplanning for ETCS including the planning for GSM-R improvement was finalised in 2012. The commissioning of ETCS on the existing tracks is currently planned for the end of 2018.

ERTMS implementation in the border section Emmerich - Zevenaar-Oost

The Netherlands decided in March 2012 to implement ETCS Level 2 SRS 2.3.0d in the section between Zevenaar-Oost and the border. In a first project step (step 1) the transition will be made from ETCS L2 2.3.0d in the Netherlands to PZB in Germany. For this purpose a specific interface requirement specification (IRS) for Step 1 has been defined in 2012/2013.

Furthermore, the existing GSM-R networks in the border area were measured in 2012. Necessary changes for the ETCS implementation were planned and a new bilateral cross-border frequency plan was developed.

The commissioning of the ETCS L2/PZB transition (Step 1) is planned for end of 2014. At the same time, ATB will be taken out of operation in the border section.

The coordination dialogue between ILT, EBA, ProRail and DB Netz as regards test, compliance test and commissioning processes in the border section between Zevenaar and Emmerich started in 2012. The aim is to arrange for a mutually agreed process description of how testing and commissioning shall be done in the border section, taking into account the common safety methods (CSM).

Further steps will be the implementation of the catenary system change including the voltage change overs (VCO) in the border section, and the implementation of ETCS L2 (Baseline 3) in the section Emmerich border - Oberhausen-Sterkrade.

Operational scenarios

In 2012, all expected operational scenarios were discussed in the common operational subgroup. As a result, a draft document was issued for all scenarios.

ERTMS implementation in the border section Basel in the target situation (permit procedure sections 9.2 and PfA 9.3 of the new line KaBa)

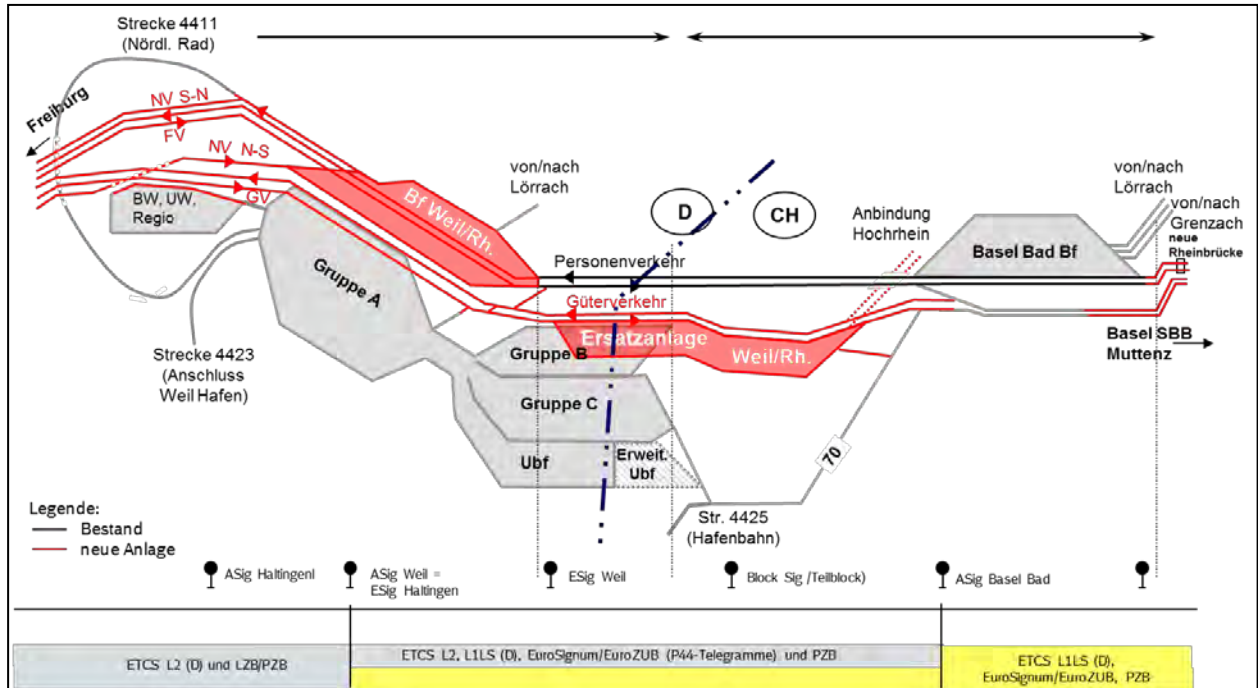

Figure 46: ERTMS target situation border D/CH

Since 2010, a joint working group DB Netz/SBB Infra and a Steering Committee with representatives of DB Netz, SBB Infra, EBA, BAV have been working on technical train control concepts.

On 18.01.2011, an overall concept for the equipment of the infrastructural region around Basel has been submitted to the EBA, taking account of following needs:

- Swiss need of equipment with EuroSIGNAL/EuroZUB
- Swiss need of equipment with ETCS Level 1 LS
- Existing PZB/LZB including PZB retrofitting according to INA calculations
- TSI CCS obligation to equip Corridor A with ETCS
- Obligation for ETCS equipment for the major project Karlsruhe – Basel according to TSI CCS
- HS requirements on the branch towards the Katzenberg tunnel + Katzenberg tunnel ETCS Level 2 high capacity block

This concept shows clearly the feasibility of EuroZUB/EuroSIGNAL and ETCS Level 1 LS in the permit procedure section 9.3.

EBA and BAV have set up an agreement on how to deal with the authorisation of technical components in border-crossing areas for ETCS implementation.

7.1.5.3.3.2 Testing and Putting in Service

See 7.1.5.3.2.5 Testing and Authorisation

7.1.5.3.3.3 Detailed Description of ETCS Equipment on German Part of Border Section Zevenaar–Oost (NL) – Emmerich (DE)

At the border section several operational and technical changes between national infrastructures take place. Technical installations and procedures are arranged to secure the best possible migration for the railway undertakings. ETCS has to consider this as it is only one feature in this process and e.g. connected with electric power supply, communication systems or the planning of the third track.

Dutch railway is electrified with 1500 V (DC) and equipped with ATB (EG) as class B CCS system. The new line Kijfhoek – Zevenaar Oost (Betuweroute) is electrified with 25 kV (50Hz) and ETCS Level 2 as CCS system. In the area of Kijfhoek as well as at the border section from Zevenaar Oost to Emmerich, a voltage change over (VCO) to 1500 V (DC) and ATB (EG) is required momentarily. The transition VCO to 15 kV (16.7 Hz) takes place at Emmerich station. The transition from ATB to PZB takes place at the border or at Emmerich station, depending on train equipment. At the border section, specific local regulations must be observed by the RUs.

The main principle of operational change at a border stations shall be dropped in the future because the VCOs and transitions will then take place at the line-track near the border.

Cross border line sections:

| Line name/ -number | station / station part / border point | | km | |
|-----------------------|---------------------------------------|-----------------|-------|-------|
| | from | to | from | to |
| 2270 | Emmerich | Emmerich-Grenze | 60.4 | 72.6 |
| Arnhem - Zevenaar | Zevenaar - | Border NL-D | 108.4 | 111.0 |

Currently important line properties

- Electrification: 1.5 kV direct current
- Change of electric power supply (catenary):
Emmerich (D) station, manual switching
- Operational change:
Manually at Emmerich station or automatically with Class B / class B Transition at the border
- Communication system:
Continuous GSM-R; net change between GSM-R (D) and GSM-R (NL) on outdoor sections (locally signposted)
- Control/command and signalling systems:
ATB (EG) on the Dutch line section from Arnhem via Zevenaar up to Emmerich station ETCS Level 2 from Kijfhoek to Zevenaar-Oost (Betuwe Route) PZB 90 additionally on the German line section from Emmerich station to the border.
- Operational language: German, Dutch (up to national border respectively)
- Operational management: ProRail, DB Netz (up to national border respectively)

1 Current status

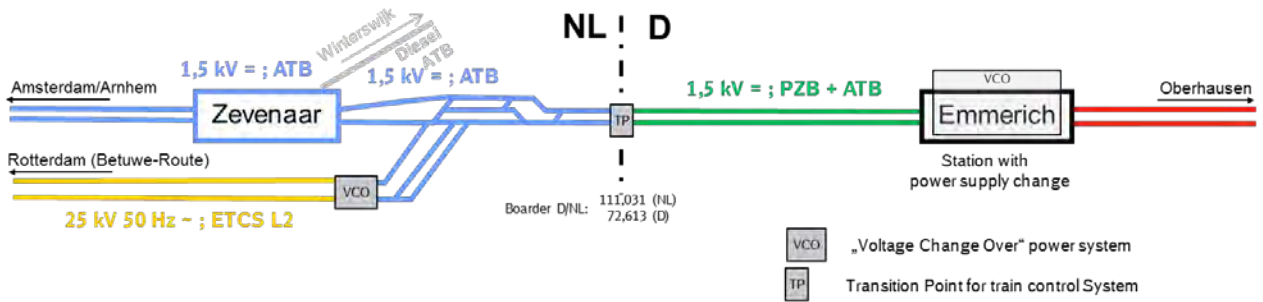

Figure 47: Power supply and signalling systems on the border section Zevenaar – Emmerich (DB Netz)

Change of line properties with respect to ETCS equipment (until 2015)

- Electrification:
In Dutch territory, the extension of 25 kV (50Hz) from the Betuwe Route up to the new VCO to 15 kV (16.7 Hz), 5 km inside the German territory, is planned. In the Netherlands, the VCO to 1500 V (DC) is foreseen between Zevenaar-Oost and Zevenaar.
- Change of electric power supply (catenary):
On the line-track close to the border (km 67.2 – 67.7)
- Operational change:
On the line-track at the border point
- Control / signalling systems:
The following equipment will be implemented

Step 1: ETCS L2 SRS 2.3.0d on Dutch territory, PZB on German territory

2 Step 1: End 2014; Change of CCS

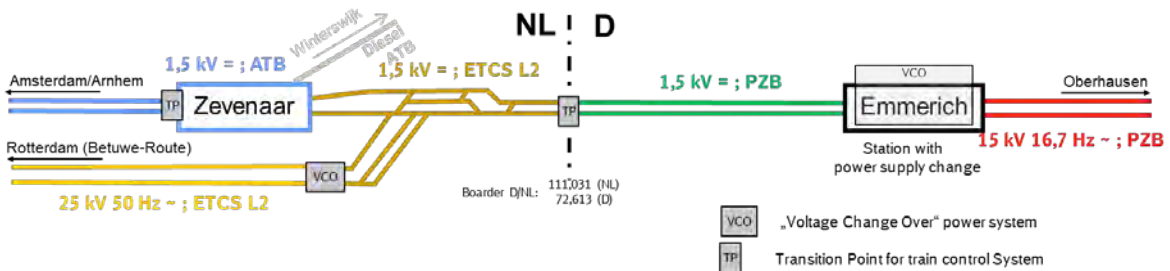

Figure 48: Step one of ETCS roll out on the border section Zevenaar Oost and Emmerich (DB Netz)

Step 2: Change of catenary system. (VCO)

3 Step 2: Change of power supply and first changes of tracks in Zevenaar-Oost

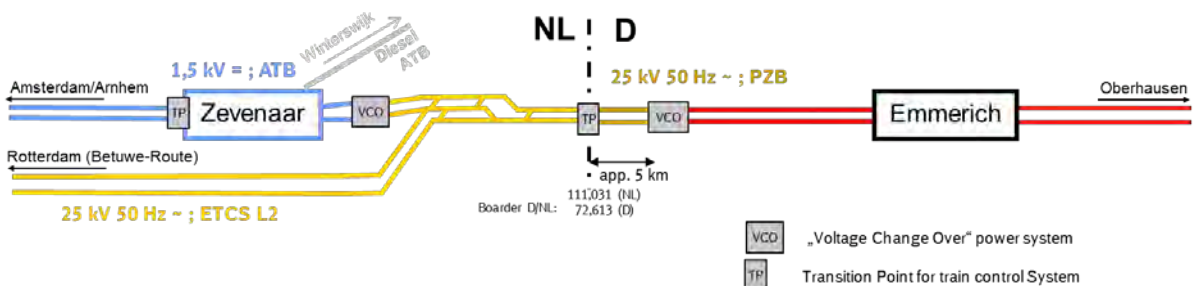

Figure 49: Step two of ETCS roll out on the border section Zevenaar Oost and Emmerich (DB Netz)

Step 3: ETCS L2 Baseline 3 on German territory

The equipment of the line 2270, Oberhausen – Emmerich-Grenze (border), with ETCS L2 (B3) is currently foreseen from Oberhausen-Sterkrade (km 0.6) to Emmerich-Grenze (km 72.6).

4 Step 3: ETCS Level 2 Baseline 3 in Germany and third track in the Netherlands

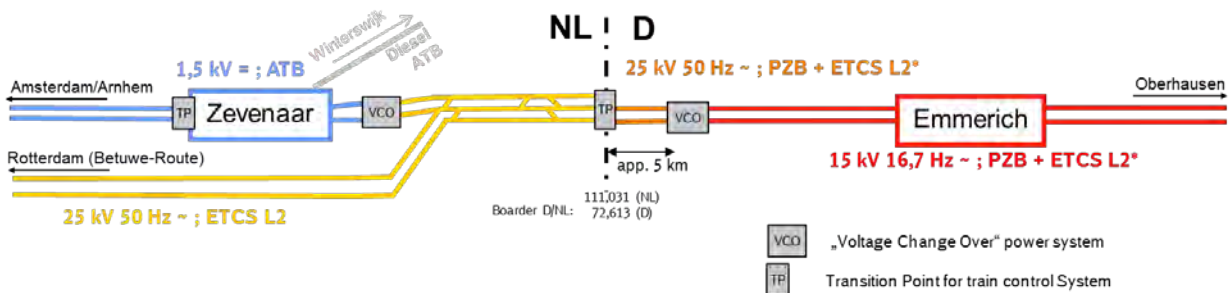

Figure 50: Step three of ETCS roll out on the border section Zevenaar Oost and Emmerich (DB Netz)

Step 4: Third track

5 Step 4: Third track in Germany

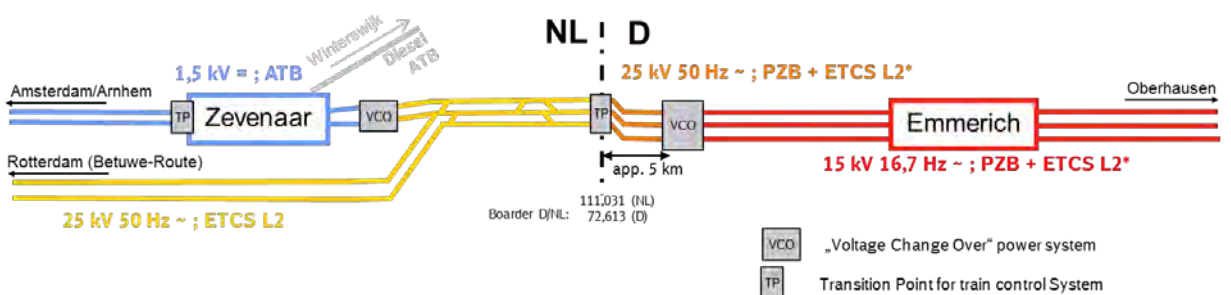

Figure 51: Step four of ETCS roll out and installation of 3rd track on the border section Zevenaar Oost and Emmerich

- The extension From ETCS L2 (SRS 2.3.0d) on the Betuweroute up to the national border as well as the ETCS L2 (Baseline 3) implementation on the German section up to Emmerich is planned in different steps. In the German section ETCS L2 and PZB 90 is foreseen.
- Responsible for the equipment: ProRail, DB Netz (up to property border respectively)
- Responsible for the approval: ILT (NL), EBA (up to national border respectively)
- Project status: in planning (Separate ETCS-Project, Part of the National Equipment Plan?)
- Tentative date of implementation:
 - Step 1: End 2014
 - Step 2: End 2016
 - Step 3: End 2018
 - Step 4: not specified

7.1.5.3.3.4 Detailed Description of ETCS Equipment on the Border Section Weil am Rhein (DE) – Basel SBB (CH), Including German Lines Within Swiss Territory

Particularities

On the border sections, several operational and technical changes between national infrastructures take place. Technical installations and procedures are arranged to secure the best possible migration for the railway undertakings. ETCS has to consider this as it is only one feature in this process and e. g. connected with electric power supply, communications systems or the operational language.

a) Network access “German railway sections on Swiss Territory“

In the Basel area, the business unit Infrastructure Switzerland of the DB Netz AG operates on behalf of the Federal Railway Funds of the Federal Republic of Germany under the protection of interests of the Swiss railway lines on Swiss territory. The DB Netz AG is represented through the appointee that has been nominated by the German infrastructure on the railway lines on Swiss territory.

For the utilisation of these routes, the “Swiss Railway Network Access Ordinance” (NAO) as well as the “general terms & conditions of business” for the use of railway infrastructure of the DB Netz AG, GE Infrastructure Switzerland” are binding. The spatial situation of these routes and the applicable legal bases that apply can be seen at:

DB Netz AG – Informations about lines in Switzerland

A railway undertaking that is registered in the Federal Republic of Germany needs an operating permit in order to use the railway lines on Swiss territory. Such an operating permit is granted by [Schweizerische Bundesamt für Verkehr \(BAV\)](#) in Bern and can be used for the wagons rolling on the routes. A safety certification and a signed network access agreement with the DB Netz AG Infrastructure Switzerland have to be negotiated according to the NAO.

b) Network access to Swiss standard gauge

Every railway undertaking that has been certified in the Federal Republic of Germany has to have an additional operation certification issued by the BAV for the use of the Swiss standard gauge network in order to run their wagons on the related lines. It also needs a safety certificate and a network access agreement according to the Swiss Railway Network Access Ordinance (NAO). The following link will lead you to the relevant guide of the BAV for the network access in Switzerland: [BAV Leitfaden Netzzugang](#).

c) Catenary System

The electrified German railway lines on Swiss territory and the Swiss railway network are operated with the same current system utilised in Germany. Due to a different construction of the catenary system in the Swiss Railway Network, some particular requirements related to the equipment of the engines have to be taken into consideration. The method of construction of the catenary demands capable pantographs for each national system. Cross-border operation of engines requires the allowance of the BAV.

Cross border line sections (in respect of ETCS installation):

| Line name/ -number | station / part of station / border point | | km | |
|-----------------------|--|--------------|-------|-------|
| | from | to | from | to |
| 4000 | Haltingen Bst | Basel Bad Bf | 264.3 | 272.2 |
| 4404 | Basel Bad Bf | Basel Grenze | | |

Currently important line properties

- Electrification: 15 kV alternating current
- The lines can be run with German and Swiss pantographs
- Operational handover stations:
- Basel Bad Rbf, Basel Bad Pbf, Basel SBB RB Muttenz
- Communication system:
- continuously GSM-R; net change between GSM-R (D) and GSM-R (CH) on outdoor sections (locally signposted)
- Control / signalling systems:
- PZB 90 (DB Netz AG) up to Basel SBB PB and RB, Signum (SBB) up to Basel Bad Bf respectively Basel Bad Rbf, Weil a. R.
- Lingua franca: German
- Operational Management:
- DB Netz AG, Business Unit “Infrastructure Switzerland“

Preliminary planning for the change of line properties with respect to an ETCS-equipment until 2015

This is without prejudice to the competence of the Member State regarding infrastructure planning and financing. Also this is without prejudice to any financial commitment of a Member State.

- The following equipment will be implemented
 1. (e. g. EuroSignum/EuroZUB and ETCS L1 LS specification Germany)
 - a) Line 4000 from Basel Bad Bf to Weil a.R.
 - b) Line 4404 from Basel Rheinbrücke to Basel Bad Bf
 - c) Line 4425 Track 70 to Kleinhüninger Hafen

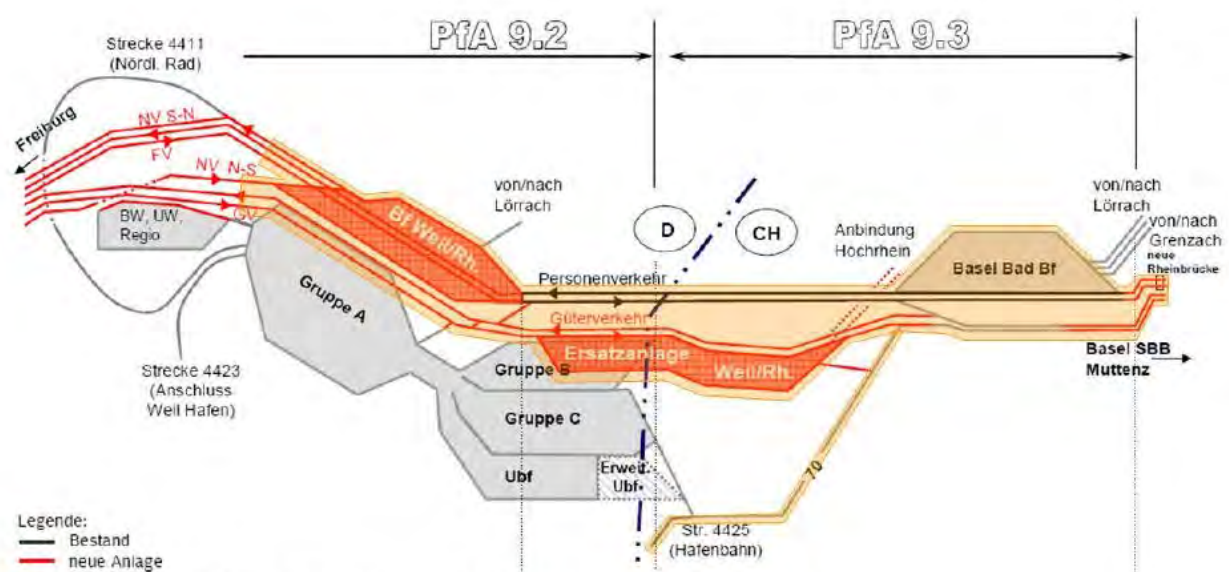

Figure 52: Node of Basel ETCS L1LS in North-South direction (highlighted in orange)

2. (e. g. EuroSignum/EuroZUB and ETCS L1 LS specification Germany)

- a) Line 4000 from Basel Bad Bf to Basel Rheinbrücke
- b) Line 4425 from Kleinhüninger Hafen to Track 70

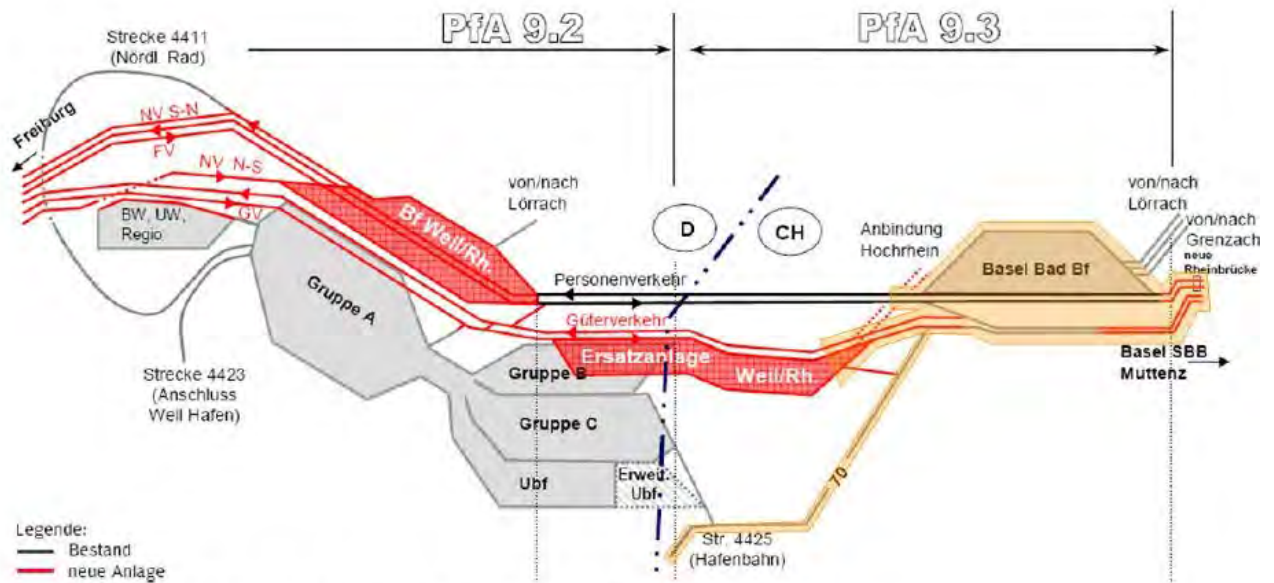

Figure 53: Node of Basel ETCS L1 LS in South–North direction (highlighted in orange)

3 (e. g. ETCS L2 in both directions)

- a) Line 4000 and 4280 from Bst Haltingen via Weil a.R.
- b) Line 4411 the so-called “wheel” (cf. picture left side) in Bst Haltingen
- c) Weil am Rhein set A of departure sidings and set F of alternate sidings

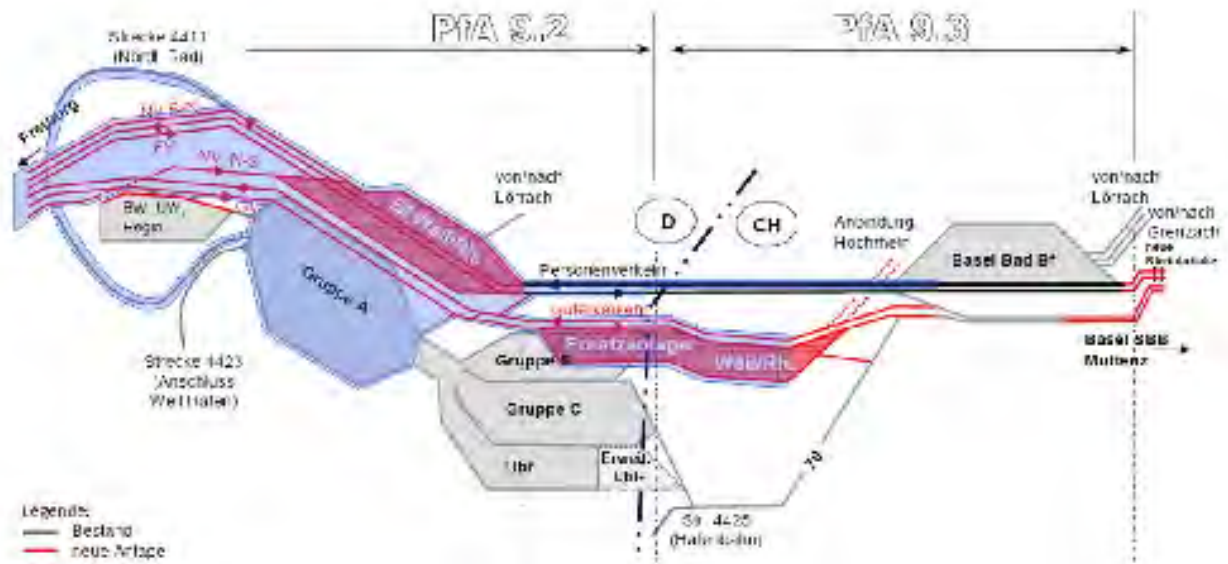

Figure 54: Node of Basel ETCS L2 direction south – north (highlighted in blue)

- Responsible for the equipment: DB Netz AG
- Responsible for the approval: (Swiss equipment in the operational management of the national German infrastructure managers DB Netz):
 - The approval process is defined between BAV and EBA according to the concept

“Zuständigkeit für die Zulassungs- und Bewilligungsaktivitäten bei der Zugbeeinflussungsausrüstung für Grenzbetriebsstrecken und Durchgangsstrecken Schweiz – Deutschland”. Paragraph 8.6.3 is valid for German signals on Swiss Territory – under responsibility of BAV - and paragraph 8.6.4 for German signals on German Territory – under responsibility of EBA -.

- Project status:
 - The node Basle (section Weil am Rhein via Basle Bad Bf to Rheinbrücke) is part of the Bedarfsplan-Project NBS/ABS Karlsruhe – Basle. The financial contract with BMVBS is signed and approval process is on-going. The installation of ETCS is integrated part of the project according to TSI. The commissioning of the continuous line is planned for 2020/2022.
- The existing line 4000 from Weil am Rhein to Karlsruhe is defined as Corridor A. According to the national equipment plan, this line will be equipped with ETCS until 2018. In detail:
 1. Installation of EuroSignum/EuroZUB in the node Basle until 12/2014 according to migration guideline BAV
 2. The Katzenberg tunnel is planned to be equipped with ETCS L2 until 2018. A technical concept for the ETCS transition to the south (PfA) sections is currently being investigated.
 3. Installation of ETCS L1 LS resp. ETCS L2 on remaining Corridor A lines not yet confirmed until 2018

7.1.5.3.3.5 Investments

Not specified

7.1.5.4 Switzerland

In the land transport agreement of 21st June 1999, Switzerland committed, among other things, to ensuring that its rail network was interoperable with those of the countries in the European Union. This commitment means that Switzerland must introduce ETCS as the train control, train protection and signalling system and GSM-R as the rail radio system on its standard-gauge network.

7.1.5.4.1 Description of Corridor Lines

In context with the North-South axes through Switzerland (Lötschberg - Simplon respectively Gotthard - Ceneri/Luino) it was agreed with the Corridor A and C countries to implement ETCS. On the North-South axes, ETCS must come into operation at the changeover to the new timetable in December 2015.

On the remaining standard-gauge network, ETCS must come into operation at the changeover to the new timetable in December 2017.

1st objective is the migration of the North-South axes through Switzerland.

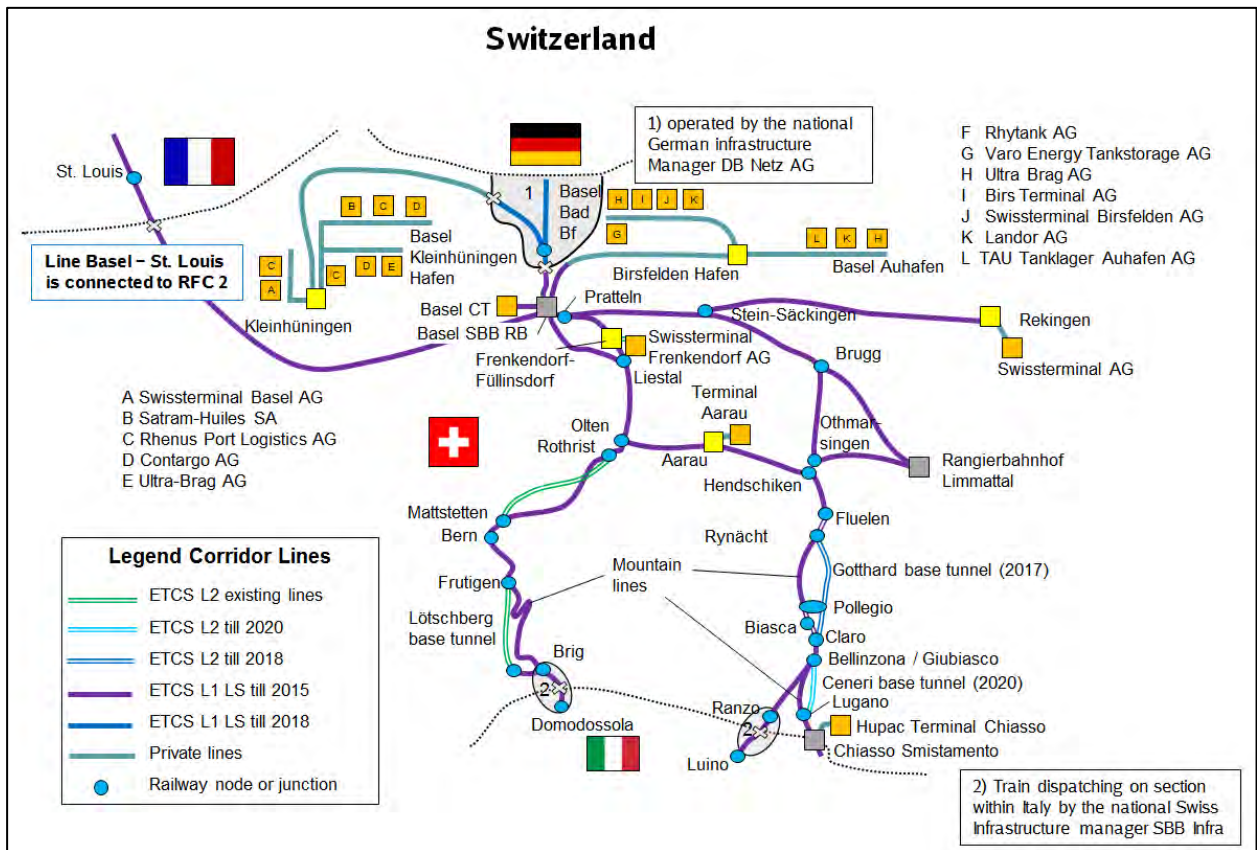

Figure 55: Map of ETCS deployment in Switzerland

Corridor implementation, overview and detailed routes

Figure 56 shows the Corridor A/1 sections from North to South, West Leg (Lötschberg) and East Leg (Gotthard). The map of Switzerland shows the detailed routes and the transition points to the rest of network in Switzerland.

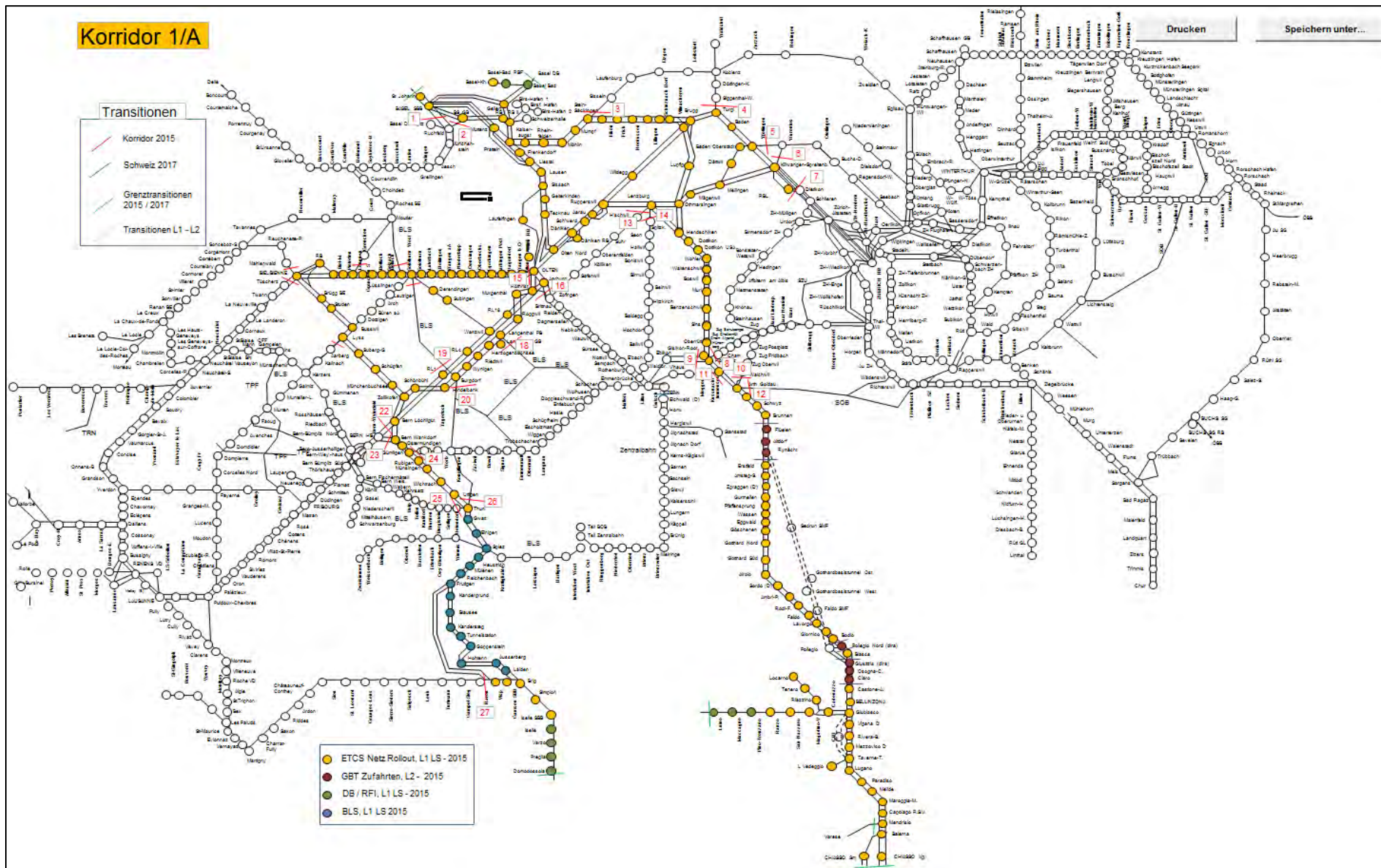

Figure 56: Detailed view of RFC 1 in Switzerland

7.1.5.4.2 ETCS Deployment

7.1.5.4.2.1 Technical Standards, Baseline, Levels

The following sections of the Corridor A/1 are already in service with ETCS Level 2:

- Mattstetten - Rothrist, SRS 2.2.2+
- Lötschberg Base Tunnel, SRS 2.2.2+, will be migrated to 2.3.0d

The Gotthard Base Tunnel – a section of East Leg of Corridor A/1 – will start operation in 2016 with ETCS Level 2

- Gotthard Line, SRS 2.3.0d,
Including the access lines North and South of Gotthard Base Tunnel:
 - Brunnen (excl) - Altdorf - Rynächt (start of operation August 2015),
 - Pollegio Nord - Castione Nord (start of operation October 2015)
 - Giubiasco/S. Antonino (start of operation mid 2018)

All other Corridor A/1 lines will be equipped with ETCS Level 1 LS.

The migration to ETCS consists of replacing the trackside elements SIGNUM and ZUB by ETCS elements (balises) with SIGNUM and ZUB functionality via packet 44 telegrams (EuroSIGNUM/EuroZUB). The balises will also transmit ETCS Level 1 LS information.

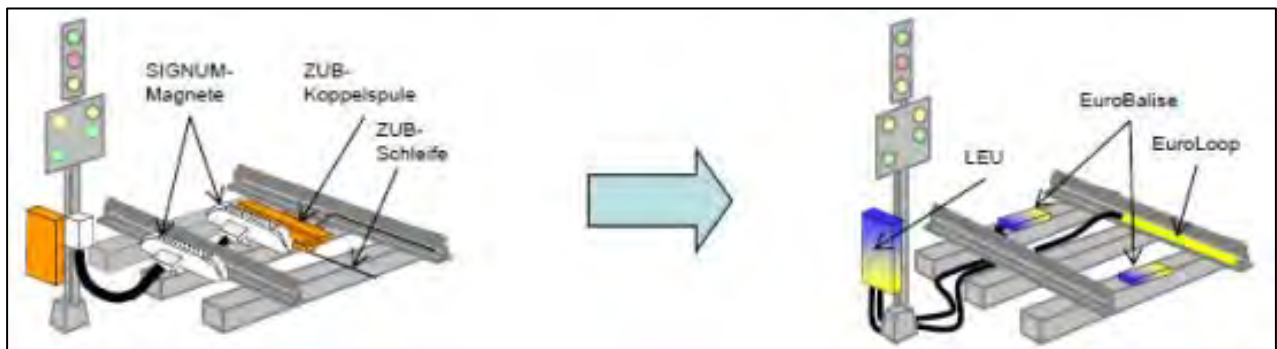

Figure 57: Comparison Signum/Zub and ETCS

This allows, without restrictions, the operation for vehicles equipped with:

- SIGNUM, ZUB, ETM and ETCS Baseline 2.x.x
- SIGNUM, ZUB262ct and ETCS Baseline 2.x.x
- ETCS Baseline 3.x.x

This measure gives the possibility for ETCS-only vehicles (Baseline 3), as well as for vehicles still equipped with SIGNUM- and ZUB-Systems, to run on sections with optical signalling.

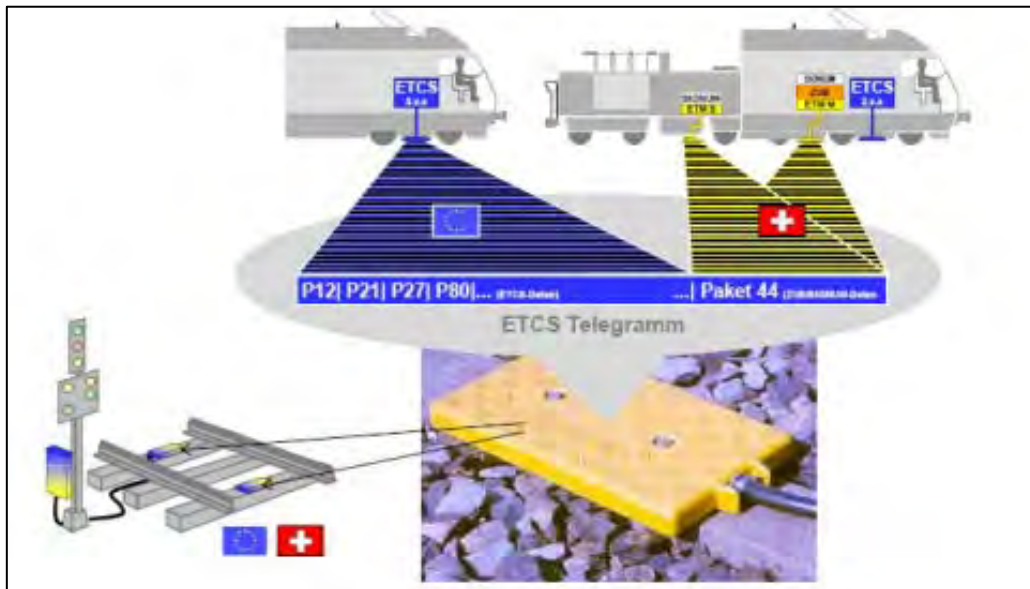

Figure 58: Vehicle operation

Border section Corridor A/1 North

The Basel section up from the Rheinbrücke to Weil am Rhein is planned to be equipped with ETCS Level 1 LS (D) in addition to EuroSIGNUM/EuroZUB (target date December 2015).

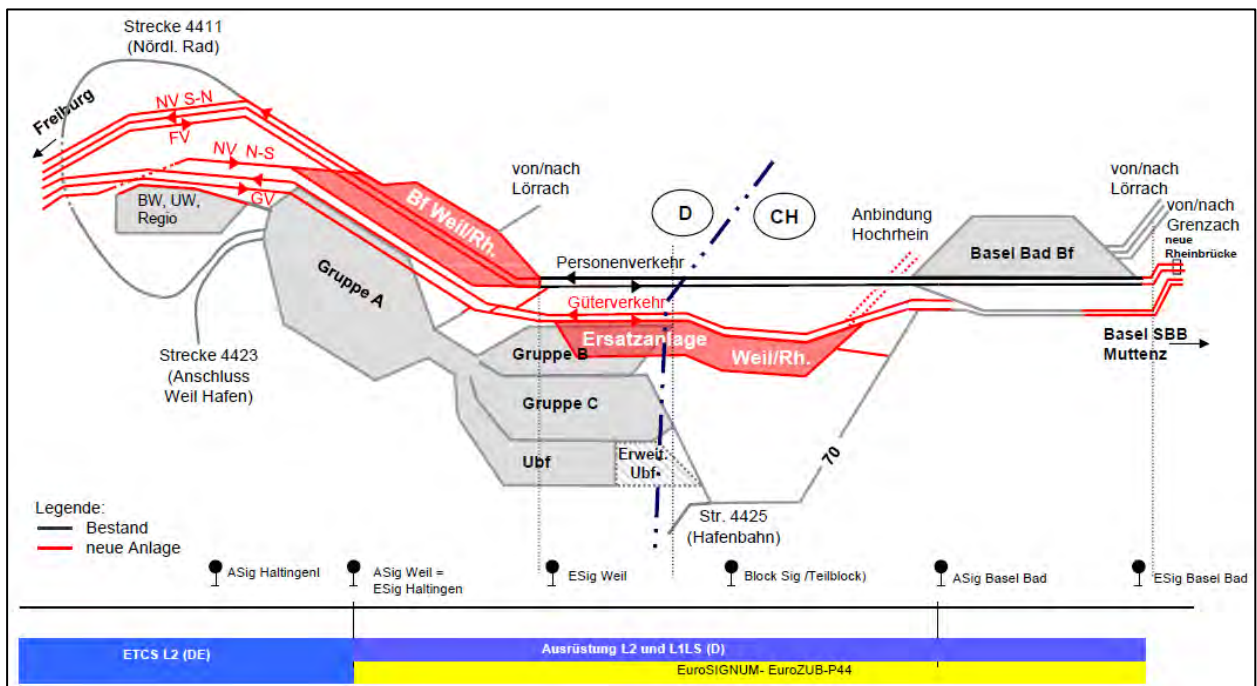

Figure 59: Node of Basel Border section D/CH (SBB)

Border sections Corridor A/1 South

There are 3 border sections on Corridor A at the border Switzerland – Italy:

- Chiasso (CH, infrastructure property of SBB)
- Ranzo (CH) – Luino (IT)
- Brig (CH) - Iselle border – Domodossola (IT)

Remark: Infrastructure within Italian territory is property of by RFI

The sections Ranzo-Luino and Iselle-Domodossola are situated on Italian territory but equipped with Swiss signalling systems. The infrastructure owner, and therefore responsible for the ERTMS-Implementation on this sections, is RFI.

Switzerland has asked Italy for equipping the mentioned sections with EuroSIGNUM/EuroZUB and ETCS Level 1 LS (CH) by December 2015.

The Italian IU RFI will have the responsibility for the construction.

On 3rd August 2012 SBB and RFI signed a MoU, which establishes initial preconditions for this.

7.1.5.4.2.2 Class B Systems in Use

- SIGNUM, ZUB121 or
- EuroSIGNUM, EuroZUB with Packet 44
- And, additionally at the northern border (Basel), we have in parallel the system PZB, up to the next freight/ shunting area.

The life cycle of class B systems in Switzerland is represented below:

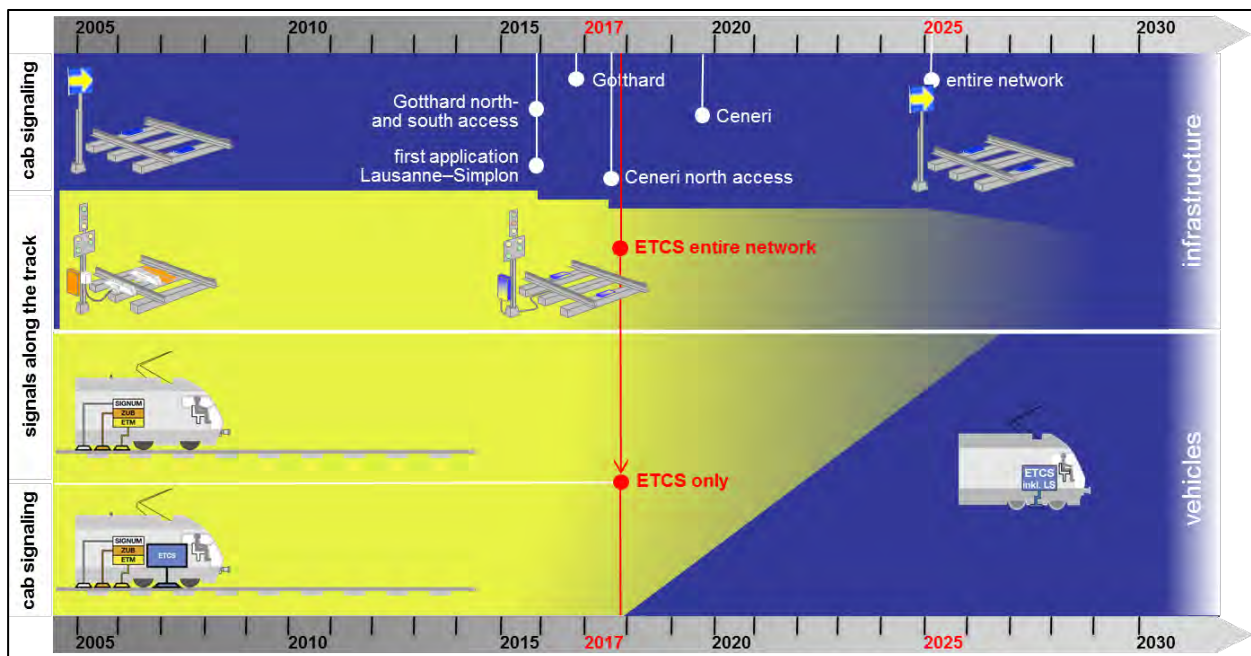

Figure 60: Life cycle of class B systems in Switzerland

7.1.5.4.2.3 National Technical Requirements for Vehicles

The following link leads to the documents of National Requirements and the corresponding generic document which describes the requirements for the operation of ETCS vehicles on ETCS-Lines in Switzerland. The documents are on the official page of the Federal Office of Transport (FoT).

<http://www.bav.admin.ch/grundlagen/03708/03819/03820/index.html?lang=de>

Summary of National Requirements

| ID | Title |
|-----------|---|
| CH01 | Disabling the reading of Eurobalise information (packet 44) by the national train control system ETM/ZUB 262ct before entering a L2 line. |
| CH02 | Enabling the reading of Eurobalise information (packet 44) by the national train control system ETM/ZUB 262ct after leaving a L2 line. |
| CH03 | GSM-R QoS parameters to be fulfilled. |
| CH04 | Traction cut-off on single and multiple units when EB or SB is applied. |
| CH05 | Choice of NL mode in a leading engine must be protected by technical measure. |
| CH06 | Braking curve parameters must fulfil national specifications. |
| CH07 | Required CRs for baseline 2 |
| CH08 | Required tests to get the permission to run on the L2 lines |
| CH09 | The manual selection of L0 in a L2 area must be inhibited by technical measures. |
| CH10 | Vehicles at the front or rear end of a train can be operated in a mode which registers a level transition. |
| CH11 | The train running number of the EVC and GSM-R voice must match. |
| CH12 | Required safety cases |
| CH13 | Brake type to be used in RV-mode; condition to release the brake |
| CH14 | Acceptable train borne safety risk |
| CH15 | Requirements regarding crypto key management |
| CH16 | The ETCS on-board equipment must be capable to read Euroloops. |
| CH17 | On lines not equipped with L2, the ETCS on-board equipment must operate in L0 |
| CH18 | Display of permitted speed in RV-mode. |
| CH19 | Reaction to a balise header with a higher, incompatible system version in RV-mode. |
| CH20 | Number of communication sessions an OBU must be capable to handle simultaneously. |
| CH21 | Securing of correct country specific parameterisation. |
| CH22 | Valid train running number needed to switch from SB mode to FS, UN, SR or OS. |
| CH23 | Prohibition of level STM ZUB/SIGNUM. |
| CH24 | Preclusion of unintended manipulation to the isolation switch. |
| CH25 | Requirements to change to sleeping mode. |
| CH26 | Automatic determination and display of train data for train sets. |
| CH27 | Entry of axle load. |
| CH28 | No reduction of the braking efficiency of a brake application issued by a train control system. |
| CH29 | Necessary resets of a train control system shall not lead to operational constraints. |
| CH30 | Securing of brake means for emergency brake. |
| CH31 | Conditions to be fulfilled to run with speeds > 200 km/h in commercial operation. |
| CH32 | NC_TRAIN for tilting trains |
| CH33 | Possibility to choose a “non tilting train” train category for a tilting train. |
| CH35 | Display of Text Messages |
| CH36 | NC_TRAIN, M_AXLELOAD, V_MAXRAIN |
| CH37 | Acceptance of List of balises in SH area (DC CR 650) |
| CH38 | Trackside availability reporting |

7.1.5.4.2.4 Network Access Conditions

Access conditions for ETCS of IM's BLS and SBB:

On lines equipped with ETCS the train control systems are as well part of infrastructure as of vehicles. To ensure the functionality and overall safety, the performances of the different subsystems have to be adjusted. The following link leads to the official page of the Federal Office of Transport (FoT) which contains all National Requirements and the corresponding generic document which describes the requirements for the operation of ETCS vehicles on ETCS-Lines in Switzerland.

<http://www.bav.admin.ch/grundlagen/03708/03819/03820/index.html?lang=de>

Network Statements of BLS and SBB:

BLS

This Network Statement is published by the BLS Netz AG. It is an integrated contractual component of the track access agreement, and regulates the terms and conditions for using the BLS network. It is designed to enable railway undertakings (RUs) to find the information they require obtaining access to and carrying out their operations on the BLS network.

<http://www.bls.ch/d/infrastruktur/trassen-statement.php>

SBB

This Network Statement is published by the Infrastructure division of Swiss Federal Railways (SBB). It is an integrated contractual component of the track access agreement, and regulates the terms and conditions for using the SBB networks.

Click on the link to see the desired information <http://www.sbb.ch/en/corporation/sbb-as-business-partner/offers-for-rus/onestopshop/basic-information-on-track-access.html>

7.1.5.4.2.5 Testing and Authorisation

Test principles for ETCS:

The master test concept based on the IOP concept for ETCS network access describes and lays down a structure for the test areas needed to achieve a complete, fully functioning, interoperable and integrated ETCS Level 2 system in Switzerland for the Rothrist-Mattstetten/Solothurn line, the Lötschberg base line, the Gotthard base line and the Rhone valley (Pully – Villeneuve, Sion – Sierre).

Click on the link to see the desired

information <http://www.bav.admin.ch/grundlagen/03708/03819/03821/03960/index.html?lang=de>

Authorisation principles for ETCS:

This document describes on a generic level the certificates, safety cases, safety assessments with their mutual dependencies and the involved processes to achieve access to ETCS equipped lines for ETCS equipped vehicles in any particular country.

Click on the link to see the desired

information <http://www.bav.admin.ch/grundlagen/03708/03819/03821/03838/index.html?lang=de>

7.1.5.4.3 ETCS Roll Out Plan

The following table shows the overall implementation of ETCS sections in Switzerland which are so far planned.

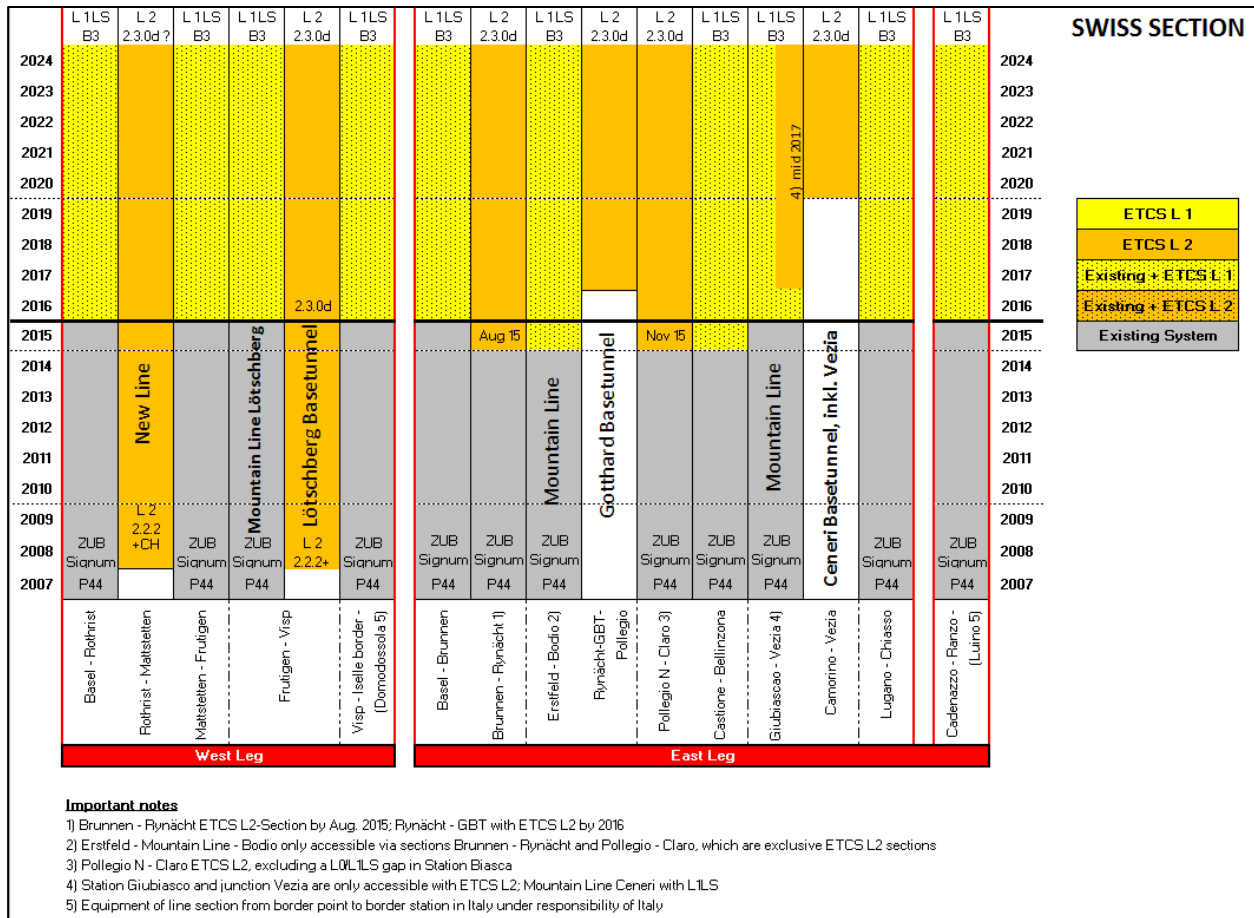

Figure 61: ETCS roll out plan in Switzerland

Remark:

The line section Iselle – Domodossola and the line Ranzo – Luino are within Italian territory and are operated and owned by the Italian infrastructure manager RFI (responsible for migration to ERTMS), the train dispatching is done by the Swiss infrastructure manager SBB.

ETCS L2-lines already in service today on the Corridor A/1 route

- Mattstetten-Rothrist and Solothurn-Wanzwil lines (December 2004)
- Lötschberg-Basetunnel (December 2007)

See Figure 62.

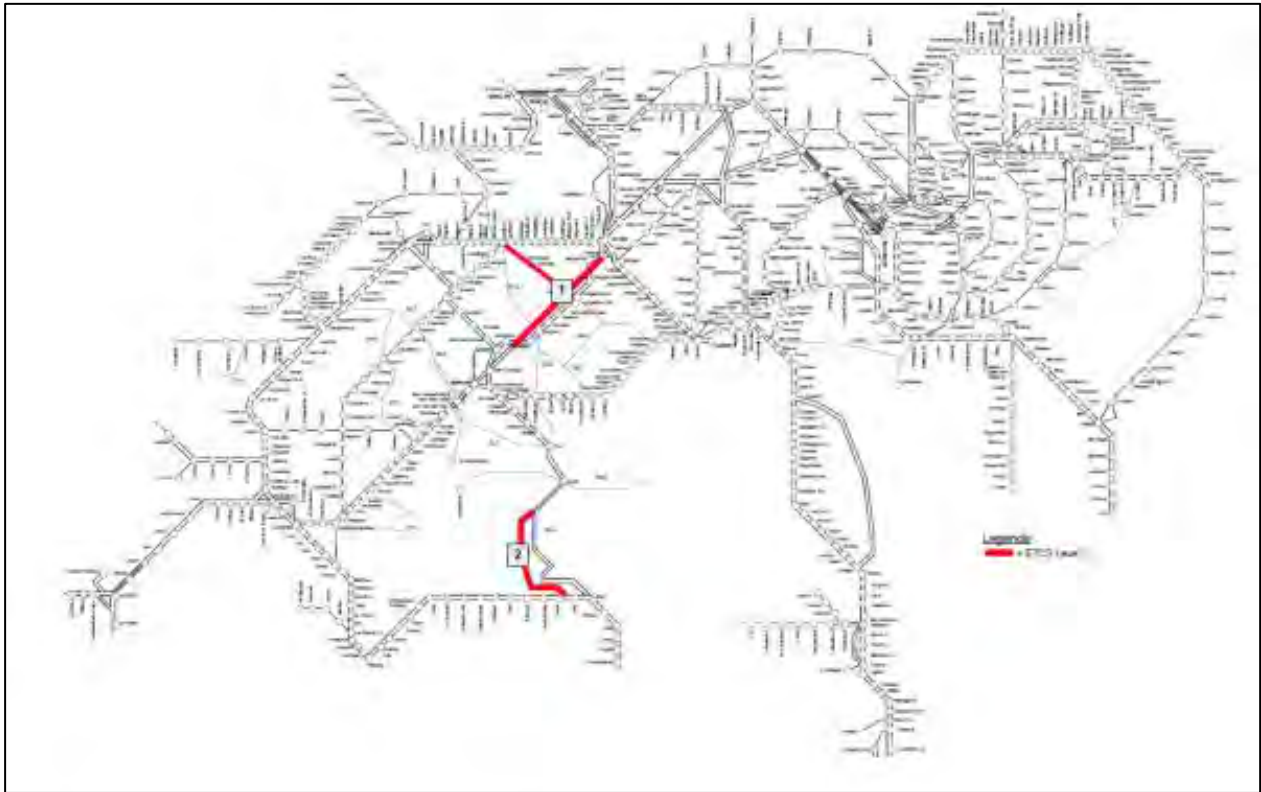

Figure 62: ETCS L2 lines already in service in Switzerland

Phase 1 of further ETCS Rollout on the Corridor A/1 routes

Replacement of ZUB/SIGNUM with EuroZUB/EuroSIGNUM and ETCS Level 1 in mode Limited Supervision (LS) until 2015 (Corridor A/1, North-South) respectively 2017, then the whole normal-gauge network will be migrated to ETCS LEVEL 1 LS.

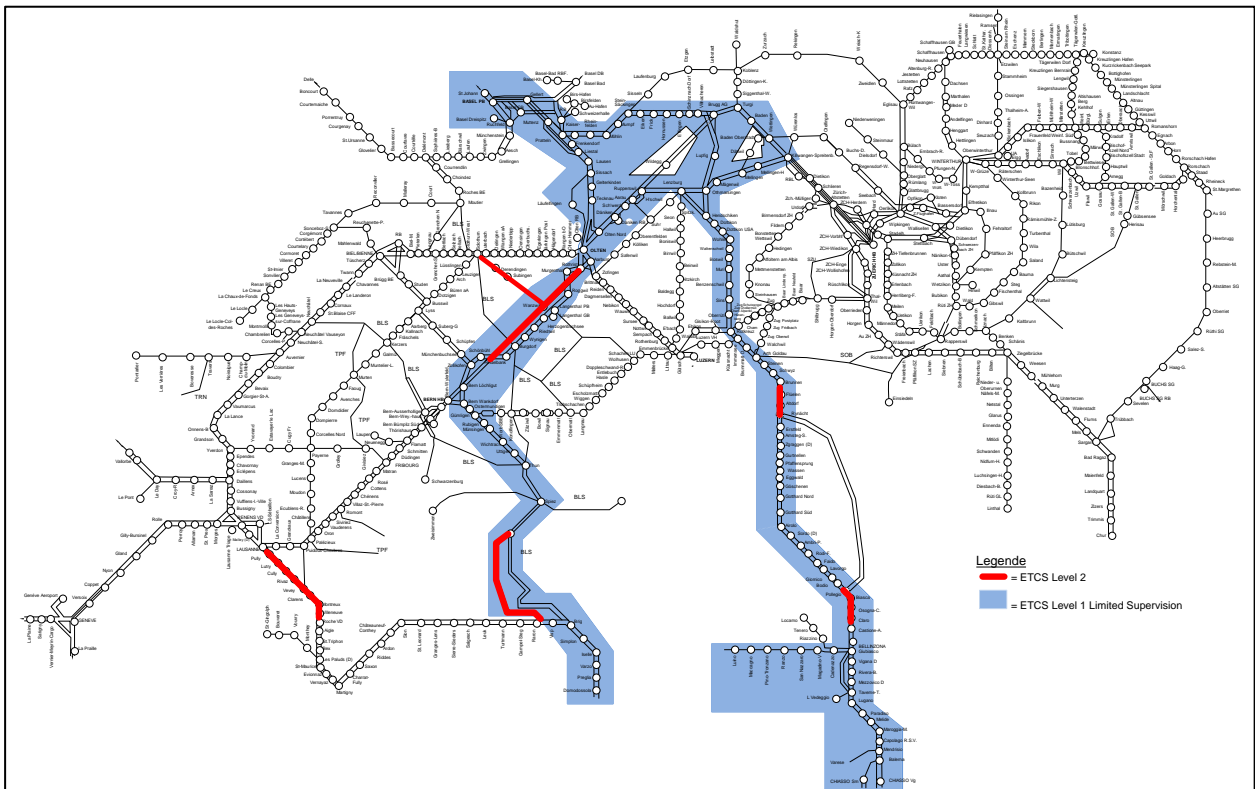

Figure 63: Further ETCS Rollout in Switzerland

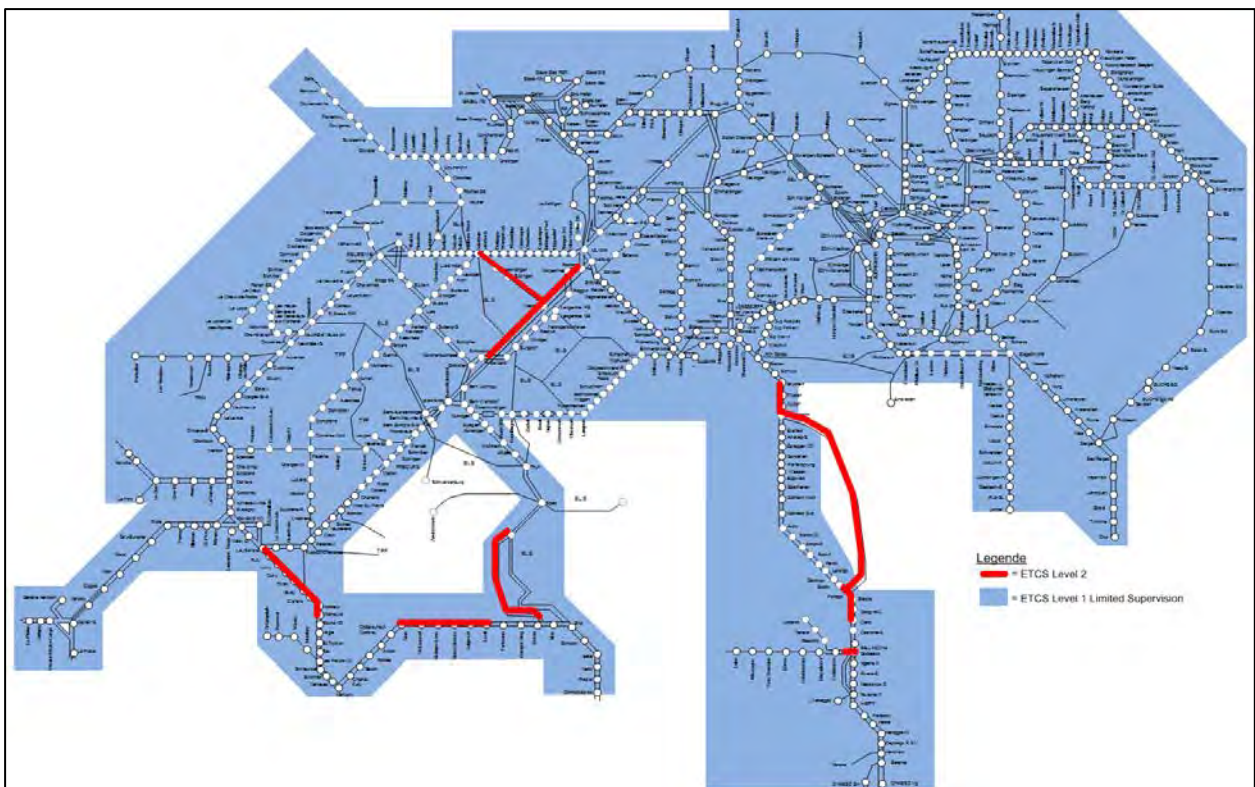

Figure 64: ETCS lines in construction

ETCS Level 2 lines under construction

In August 2011 the Federal Office of Transportation (FoT) informed the railway undertakings about new sections under construction and the future ETCS strategy in Switzerland.

The sections in red are Corridor A/1 sections.

- Gotthard Base Tunnel (in operation December 2016)
- Ceneri Base Tunnel (in operation December 2019)

Including the North and South access sections to the Gotthard Base Tunnel:

- Brunnen (excl.) - Altdorf - Rynächt (in operation August 2015),
- Pollegio Nord - Castione Nord (in operation October 2015),
- Lausanne (excl.) – Simplon, successive by replacement of interlocking's,
- First section Pully - Villeneuve (in operation October 2015).

Also, the following sections are already planned by SBB:

- Sion – Sierre (in operation October 2016),
- Giubiasco/S. Antonino (in operation Mid 2018),
- Roche VD - Vernayaz (in operation 2018-2020),
- Visp – Simplon (in operation 2020).

See also map below.

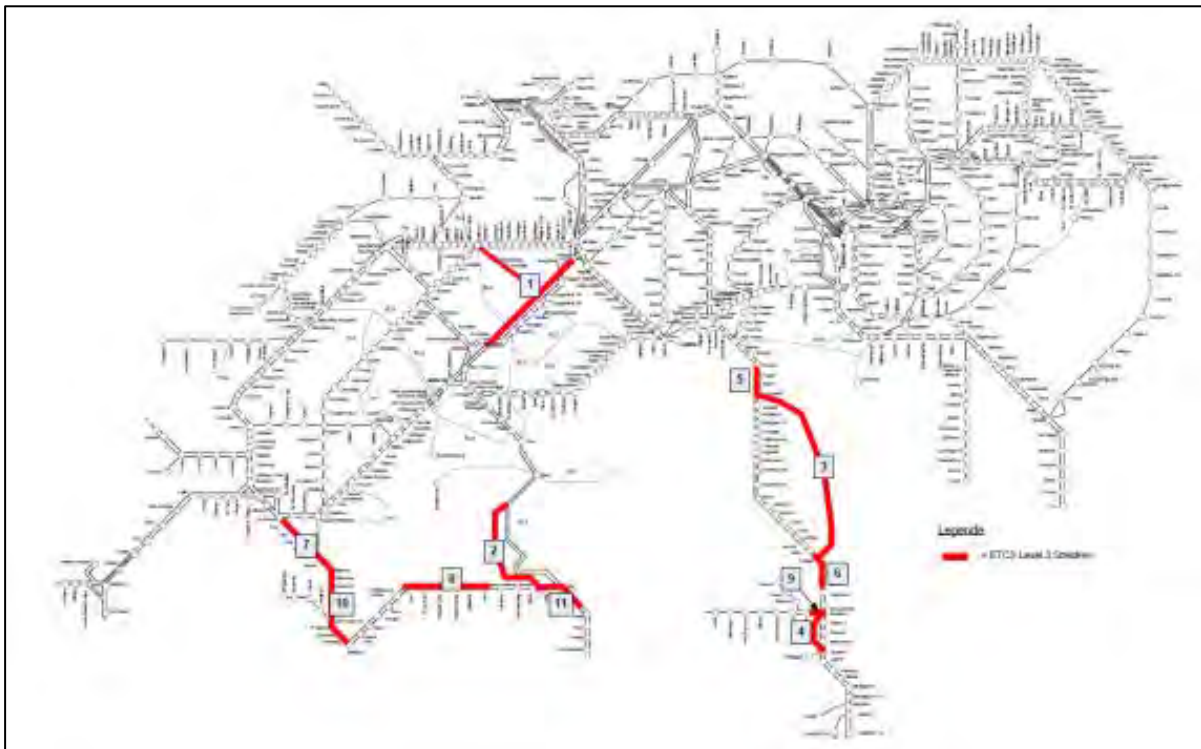

Figure 65: ETCS Level 2 lines under construction

7.1.5.4.3.1 Installation

Level 1 Limited Supervision Rollout-Plan

For the migration to ETCS LEVEL 1 LS BLS and SBB Infrastructure have splitted the network in geographical lots. Figure 66 shows the years of implementation. First priority will be on the North-South axes (Corridor A/1).

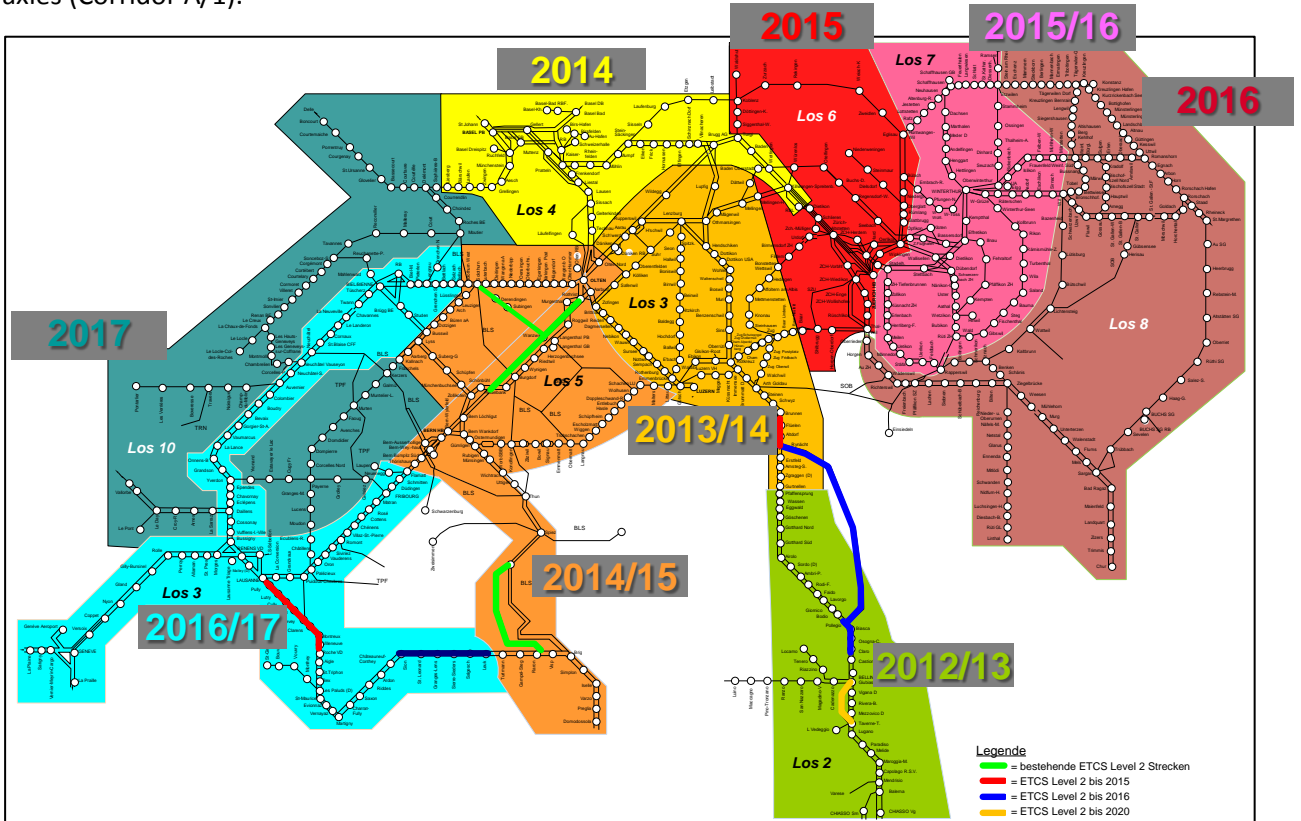

Figure 66: Migration years

2014 Explanation: Lot will be migrated in 2014.

Overview ETCS Level 2 Area on Gotthard-Ceneri axis until 2020

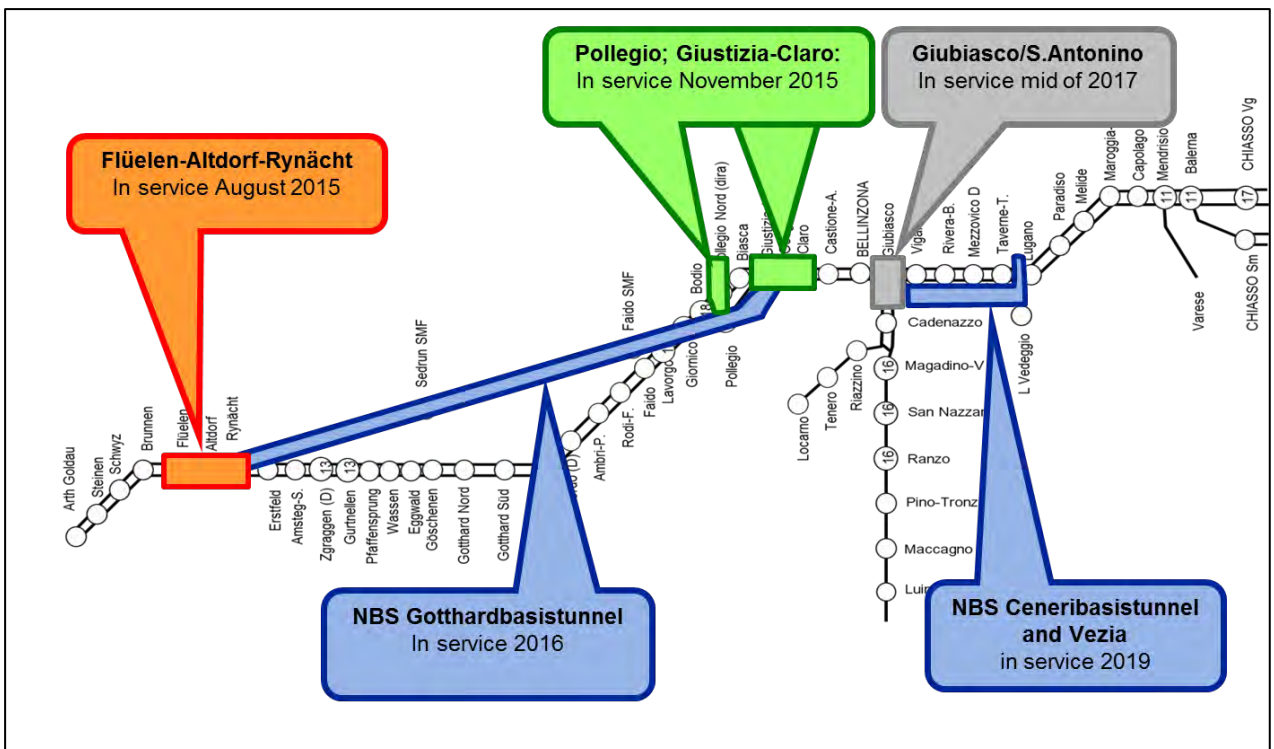

Figure 67: ETCS Level 2 on Gotthard-Ceneri axis

Border Sections North (Basel) and South (Chiasso, Luino and Domodossola)

Sections are in responsibility of the neighbouring infrastructure managers DB Netz and RFI.

7.1.5.4.3.2 Testing and Putting in Service

See above sections.

7.1.5.4.3.3 Detailed Description of ETCS Equipment on Swiss Part of Border Sections Switzerland - Italy

On the border sections several operational and technical changes between national infrastructures take place. Technical installations and procedures are arranged to secure the best possible migration for the railway undertakings. ETCS has to consider this as it is only one feature in this process and e. g. connected with electric power supply, communications systems or the operational language.

In Switzerland the electric power system is operated with a voltage of 15 kV alternating current whereas the Italian railway network is electrified with 3kV direct current.

Catenary powerless sections are necessary to divide the Swiss catenary network (15kV AC) from the Italian catenary network (3kV DC).

In the Corridor A/1, the railway networks of Switzerland and Italy are connected by the following border sections. For all three lines in the frame of the European Deployment Plan, equipment with ETCS is foreseen:

- a) Brig (CH) – Domodossola (IT)
- b) Ranzo (CH) – Luino (IT)
- c) Chiasso (CH) – Monte Olimpino / Monte Olimpino II (IT)

Within Swiss territory the infrastructure is property of SBB, within Italian territory it is the property of RFI. Transition points on the border-crossing lines are defined in special bilateral agreements. The main principle of an operational change in a border train station shall be kept in the future and taken into consideration for ETCS-installation.

In this chapter only the border section Chiasso – Como S. Giovanni will be described, because the border/changeover station is situated in Switzerland, whereas the description of Brig (CH) – Iselle (I) – Domodossola (I) and Ranzo (CH) – Luino (I) can be found under chapter 7. 1.5.5.3.3 Detailed Description of ETCS Equipment on Italian Part of Border Sections CH – IT.

ETCS L1 LS (CH) means: ETCS L1 LS with Swiss specific engineering rules.

c) Chiasso - Monte Olimpino / Monte Olimpino II (IT)

| Line name/ -number | station / part of station / border point | | | | km | |
|-----------------------------------|--|-----|-----------|----|---------|---------|
| | from | to | from | to | | |
| 600 Mendrisio-Chiasso Viaggiatori | Track | 922 | Track 839 | | 206.400 | 206.500 |
| 639 Balerna-Chiasso Smistamento | | | | | | |

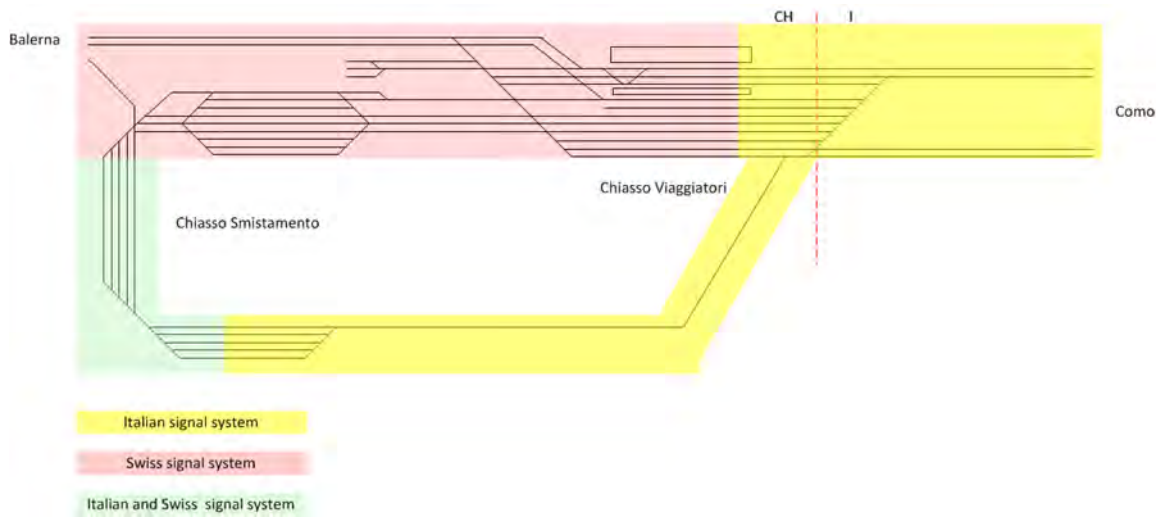

Figure 68: Installation of signalling systems at Chiasso (SBB)

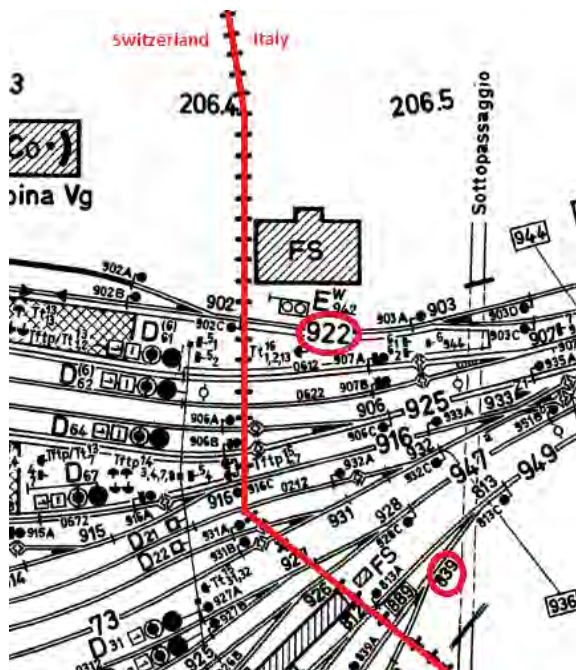

Figure 69: State border at Chiasso station

Currently important line properties

- Electrification
 - Change of electric power supply (catenary):
 - From the Swiss side the catenary has 15kV AC
 - From the Italian side the catenary has 3kV DC
 - The areas where only trains with Italian traction can move are indicated in dark blue
 - The areas where only train with Swiss traction can move are indicted in green
 - The areas where both can move are indicated in light blue

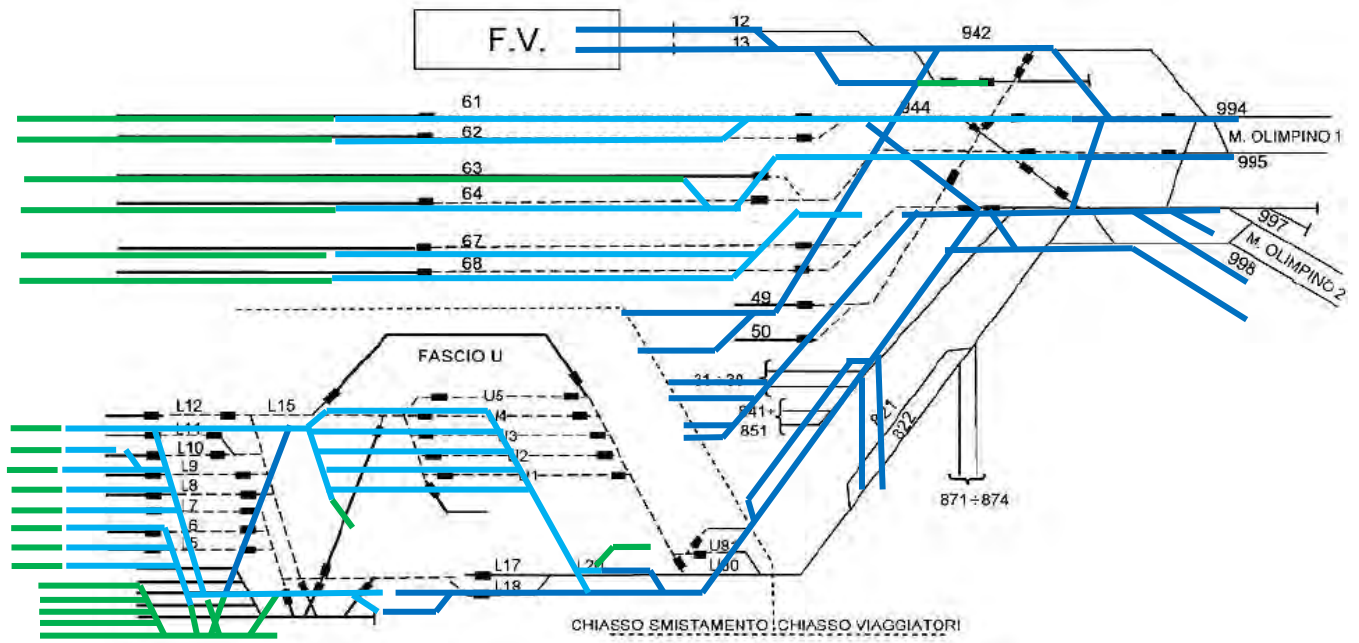

Figure 70: Operational handover at Chiasso

The following figure shows the border between the Swiss interlocking and the Italian interlocking

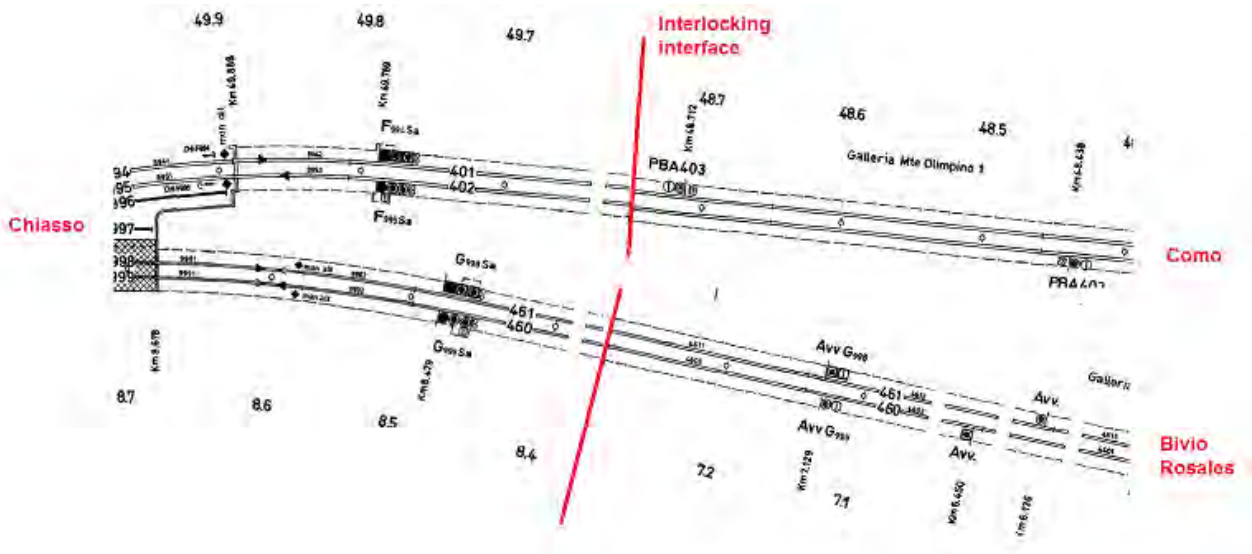

Figure 71: Interlocking interface at Chiasso's border section

- Communication system: GSM-R
- Control and signalling systems:
 - Swiss Class B System SIGNUM
 - Implementation of Italian Class B system SCMT until 2015
 - Implementation of ETCS L1 LS (CH) on the Swiss signals by 2015.
- Lingua franca: italian
- Operational management: SBB Infra
- Responsible for the equipment: SBB Infra on Swiss part, RFI on Italian part.
- The following equipment will be implemented
 - ETCS L1 LS (CH) on Swiss signals
 - The implementation of ETCS technology on the complete node/line, especially also on Italian side, is still subject of clarification!

- o ETCS L1 (IT) on Italian signals (as soon as the Italian engineering rules are available and approved)

Borders

The following figure shows the different borders between Switzerland and Italy.

The network connections points are located in the tunnel entrances: Monte Olimpino I km FFS 207.044 / FS 49.884 (Line direction Como S.G.) and Monte Olimpino II km FFS 206.892 / FS 8.777 (Line direction Bivio Rosales). In relation to the infrastructure, belongs to SBB all needed installations for train operations located in the south part of Chiasso station which are in the Italian territory up to the network connection points. The contracts states, in relation with the safety installations, that the entrance signals at station Chiasso, the ones which are located in the tunnels MO I (km FS 49.789) resp. MO II (km FS 8.479), are maintained by SBB-Infrastruktur.

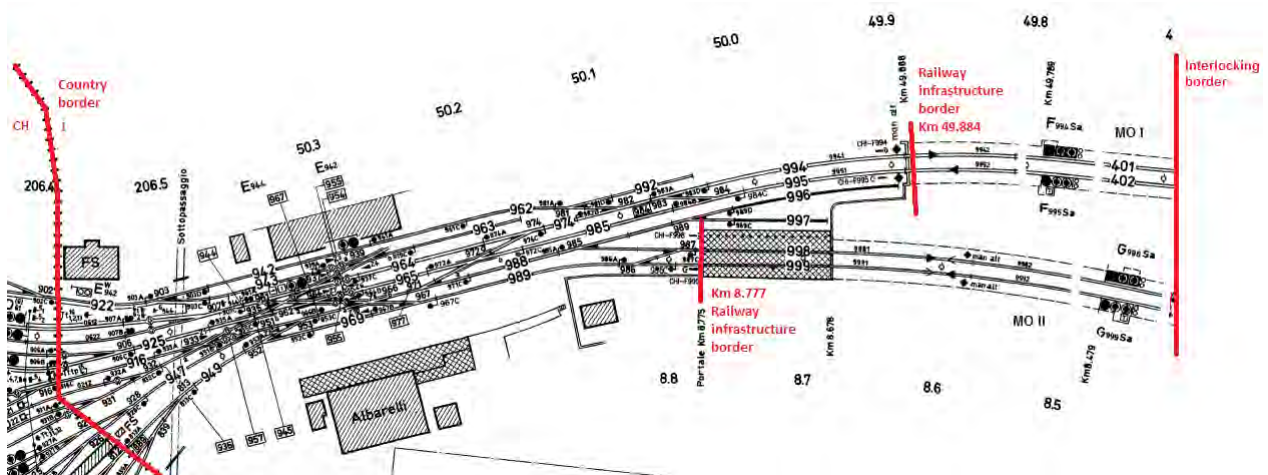

Figure 72: Change of infrastructure properties with regard to an ETCS-Equipment

Current and future situation

The interlocking system of Chiasso Station is part of the SBB Infrastruktur network. This interlocking system partly controls the infrastructure on Swiss territory where the Federal Office of Transportation (FOT) is responsible for safety, and partly controls infrastructure on Italian territory (entry signals from Monte Olimpino I and II) under ANSF's responsibility.

The following projects are planned for Chiasso:

- Implementation of the SCMT, EuroSIGNUM/ZUB, ERTMS L1 LS;
- Implementation of a new electronic Interlocking system (2018);
- Implementation of transitions ERTMS ETCS Level 2 ITA <-> ERTMS ETCS Level 1 LS CH

7.1.5.4.3.4 Investments

The investment costs (in CHF) for ETCS (trackside only) on the corridor lines are 517 Mio. The figures include a pilot line (in operation 2002-2003 only), the L2- and Level 1 LS-Sections and the border sections. GSM-R is not included.

For detailed information see the annual ETCS-Report of FoT.

Link: <http://www.bav.admin.ch/dokumentation/publikationen/00568/00570/01501/index.html?lang=d>
e

7.1.5.5 Italy

7.1.5.5.1 Description of Corridor Lines

The ERTMS deployment plan relevant to the Italian line sections designated to be part of Rail Freight Corridor 1 is basically driven by the obligations deriving from the TSI CCS (EDP) presently in place.

However, some adjustments in the time planning of ERTMS deployment are proposed in order to ensure a harmonized corridor implementation. In fact, only continuous trackside ERTMS coverage along the principal European lines will create the necessary incentives for train operating companies to invest in onboard ERTMS equipment.

The corridor lines (principal and diversionary lines) of the Italian part of with obligation for ERTMS implementation as required by TSI CCS (EDP) are presented in the figure below, where the red color represents a time horizon up to 2015 and the blue the time horizon of 2020.

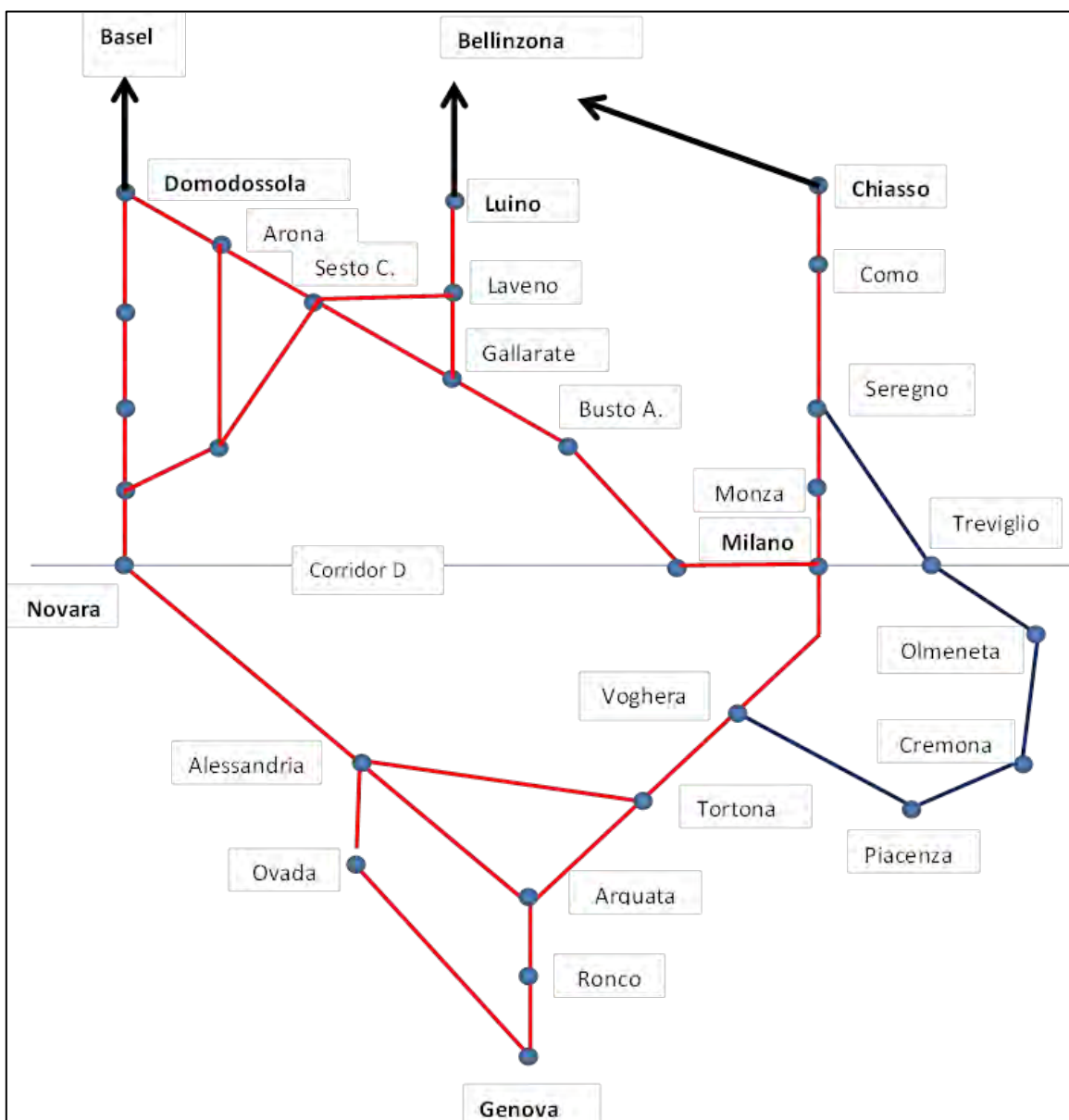

Figure 73: ERTMS corridor lines in Italy according to TSI CCS (EDP)

A revised time planning notified to the Commission by the Italian Ministry of Transport in compliance with art.7.3.2.5 of TSI CCS foresees changes mainly due to the financial restrictions and to the need of

ensuring a harmonized and synchronized ERTMS corridor implementation. In fact, only continuous trackside ERTMS coverage along the principal European lines will create the necessary incentives for train operating companies to invest in onboard ERTMS equipment. Such revised time planning is still under negotiation between the Member State and the Commission and maybe subject to significant changes. The new planning is shown in Figure 77.

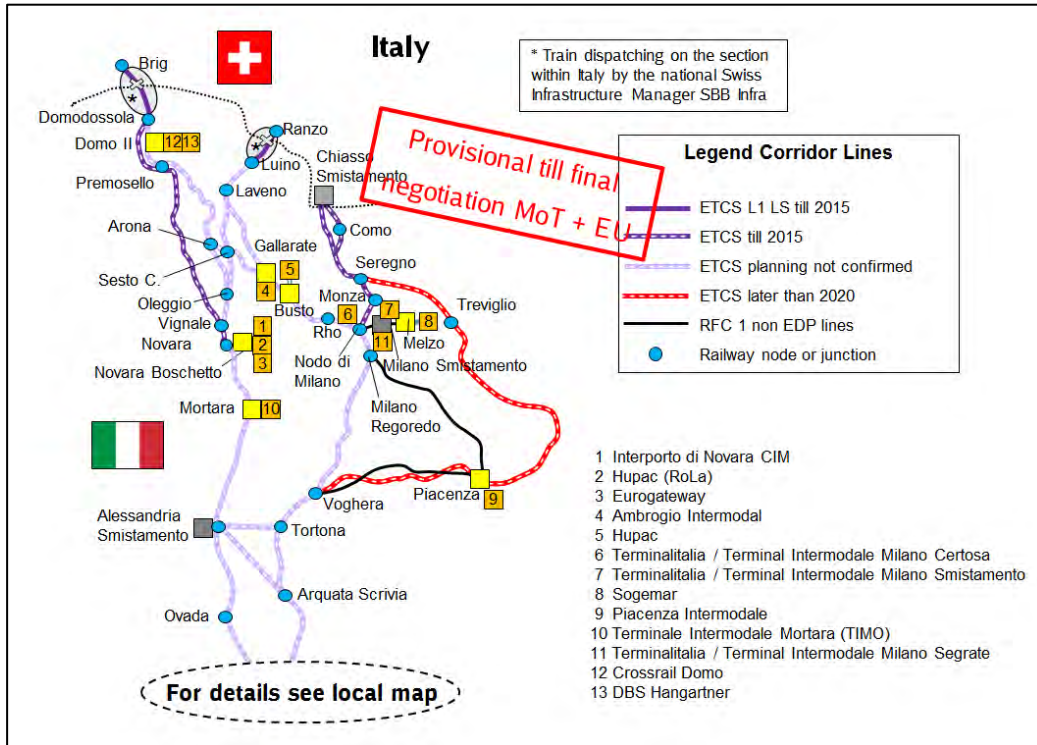

Figure 74: Current planning ERTMS corridor lines in Italy according to TSI CCS (EDP) (see also 7.1.5.5.3 ETCS Roll Out Plan)

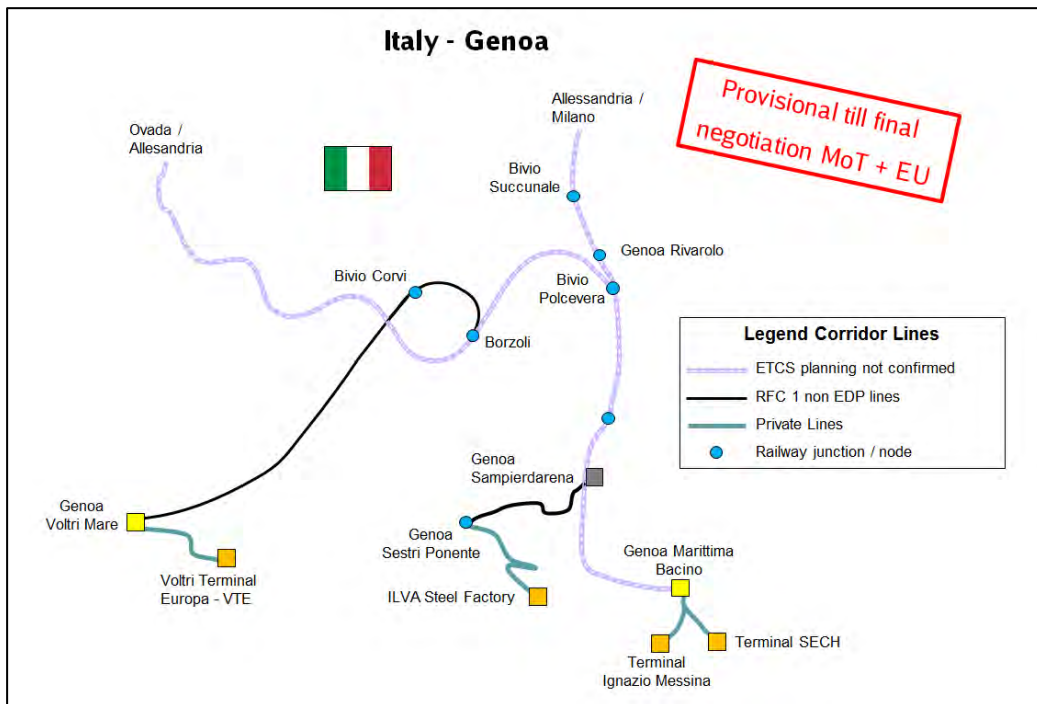

Figure 75: Current planning ERTMS corridor lines in Italy according to TSI CCS [EDP (detail Genoa)]

ERTMS implementation in the hubs of Novara, Milano and Genova (with limitation to the node internal routings utilised for the connection between freight areas and corridor designated lines) is planned for 2015.

7.1.5.5.2 ETCS Deployment

7.1.5.5.2.1 Technical Standards, Baseline, Levels

The technical standard foresees everywhere the superposition of ERTMS to the existing legal Class B systems. The choice of the ERTMS Level on the different sections of the Corridor will be made on the basis of two criteria. The first one is based on the Control Command System in use. On lines with existing SCMT + BACC, that mean a continuous Control Command System, ERTMS Level 2 will be implemented.

On lines with SCMT Stand Alone, that means a discontinuous Control Command System it will be applied a second criteria based on an evaluation about:

- Costs
- Performances
- Maintenance

On the basis of the mentioned criteria it will be possible to have two ERTMS Level implementations:

- Level 1 + Infill Radio;
- Level 2

The ERTMS Baseline implemented Trackside will be for the Level 2 the Baseline 2 (as specified for the Version 1.1 in the Baseline 3) and for the Level1 plus Infill Radio the Baseline 3 (to take advantage from the optimised functionality specified for the Infill by Radio).

7.1.5.5.2.2 Class B Systems in Use

- SCMT – Stand alone
- SCMT + BACC

For both the existing installations of such Class B systems it is already applied trackside the technology and the coding strategy (Pk44) of the European standard Eurobalise.

7.1.5.5.2.3 National Technical Requirements for Vehicles

- An On Board/Trackside Integration Safety Case is requested for the authorisation to place in service vehicles.
- For national requirements for vehicles authorisation see ERA Cross Acceptance Unit and the Italian ANSF. Ref. ERA/TD/2011-01/XA v.1.0 date 07/07/2011.

7.1.5.5.2.4 Network Access Conditions

- All the trains have to be equipped with ETCS or Class B system in use. Running in Level 0 is inhibited.
- ETCS trains have to implement the Braking Curve model defined in the Baseline 3.
- ETCS trains have to implement On Board the Optimised radio infill function (CR 742) as defined in Baseline 3.
- ETCS trains have to be equipped with two GSM/R mobile terminals to manage transition between neighbouring RBCs, RIUs, and RBCs and RIUs borders.

7.1.5.5.2.5 Testing and Authorisation

The test and authorisation process for sections of Corridor A will be organised in a way that the authorisation of vehicles for operation on Corridor A will be facilitated.

This includes the following provisions to be fulfilled by the manufacturer of the trackside ETCS equipment:

- 1) The manufacturer has to provide the track description, engineering data and track-train system validation test cases for the implementation of the contracted trackside ETCS equipment in accordance to a common standard, based on subset-110,111,112.
- 2) The manufacturer has to provide all test cases that are required to prove safe and interoperable operation under the specific conditions of this ETCS infrastructure system. The test cases shall meet the specified operational conditions in combination with on-board CCS subsystems certified to comply with the European standard.
- 3) For this purpose, the infrastructure manager will provide a set of operational test scenarios in European standardised format that cover the operation of ETCS on the Corridor. The manufacturer has to demonstrate that these operational test scenarios are fully covered by his tests. Any deviation has to be agreed with the infrastructure manager.
- 4) The manufacturer has to use a laboratory test environment according to the principles of UNISIG subset 110, 111, 112.
- 5) On request of the infrastructure manager, the manufacturer has to perform track-train system validation tests with on-board units of at least 1 different supplier.
- 6) The laboratory tests shall be performed using the above mentioned track description and engineering data together with, for Level 2 sections, the real RBC hardware and software version.
- 7) For the purpose of authorisation of rolling stock, the trackside manufacturer has to provide the laboratory test environment including technical support for tests with on-board units of railway undertakings that apply for authorisation on the Corridor.
- 8) If necessary, the manufacturer has to cooperate in field tests and test result analysis that have to be performed with ETCS vehicles of railway undertakings for their authorisation on the Corridor.
- 9) Before placing in operation the trackside equipment, on request of the infrastructure manager, the manufacturer has to support cross field tests with vehicles of different suppliers.

7.1.5.5.3 ETCS Roll Out Plan

The table below shows the overall implementation of ETCS sections in Italy which are so far planned (Provisional until final negotiation MoT + EU)

| Year | L2/B2 L1/B3 | | | L2/B2 L1/B3 | | | | | L2/B2 L1/B3 | | | L2/B2 L1/B3 | | | L2/B2 L1/B3 | | | Year | |
|--|-----------------|-----------------|---|-----------------|-----------------|-----------------|-----------------|--|-----------------|-----------------|---|-----------------|-----------------|---|-----------------|-----------------|---|------|--|
| | SCMT | SCMT | SCMT | SCMT | SCMT | SCMT | SCMT | SCMT | SCMT | SCMT | SCMT | SCMT | SCMT | SCMT | SCMT | SCMT | SCMT | | |
| 2024 | Existing System | Existing System | Existing System | Existing System | Existing System | Existing System | Existing System | Existing System | Existing System | Existing System | Existing System | Existing System | Existing System | Existing System | Existing System | Existing System | Existing System | 2024 | |
| 2023 | Existing System | Existing System | Existing System | Existing System | Existing System | Existing System | Existing System | Existing System | Existing System | Existing System | Existing System | Existing System | Existing System | Existing System | Existing System | Existing System | Existing System | 2023 | |
| 2022 | Existing System | Existing System | Existing System | Existing System | Existing System | Existing System | Existing System | Existing System | Existing System | Existing System | Existing System | Existing System | Existing System | Existing System | Existing System | Existing System | Existing System | 2022 | |
| 2021 | Existing System | Existing System | Existing System | Existing System | Existing System | Existing System | Existing System | Existing System | Existing System | Existing System | Existing System | Existing System | Existing System | Existing System | Existing System | Existing System | Existing System | 2021 | |
| 2020 | Existing System | Existing System | Existing System | Existing System | Existing System | Existing System | Existing System | Existing System | Existing System | Existing System | Existing System | Existing System | Existing System | Existing System | Existing System | Existing System | Existing System | 2020 | |
| 2019 | Existing System | Existing System | Existing System | Existing System | Existing System | Existing System | Existing System | Existing System | Existing System | Existing System | Existing System | Existing System | Existing System | Existing System | Existing System | Existing System | Existing System | 2019 | |
| 2018 | Existing System | Existing System | Existing System | Existing System | Existing System | Existing System | Existing System | Existing System | Existing System | Existing System | Existing System | Existing System | Existing System | Existing System | Existing System | Existing System | Existing System | 2018 | |
| 2017 | Existing System | Existing System | Existing System | Existing System | Existing System | Existing System | Existing System | Existing System | Existing System | Existing System | Existing System | Existing System | Existing System | Existing System | Existing System | Existing System | Existing System | 2017 | |
| 2016 | Existing System | Existing System | Existing System | Existing System | Existing System | Existing System | Existing System | Existing System | Existing System | Existing System | Existing System | Existing System | Existing System | Existing System | Existing System | Existing System | Existing System | 2016 | |
| 2015 | Existing System | Existing System | Existing System | Existing System | Existing System | Existing System | Existing System | Existing System | Existing System | Existing System | Existing System | Existing System | Existing System | Existing System | Existing System | Existing System | Existing System | 2015 | |
| 2014 | Existing System | Existing System | Existing System | Existing System | Existing System | Existing System | Existing System | Existing System | Existing System | Existing System | Existing System | Existing System | Existing System | Existing System | Existing System | Existing System | Existing System | 2014 | |
| 2013 | Existing System | Existing System | Existing System | Existing System | Existing System | Existing System | Existing System | Existing System | Existing System | Existing System | Existing System | Existing System | Existing System | Existing System | Existing System | Existing System | Existing System | 2013 | |
| 2012 | Existing System | Existing System | Existing System | Existing System | Existing System | Existing System | Existing System | Existing System | Existing System | Existing System | Existing System | Existing System | Existing System | Existing System | Existing System | Existing System | Existing System | 2012 | |
| 2011 | Existing System | Existing System | Existing System | Existing System | Existing System | Existing System | Existing System | Existing System | Existing System | Existing System | Existing System | Existing System | Existing System | Existing System | Existing System | Existing System | Existing System | 2011 | |
| 2010 | Existing System | Existing System | Existing System | Existing System | Existing System | Existing System | Existing System | Existing System | Existing System | Existing System | Existing System | Existing System | Existing System | Existing System | Existing System | Existing System | Existing System | 2010 | |
| 2009 | Existing System | Existing System | Existing System | Existing System | Existing System | Existing System | Existing System | Existing System | Existing System | Existing System | Existing System | Existing System | Existing System | Existing System | Existing System | Existing System | Existing System | 2009 | |
| 2008 | Existing System | Existing System | Existing System | Existing System | Existing System | Existing System | Existing System | Existing System | Existing System | Existing System | Existing System | Existing System | Existing System | Existing System | Existing System | Existing System | Existing System | 2008 | |
| 2007 | Existing System | Existing System | Existing System | Existing System | Existing System | Existing System | Existing System | Existing System | Existing System | Existing System | Existing System | Existing System | Existing System | Existing System | Existing System | Existing System | Existing System | 2007 | |
| Domo - Novara | | | Novara - Genoa | | | | | Chiasso - Milano - Arquata - Genova | | | Luino - Vignale | | | Domo - Rho | | | Seregno - Voghera | | |
| Domodossola - Premossello - Premossello - Bergom. - Vignale - Vignale - Novara | | | Novara - Alessandria - Alessandria - Ovada - Ovada - Genova - Alessandria - Arquata - Alessandria - Tortona | | | | | Chiasso - Como - Como - Seregno - Seregno - Milano - Milano - Voghera - Tortona - Tortona - Arquata - Arquata - Genova | | | Luino - Laveno - Gallarate - Laveno - Sesto Calende - Oleggio - Oleggio - Vignale | | | Domodossola - Arona - Oleggio - Arona - Sesto Calende - Sesto Calende - Gallarate - Busto Arsizio - Rho | | | Seregno - Treviglio - Olmeneta - Olmeneta - Cremona - Piacenza - Piacenza - Voghera | | |

Existing System ETCS L 1 Existing + ETCS L 1 Existing + ETCS L 2 Existing + ETCS L 1/L 2

ETCS in planning ETCS L 2

Figure 76: ETCS roll out plan in Italy

7.1.5.5.3.1 Installation

Pending on the outcomes of the negotiations between EC and Italy RFI has planned to implement ERTMS by the end of 2015 on the two main routes of the national part of the Corridor limited to the following sections:

- Chiasso – Milano – Tortona – Genova
- Domodossola – Borgomanero – Novara

The other sections of the Corridor, to be equipped originally by the end of 2015, will be realised by the end of 2020, except for the section Seregno – Voghera (via Treviglio – Cremona – Piacenza).

The above mentioned program will allow by the end of 2015 an interoperable traffic with the Switzerland network. To achieve this target Italy has already signed with the Switzerland a Memorandum of Understanding for the equipment with both the Class A and B Control Command Systems over the stations on the borders between the Countries and to planning the development of the ERTMS Level 2 on the priority line Milano – Chiasso.

7.1.5.5.3.2 Testing and Putting in Service

See chapter 7.1.5.5.2.5 Testing and Authorisation

7.1.5.5.3.3 Detailed Description of ETCS Equipment on Italian Part of Border Sections Switzerland - Italy

In the Corridor, the railway networks of Switzerland and Italy are connected by the following border sections. For all three lines in the frame of the European Deployment Plan, equipment with ETCS is foreseen:

- a) Iselle – Domodossola - Domodossola 2, 2015
- b) Ranzo– Luino, 2015
- c) Chiasso, 2015

In order to document the interoperability target, on August 2012 a Memorandum of Understanding (MoU) was signed by RFI's and SBB-I's CEOs. The purpose of this MoU is to identify the roles and responsibilities of each party as they relate to the implementation of Train Control Systems at the border between Italy and Switzerland.

Within Swiss territory the infrastructure is property of SBB, within Italian territory it is the property of RFI. Transition points on the border-crossing lines are defined in special bilateral agreements. The main principle of an operational change in a border train station shall be kept in the future and taken into consideration for ETCS-installation.

In this chapter only the border sections Brig (CH) - Iselle – Domodossola (I) and Ranzo (CH) – Luino (I) will be described, because the border/changeover station is situated in Italy, whereas the description of Chiasso – Como S. Giovanni can be found under chapter “7.1.5.4.3.3 Detailed Description of ETCS Equipment on Swiss Part of Border Sections Switzerland - Italy”.

a) Brig (CH) - Iselle – Domodossola (IT)

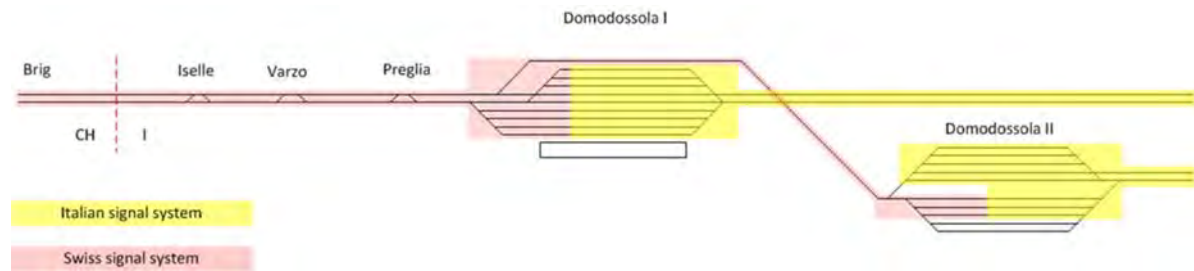

Figure 77: Installation of signalling system on border section Brig – Domodossola I and II

| Line name/ -number | station / part of station / border point | | km | |
|-----------------------|--|-------------|---------------|-----------|
| | from | to | | |
| 145 | Brig | Domodossola | 145.55/167.22 | 19.06/0.0 |

Country borders

The country border is located in the middle of the Simplon tunnel in the area of the tunnel station at km SBB 156.231. The tunnel station extends from km SBB 155.846 to km SBB 156.827 and enables the trains to change from tunnel tube I to tunnel tube II. The country border has no direct impact on the signaling and the safety systems. In context with the “Simplon license” SBB operates as well the half of the tunnel on the Italian territory up to the network connection point in Iselle at km SBB 167.077 and remains integral responsible for the entire infrastructure.

Border infrastructure

The network connection point between the infrastructures of SBB and RFI is located at the entrance on side Switzerland of the Galleria di Iselle (also called Sempioncino) at km FS 19.200, resp. km SBB 167.077 on Italian territory. The border of the safety installations is defined as follows: The last single connection point 11a-11b of the railway station Iselle on the Simplon side with the isolated track circuits belongs to the RFI-network; the axle counters at km FS 19.204 belong to the SBB-network. The entry signals of the railway station Iselle K_I km SBB 166.578 resp. K_{II} km SBB 166.668 belong to the SBB-network, the exit signals of the railway station Iselle B – E km FS 18.841 – 18.905 in direction Simplon belong to the RFI-network.

Traction power

Catenary powerless sections are necessary to divide the Swiss catenary network (15 kV AC) from the Italian catenary network (3 kV DC).

Trains to and from Switzerland lowers the pantograph and moves in inert state.

The northern part of track no. 1 at Domodossola is switchable between 15 kV AC and 3 kV DC to guarantee the access to tracks which are equipped with 3 kV DC.

Currently important line properties

- Operational handover stations: Domodossola I (RFI), Domodossola II (RFI)
- Communication system: GSM-R
- Control/ signalling system: Swiss Class B System SIGNUM until Domodossola I and II. SCMT on Italian side.
- Lingua franca: Italian
- Operational management: by RFI, dispatching of trains from and to Switzerland by BLS
- Infrastructure Brig – Iselle (border) property of SBB

- Infrastructre Iselle (border) – Domodossola property of RFI

Change of the line properties with regard to an ETCS-Equipment until 2015

- The following equipment will be implemented:
- ETCS L1 LS (CH) lines, stations or station sections
 - Line no. 145 from Iselle to Domo I (from km 19.06 to km 0.0 or mid of the station)
 - Line no. 145 from Domo I to Domo II (from km 5.06 to km 0.0 or mid of the station)

| Station | Necessary supervision (P44 EuroSIGNUM/EuroZUB, ETCS L1 LS) | Needed telegrams |
|---------------------|--|--|
| Iselle di Trasquera | Warning/Halt & Speed supervision | P44 (EuroSIGNUM/EuroZUB) ETCS L1 LS |
| Iselle - Varzo | Warning/Halt & Speed supervision | P44 (EuroSIGNUM/EuroZUB) ETCS L1 LS |
| Varzo | Warning/Halt & Speed supervision | P44 (EuroSIGNUM/EuroZUB) ETCS L1 LS |
| Varzo-Preglia | Warning/Halt & Speed supervision | P44 (EuroSIGNUM/EuroZUB) ETCS L1 LS |
| Preglia | Warning/Halt & Speed supervision | P44 (EuroSIGNUM/EuroZUB) ETCS L1 LS |
| Domodossola I | Warning/Halt & Speed supervision | P44 (EuroSIGNUM/EuroZUB) ETCS L1 LS |
| Domodossola II | Warning/Halt & Speed supervision | P44 (EuroSIGNUM/EuroZUB) ETCS L1 LS |

Table 7: Border section Brig – Domo equipment with other compatible signalling systems

- Deployment of ETCS on Italian part of the border-crossing line by RFI
- The line Iselle - Domodossola is owned and operated by RFI.
- Since the system is situated on the Italian territory, the Italian safety agency ANSF has the supervisory authority at this line.
- The interlockings are built by Italian suppliers. The signals are real Swiss signals which are connected to the Italian interlockings.
- The Swiss operating rules are valid for trains running on this line.
- Today all Swiss signals which are implemented at the Iselle - Domodossola line are equipped with the Swiss Class B Train Control System (TCS) SIGNUM.

Requirements

- The line Iselle – Domodossola is part of the European Corridor A/1. For this reason this line has to be equipped with ETCS technology by the end of 2015.
- In Switzerland the corridor lines will be equipped with ETCS L1 LS at the end of 2015, the whole network by end of 2017; some sections will be equipped with Level 2. As the line Iselle - Domodossola is operated under Swiss rules deployment of ETCS L1 LS⁸ is expected.

⁸ Discussions between the NSAs of CH and IT are ongoing what may have an impact on the installation.

- Locomotives which nowadays are traveling from Switzerland to Domodossola are equipped with SIGNUM/ZUB and ETM⁹. Many of them are additionally equipped with an ETCS on board unit according to SRS Baseline 2.
- Also in future these vehicles shall be able to travel from and to Domodossola with SIGNUM/ZUB functionality because of the lack of an ETCS on board unit according to the SRS Baseline 3. This means that this line also must be additionally equipped with P44 EuroSIGNUM/EuroZUB (Packet 44 with NID_XUSER=2 in Eurobalises).
- Trains traveling from Switzerland to Italy and vice versa have to transit to the correct ETCS Level (Mode) and must receive the correct National Values. A transition concept is needed which guarantees that all systems will be at the correct state after a transition.
- The valid engineering rules for ETCS L1 LS in Switzerland do only utilize linking in special cases. It might be that ANSF prescribe linking information for safety reasons in all balise groups.

Actual and future situation

The lines Iselle - Domodossola and Ranzo - Luino are situated on Italian territory. These lines are operated by RFI. The signalling system and operations are following the Swiss signal rule book and Swiss operations rules. Nowadays trains on these lines are supervised by the Swiss class B train control system SIGNUM which offers only Warning/Halt functionalities. This system will be replaced by standard ETCS technology by inserting the SIGNUM and ZUB functionalities into the ETCS Packet 44 (NID_XUSER=2). Parallel to these so called EuroZUB/EuroSIGNUM functionalities, ETCS L1 LS (BL 3) will be implemented by the end of 2015.

b) Ranzo (CH) – Luino (IT)

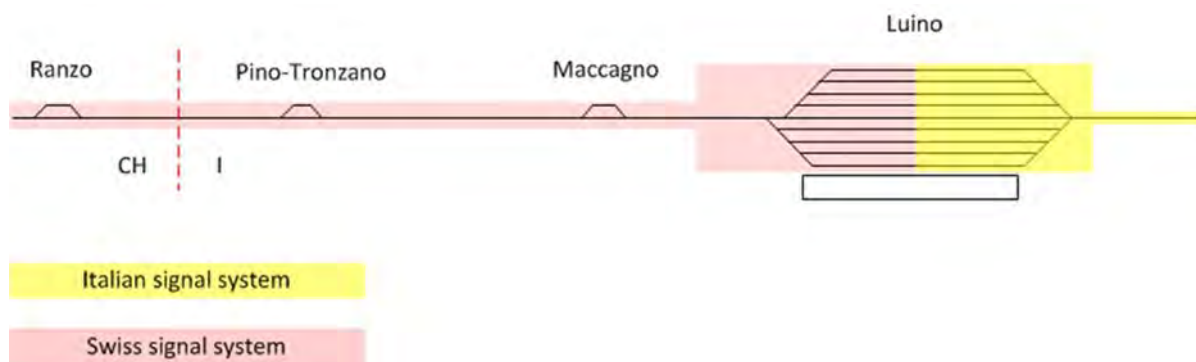

Figure 78: Installation of signalling systems on Ranzo – Luino line

| Line name/ -number | station / part of station part / border point | | km | |
|-----------------------|---|--------------|--------|-------|
| | from (country) | to (country) | from | to |
| 631 | Cadenazzo (CH) | Luino (IT) | 159.48 | 50.73 |

Currently important line properties

- Electrification: 15 kV alternating current until Luino, 3 kV DC on Italian side
- Change of electric power supply (catenary): static transition with powerless section at Luino.
- Operational handover station: Luino, operated by RFI staff

⁹ The trainborne ETM equipment converts and sends Packet 44 EuroSIGNUM/EuroZUB balise information to the trainborne SIGNUM/ZUB equipment.

- Communication system: GSM-R until Luino
- Control /signalling system: Swiss Class B System SIGNUM until Luino. SCMT an Italian side.
- Lingua franca: Italian
- Operational management:
 - Signaller: RFI staff in Pino, Maccagno and Luino
 - Dispatcher: SBB staff in Bellinzona
- Infrastructure Bellinzona – Ranzo (border) property of SBB
- Infrastruchtre Ranzo (border) – Luino property of RFI

Change of the line properties with regard to an ETCS-Equipment

The following equipment will be implemented. Lines or stations equipped with ETCS L1 LS (CH)

| Station | Necessary supervision (P44 EuroSIGNUM/EuroZUB, ETCS L1 LS) | Needed telegram packets | Comments |
|---------------|--|--------------------------------------|--|
| Pino-Tronzano | Warning/Halt & Speed supervision | P44 (EuroSIGNUM/EuroZUB), ETCS L1 LS | This balise group needs to be connected to the LEU on signal B. Wether this balise group is needed, will be decided in the project planning. |
| Luino | Warning/Halt & Speed supervision | P44 (EuroSIGNUM/EuroZUB), ETCS L1 LS | This balise group needs to be connected to the LEU on signal B. Wether this balise group is needed, will be decided in the project planning. |

Table 8: Stations equipped with Eurobalisses on Ranzo – Luino line (ERTMS sections with reference to TSI CCS)

Actual and future situation

The lines Iselle - Domodossola and Ranzo - Luino are situated on Italian territory. These lines are operated by RFI. The signalling system and operations are run following the Swiss signal rule book and Swiss operations rules. Nowadays trains on these lines are supervised by the Swiss class B train control system SIGNUM which offers only Warning/Halt functionalities. This system will be replaced by standard ETCS technology by inserting the SIGNUM and ZUB functionalities into the ETCS Packet 44 (NID_XUSER=2). Parallel to these so called EuroZUB/EuroSIGNUM functionalities, ETCS L1 LS (BL 3) will be implemented by the end of 2015.

General Project Risks

Authorization Process

As described above, the lines Ranzo - Luino and Iselle - Domodossola have to be equipped with ETCS technology where P44 (EuroSIGNUM/EuroZUB) and ETCS L1 LS will be the protection systems. In addition to these systems, Chiasso station shall also be protected by the Italian train protection system SCMT.

Therefore RFI and FFS declare that the only way to obtain an authorization for ETCS and P44 EuroSIGNUM/EuroZUB for these lines and stations is by signing a contract of “cross acceptance” between ANSF and FOT. A legal basis is required for the cross acceptance.

Within this contract ANSF and FOT must define the approval process and the responsibility for train control systems on the border transitions between Italy and Switzerland.

This approval process for all borders must base on the principle of cross acceptance. Meetings between RFI, SBB, ANSF and FOT are ongoing.

7.1.5.5.3.4 Investments

By the Decision EC 2007-IT-60360-P Italy is beneficiary of 33 Million € for a Project to install ERTMS on the Corridor A for a total co-financed amount of 66 Million €.

7.1.6 ERTMS Implementation with Reference to Regulation (EU) No 913/2010

7.1.6.1 The Netherlands

7.1.6.1.1 Description of Corridor Lines

There are no additional agreements/demands for the Netherlands regarding Corridor A under this regulation.

7.1.6.1.2 Migration Goals and Strategy for the Network

At this time there is no approved general migration strategy in the Netherlands. The Dutch ministry is working on the strategy. More information is found in Railmap ERTMS (European Rail Traffic Management System) version 1.0 on the website of the ministry:

<http://www.rijksoverheid.nl/documenten-en-publicaties/kamerstukken/2013/02/13/railmap-ertms-european-rail-traffic-management-system-versie-1-0.html>

By the end of 2013 the Dutch ministry, in collaboration with the Dutch rail sector, will publish Railmap Version 2.0. It will describe feasible scenarios for a phased and manageable deployment of ERTMS in the Netherlands. A political decision is to be expected in the first half of 2014.

7.1.6.2 Belgium

7.1.6.2.1 Description of Corridor Lines

The corridor lines (principal and diversionary lines) of the Belgian part of RFC 1 are presented in the table below.

| Principal/Diversiory Route | line no. | from (name of location) | to (name of location) |
|----------------------------|----------|------------------------------|------------------------------|
| Principal line | L51A | Zeebrugge Vorming | Y Dudzele |
| Principal line | L51 | Y Dudzele | Brugge |
| Principal line | L50A | Brugge | Gent St. Pieters |
| Principal line | L50 | Gent St. Pieters | Y .West Driehoek Ledeborg |
| Principal line | L50 | Y .West Driehoek Ledeborg | Y.Oost Driehoek Ledeborg |
| Principal line | L50 | Y.Oost Driehoek Ledeborg | Y Melle |
| Principal line | L50 | Y Melle | Schellebelle |
| Principal line | L53 | Schellebelle | Dendermonde |
| Principal line | L53 | Dendermonde | Mechelen |
| Principal line | L53 | Mechelen | Y Muizen |
| Principal line | L53 | Y Muizen | Muizen Rooster T |
| Principal line | L53 | Muizen Rooster T | Y Dyleburg |
| Principal line | L53/1 | Y Dylebrug | Y.Holsbeek |
| Principal line | L35 | Y.Holsbeek | Y. Zuid Driehoek Aarschot |
| Principal line | L35 | Y. Zuid Driehoek Aarschot | Y. Oost Driehoek Aarschot |
| Principal line | L35 | Y. Oost Driehoek Aarschot | Hasselt |
| | | | |
| Principal line | L10 | Antwerpen-Kallo | Y Kattestraat |
| Principal line | L10/2 | Y Kattestraat | Y Zwindrecht-Fort |
| Principal line | L59 | Y Zwindrecht-Fort | Antwerpen-Berchem |
| | | | |
| Principal line | L27 | Mechelen | Y Duffel |
| Principal line | L13/1 | Y Duffel | Y Lint |
| Principal line | L13 | Y Lint | Lier |
| | | | |
| Diversiory line | L58/1 | Y West Driehoek Ledeborg | Y Noord Driehoek Ledeborg |
| Diversiory line | L58 | Y Noord Ledeborg | Gent Dampoort |
| Diversiory line | L58 | Gent Dampoort | Gent-Zeehaven |
| Diversiory line | L59B | Gent-Zeehaven | Y Bernadettestraat |
| Diversiory line | L59 | Y Bernadettestraat | Y.Melsele |
| Diversiory line | L59 | Y.Melsele | Y.Zwijndrecht-Fort |
| | | | |
| Principal line | L27A | Antwerpen Noord Inrit C1 | Antwerpen Schijnpoort |
| Principal line | L27A | Antwerpen Schijnpoort | Antwerpen-Berchem |
| Principal line | L27A | Antwerpen-Berchem | Y.Krijgsbaan |
| Principal line | L15/1 | Y.Krijgsbaan | Y Aubry |
| Principal line | L15 | Y Aubry | Lier |
| Principal line | L15 | Lier | Y Nazareth |
| Principal line | L16 | Y Nazareth | Nieuwe Y. Noord Dr. Aarschot |
| Principal line | L35 | Nieuwe Y. Noord Dr. Aarschot | Y. Oost Driehoek Aarschot |
| Principal line | L35 | Y. Oost Driehoek Aarschot | Hasselt |
| | | | |
| Principal line | L34 | Hasselt | Bilzen |
| Principal line | L34 | Bilzen | Y Glons |
| Principal line | L24 | Y Glons | Y Berneau |
| Principal line | L24 | Y Berneau | Montzen - Block 15 |
| Principal line | L24 | Montzen - Block 15 | Montzen border (Botzelaer) |

Table 9: Corridor lines to be equipped with ERTMS in Belgium

The connecting lines (A and B) to freight areas or terminals are presented in Figure 85: ETCS levels on RFC 1 in Belgium.

7.1.6.2.2 Migration Goals and Strategy for the Network

Current situation

The current situation (25/02/2013) is as follows:

- Most lines of the conventional network are equipped with a simple warning system (Crocodile); that system is required on board.
- A few conventional lines are additionally equipped with a simple ATP system (TBL1); that system is not supported anymore by the supplier and is end of life.
- The conventional lines are also equipped with a simple ATP system (TBL1+) based on ETCS components. The TBL1+ system is an improved version of TBL1, including a simple speed control in front of a number of main signals at stop aspect. The roll out is still on-going, although all critical locations are already equipped.
- 2 HS lines are equipped with national systems (L.1 to the French border with TVM430 and L.2 Leuven – Liège with TBL2).
- The most recent HS lines are equipped with ETCS Level 2 + ETCS Level 1 (L.3 Liège – German border and L.4 Antwerp – Dutch border). The version is 2.2.2 with the CR contained in the subset 108 1.0.
- Already 2 parts of the Corridor C/2 are equipped with ETCS Level 1 (v.2.3.0d): Mechelen (excl.) - Leuven (excl.) [also part of RFC 1] and Virton - Athus.

Future situation

In 2011 Infrabel developed a Master plan for ETCS implementation on the whole conventional network.

The principles are the following:

- The main goals are: a higher safety level and an optimal level of interoperability.
- The current implementation of TBL1+, considered as a first step towards ETCS, will be completed in 2015 and this will improve the train protection significantly.
- ETCS will be installed first on the new or upgraded lines and on the Corridor C/2 lines as required in the ERTMS European Deployment Plan.
- The remaining lines of the conventional network will be equipped until 2022.
- The complete picture will be a mix of Level 1 FS, Level 2 FS and Level 1 LS.
- Limited Supervision (LS) will be installed on lines with lower traffic density.

Migration

The migration steps are the following:

- Completion of the TBL1+ implementation (99,9 % of the risk to be covered) by the end of 2015.
- New or upgraded lines or line sections shall be equipped with ETCS when they are put into service. The standard is: version 2.3.0d, Level 1. Are concerned:
 - The L.36 – L.36N between Schaarbeek (excl.) and Leuven (excl.), with an upgrade of L.36N to 200 km/h (01/2012);
 - The “Diabolo” line, new passenger line between Brussels Airport station and Mechelen (06/2012)
 - The “Liefkenshoektunnel”, new freight line between the left bank and the right bank of the port of Antwerp (2014)
- Existing ETCS on the HS lines will be upgraded to 2.3.0d (likely in 2014).
- Corridor C/2 lines are being equipped with ETCS (2.3.0d, Level 1). All Corridor C/2 lines will be fitted with ETCS by 12/2015 except some alternative routes.

- ETCS will be installed on the whole conventional network (except some harbour lines and industrial lines) by 2022. It will be a mix of Level 1 FS, Level 2 FS and Level 1 LS. The choice is the result of a risk analysis.
- As from 2025 all rolling stock will be required to be equipped with ETCS, to be allowed to run on the conventional network.

Cost Benefit analysis

Implementation of ETCS on the Belgian part of the RFC 1 brings obvious interoperability benefits for the RU's as there will be no need to maintain the existing ATP systems. Also the safety level will be further improved.

This project can be regarded as part of the Infrabel ETCS Master plan: this plan covers the whole conventional network and is not limited to freight corridors; the investments needed to equip the RFC 1 lines with ETCS are no specific RFC 1 investments but only a part of a whole project.

Technical standards, baselines, levels – Principles

Infrabel has defined the general principles applicable to the whole conventional network, both in Level 1 FS and Level 2 FS. A similar work regarding Level 1 LS is on-going.

As ETCS will coexist with the line side signalling for a number of years, the main concerns are:

- To ensure the full consistency with the signalling principles in force;
- To ensure the coexistence of ETCS and TBL1+.

Technical standards, baselines, levels – Baselines

Baseline 2 (version 2.3.0d) will be implemented for Level 1 and Level 2 at least until 2016. Early implementation of the braking curve functionality (M_VERSION = 1.1) is planned as from 2016. This will allow trains equipped with ETCS Baseline 3 to make optimal use of the braking curve functionality (with the Belgian national values) while the operation of trains equipped with ETCS 2.3.0d (without that functionality) will remain unchanged.

Baseline 3 will be used for ETCS Level 1 LS. Infrabel has not yet decided by when Baseline 3 will be the standard for the Level 1 FS and Level 2 FS implementation.

Technical standards, baselines, levels – Levels

ETCS Level 1 will make no use of Euroloop or radio infill.

Possible issues are expected with the capacity of the GSM-R network for the Level 2 application. An upgrade of the GSM-R network will be necessary. In several locations (i.e. Gent), this might include micro cells or even (in the worst case) GPRS. Also the interference issues will have to be solved, for which EC initiatives are expected, to cope with those issues.

Technical standards, baselines, levels – Contracts

Two contracts for TBL1+ and ETCS Level 1 are on-going.

Implementation of ETCS Level 1 LS is planned to be part of the on-going contracts.

Another contract for ETCS Level 2 (together with new interlockings) is currently in negotiation phase. The contract is expected to be awarded in 2013.

The implementation of ETCS Level 2 will require an upgrade of GSM-R on the lines concerned. A tender is in preparation.

7.1.6.2.3 Impact on ETCS Equipment of Vehicles

Current Class B systems

The current Class B systems in use on the conventional network are the following:

- The “Crocodile” system is a warning system; availability of that system on board is a track access condition for the conventional network, as decided by the Ministry of Transport.
- The TBL1 system is a Warning-Stop system installed on a small part of the network. The crocodile functionality is included in the TBL1 on-board equipment. Availability of that system on board is no track access condition; only a limited part of the fleet of SNCB (historic railway operator in Belgium) is equipped. That system is end of life; it is expected that a number of TBL1 balises will be removed in the near future.
- TBL1+ is NOT a Class B system and availability of that system on board is no track access condition. The crocodile functionality is included in the TBL1+ on-board equipment.

Technical requirements for vehicles: current situation

The technical requirements in force are defined in the Ministerial Decree of 30/07/2010: “*Arrêté Ministériel portant adoption des exigences applicables au matériel roulant pour l’utilisation des sillons*”.

Only the Crocodile system (or another system, providing at least the same functionality, e.g. TBL1+ or ETCS + STM (TBL1)) is required on board on the conventional network.

Specific requirements are set about ETCS:

- The OBU shall be designed in such a way that the selection of a wrong mode or level during the Start of Mission is prevented or corrected. The CR513 regarding the mode NL is applicable.
- The OBU shall be designed in such a way that the transitions are performed correctly in case of a failure of either the announcement balises or the execution balises.
- The braking performance calculated on board shall not exceed the actual braking performance of the train.
- In vehicles equipped with an EVC, all cab information (related to the CCS system, including the actual train speed) shall be displayed on the ETCS DMI.
- The ETCS trackside parameters are published in the infrastructure register.

The infrastructure register of each line equipped with ETCS gives information regarding:

- The maximum IND distances;
- The number of GSM-R data connexions required;
- The need for a KMAC key to be delivered by a KMS system.

Technical requirements for vehicles: possible evolution as from 2015

In the Ministerial Decree of 30/07/2010 a clause gives Infrabel the possibility to impose justified restrictions as from 01/01/2015 on trains, not equipped with TBL1+ nor ETCS, to run on lines equipped with both ETCS and TBL1+ (unless the train and the line are equipped with TBL1). For the time being, no such restrictions have been decided yet.

Legislation to fade out the legacy system in favour of ETCS has come into force by Royal Decree on 9 July 2013. From 1 January 2016 onwards, the class B system Memor-crocodile will be put out of service on those lines equipped with ETCS Level 1 version 2.3.0.d (the balises will also continue to transmit the packet 44 TBL+ information; ETCS (or TBL+) on-board systems will be mandatory to run on those lines.

Technical requirements for vehicles: possible evolution as from 2025

Another adaptation of the above mentioned Royal Decree by 2025 is very likely to enforce ETCS as a track access condition (and removing the Memor-crocodile system) on all rolling stock in Belgium.

7.1.6.2.4 Requirements for Roll Out, Testing and Authorisation

Corridor Roll out plan

The planning is described in the figure below.

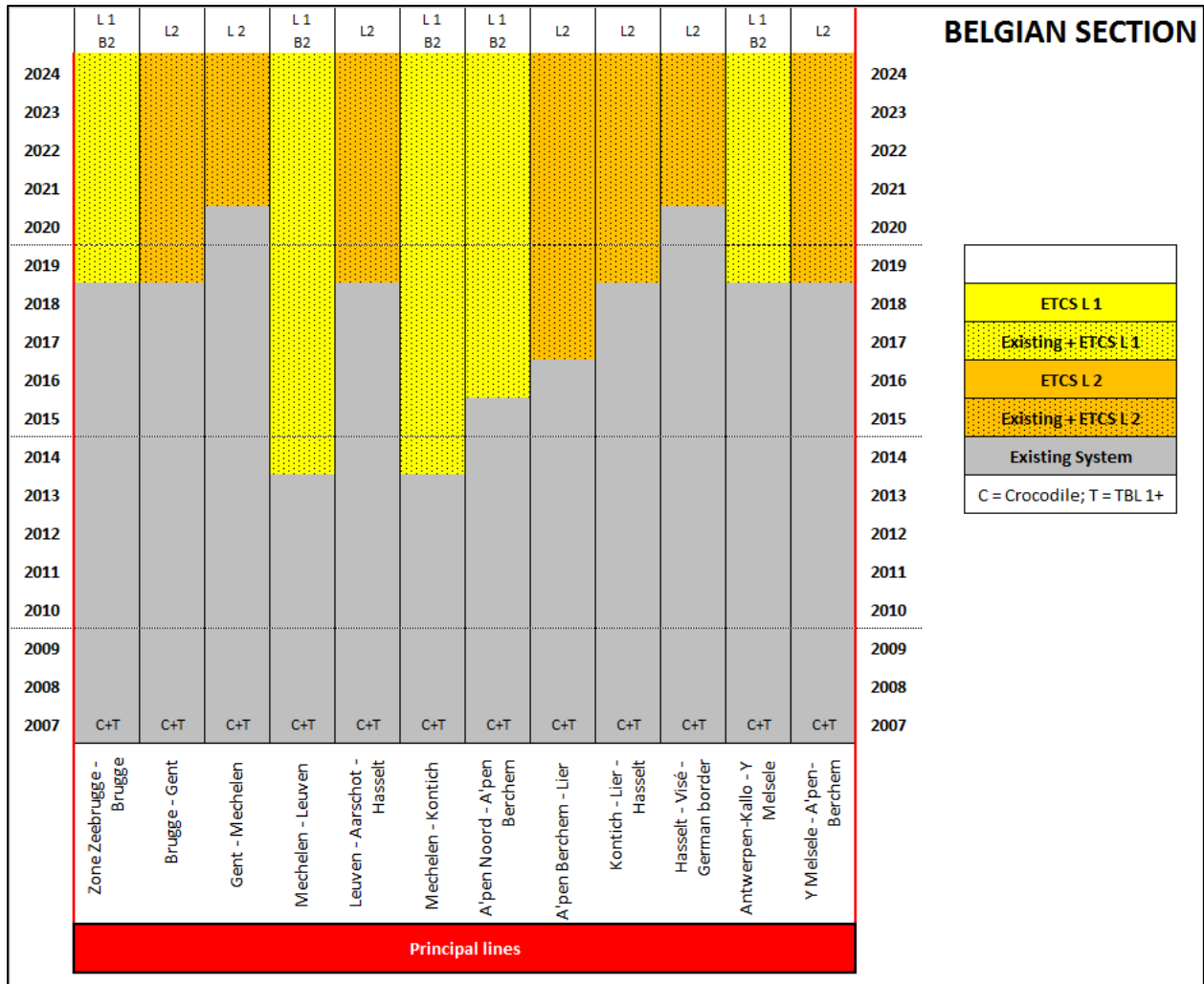

Figure 79: ETCS roll out plan in Belgium

Testing and authorisation

A development phase of the ETCS Level 2 project is planned in 2013-2014, before the roll out on RFC 1 can start. A pilot line (outside RFC 1) will be equipped and tested in 2014-2015.

The ETCS (Level 2) principles applied on the pilot line will be applicable to all conventional lines to be equipped with ETCS L2, including RFC 1. So we expect that possible technical issues regarding ETCS L2 on the conventional network will be solved before the roll out will start on RFC 1.

A similar process is planned for the Limited Supervision; however the exact timeline is not yet defined.

To test the trackside implementation, Infrabel uses a test train, able to simulate a number of different passenger and freight trains.

In the current situation, the authorisation for placing into service of ETCS on board units is based on a number of tests, decided by the NoBo. An existing EC certificate, based on tests performed on another line (possibly in another country) sometimes contains restrictions because not all ETCS functionalities could be tested on that line. So additional tests may have to be performed in order to be allowed to run on Infrabel lines equipped with ETCS. It is expected that in future, most tests will be performed in accredited laboratories, in such a way that the EC certificates will not contain restrictions anymore. This will facilitate the authorisation process.

7.1.6.2.5 ETCS Investments

The estimated investments required are as in the table below. All ETCS investments are considered, including those related to line sections in common with Corridor C/2 and the investments already made. Renewal of interlocking's, necessary for ETCS L2 is not included; indeed, those interlockings generally end of life.

| Project | Amount (Mio EUR) |
|---------------------------|------------------|
| ETCS L2 | 161 |
| GSM-R upgrade for ETCS L2 | 9 |
| ETCS L1 | 39 |
| ETCS1 L1 LS | 9 |
| Total | 219 |

Table 10: Estimated ETCS investments on RFC 1 (all types of lines)

The multi-annual investment plan 2013-2025 foresees the financing of the ETCS project.

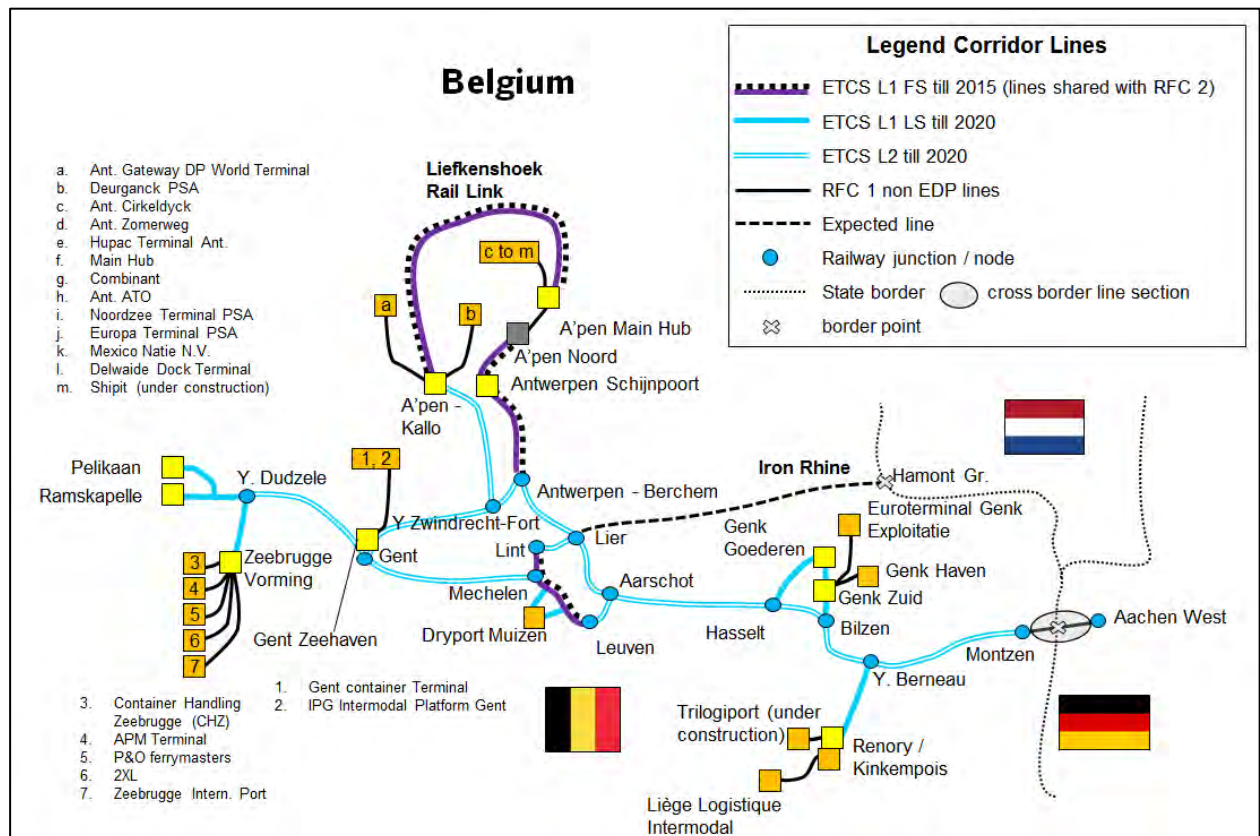

Figure 80: ETCS levels on RFC 1 in Belgium

7.1.6.3 Germany

7.1.6.3.1 Description of Corridor Lines

The obligatory equipment of Corridor A is a subset of the planned and indicative equipment for Rail Freight Corridor 1. The following rail freight areas in reference to TSI ZZS will be included: Duisburg, Köln, Mannheim/Ludwigshafen.

As foreseen in the upcoming Regulation concerning the TEN-T guidelines, there is a need for solutions for the ERTMS deployment on the whole rail freight corridor, and in particular on the remaining non-interoperable sections such as the line connecting corridor A with the Belgian-German border.

A strategy regarding the other RFCs (apart from RFC 1) has not yet been defined, as financing has nationally not yet been agreed on.

7.1.6.3.2 Migration Goals and Strategy for the Network

ETCS will be part of the deployment of new built lines and by larger reinvestments within the TEN Network. Germany decided to fit their lines with ETCS L2 and L1.

Today, GSM-R is in several EU Member States subject to interference mainly coming from public mobile operators in these countries. It is agreed with the EC that GSM-R has a supporting character and, if blocked or disturbed from public mobile networks, it may increase safety risks and reduce the wanted ETCS capacity improvements due to additional operational rules. EC is aware on the increasing problem, especially in the light of 2009/766/EC which gives the framework for terrestrial systems capable of providing pan-European electronic communications services in the Community. A deployment of LTE and UMTS technologies in the 900 MHz band is expected, which will increase the interference problems (DG CONNECT on 15.2.13: “In the short to medium term, LTE will have to co-exist with existing technologies”).

DB is expecting a binding regulation after finalisation of the currently working DG-MOVE experts group and the on-going consultations on CEPT level.

7.1.6.3.3 Impact on ETCS Equipment of Vehicles

See 7.1.5.3.2.3 National Technical Requirements for Vehicles

National technical requirements for the SRS 3.3.0

Note: The list of our national technical rules is preliminary. In the framework of the assessment of our requirements specification (Neue Typzulassung), it might become necessary for us to address additional national technical rules to the train operators.

7.1.6.3.4 Requirements for Roll Out, Testing and Authorisation

A strategy regarding the RFCs has not yet been defined, as implementation will presumably take place in a period in which test and commissioning planning anyway has to be revised.

7.1.6.3.5 ETCS Investments

A preliminary plan will be developed after conclusion of the pending planning agreement between Germany and the Infrastructure Manager DB Netze. As no further strategy beyond Corridor A and the other German ERTMS projects is defined, there is for the time being no investment plan.

7.1.6.4 Switzerland

7.1.6.4.1 Description of Corridor Lines

In context with the North-South axes through Switzerland (Lötschberg - Simplon resp. Gotthard - Ceneri/Luino) it was agreed with the Corridor A and C countries to implement ETCS. On the North-South axes, ETCS must come into operation with timetable change in December 2015.

On the remaining standard-gauge network, ETCS must come into operation at the changeover to the new timetable in December 2017. How this will be implemented, is explained in chapter 5.6 of this implementation plan (see above).

7.1.6.4.2 Migration Goals and Strategy for the Network

In January 2000, the Federal Office of Transport (FOT) issued a strategy for the railway undertakings covering the migration to ETCS.

The strategy includes the following important principles:

- The transition to cab signalling (ETCS Level 2) for routes with speeds above 160 km/h will take place as part of the planned new construction projects.
- On existing interoperable routes, potential danger points have been gradually equipped with Eurobalises and Euroloop since 2003, using a risk-based approach. The assessment of the danger points and the related risks is carried out by all the railway undertakings using the same criteria and is based on existing risk analyses completed by the SBB and by the FOT or the private rail companies.

The main objectives of the FOT's strategy for the migration to ETCS are as follows:

- By replacing the existing national train protection systems ZUB and SIGNUM with ETCS L1 LS in the infrastructure rapidly and throughout the network, it will be possible to ensure that very quickly only one type of train protection equipment will be needed in the trains. When only the ETCS equipment is required, the costs of procurement and maintenance for the trains will be significantly reduced.
- The longer-term objective is to introduce ETCS Level 2, which requires the replacement of the relay interlocking system. The use of ETCS Level 1 LS on existing lines with conventional, visual signalling systems will help to avoid the relay interlocking system being replaced early, which would not be cost-effective.
- Making targeted use of risk-based speed control systems will enable risks to be reduced quickly and efficiently.

In order to ensure that the migration process remains manageable in technical, operational and financial terms, additional measures have been taken:

- Trains with SIGNUM/ZUB equipment have also been fitted with the Eurobalise transmission module (ETM) since the start of 2003 (Figure 86, left side). The ETM can read SIGNUM and ZUB information from the Eurobalises/Euroloop in the EuroSIGNUM and EuroZUB P44 technical language, using ETCS packet 44 (Figure 86, right side).

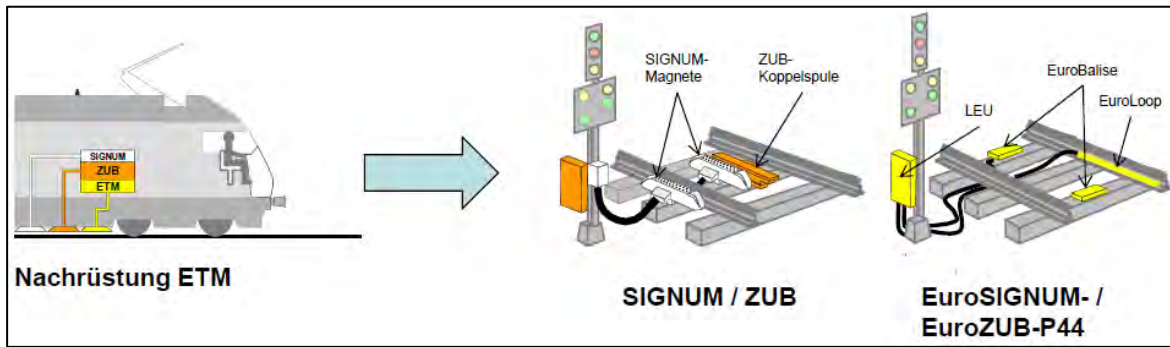

Figure 81: Upgrading with ETM

The migration to ETCS consists of replacing the trackside elements SIGNUM and ZUB by ETCS elements (balises) with SIGNUM and ZUB functionality via packet 44 telegrams. The balises will also transmit ETCS Level 1 LS information.

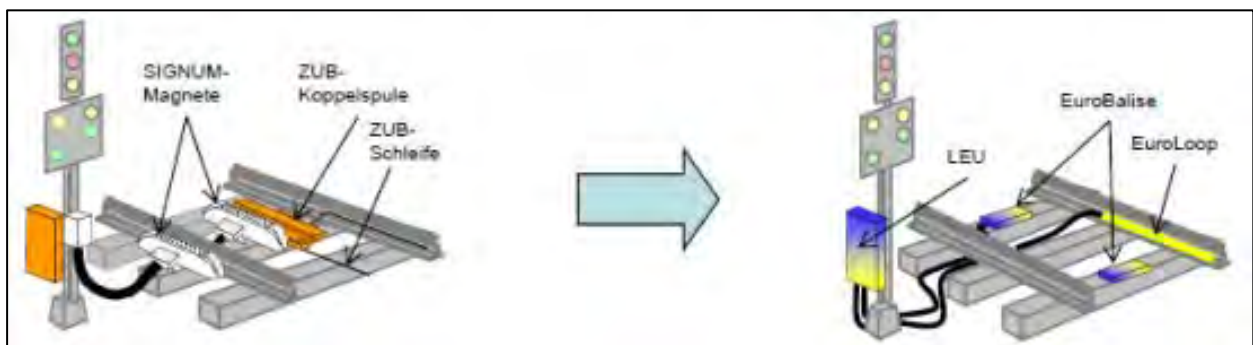

Figure 82: Comparison Signum/Zub and ETCS

This allows, without restrictions, the operation for vehicles equipped with:

- SIGNUM, ZUB, ETM and ETCS Baseline 2.x.x
- SIGNUM, ZUB262ct and ETCS Baseline 2.x.x
- ETCS Baseline 3.x.x

This measure gives the possibility for ETCS-only vehicles (Baseline 3), as well as for vehicles still equipped with SIGNUM- and ZUB-Systems, to run on sections with optical signalling.

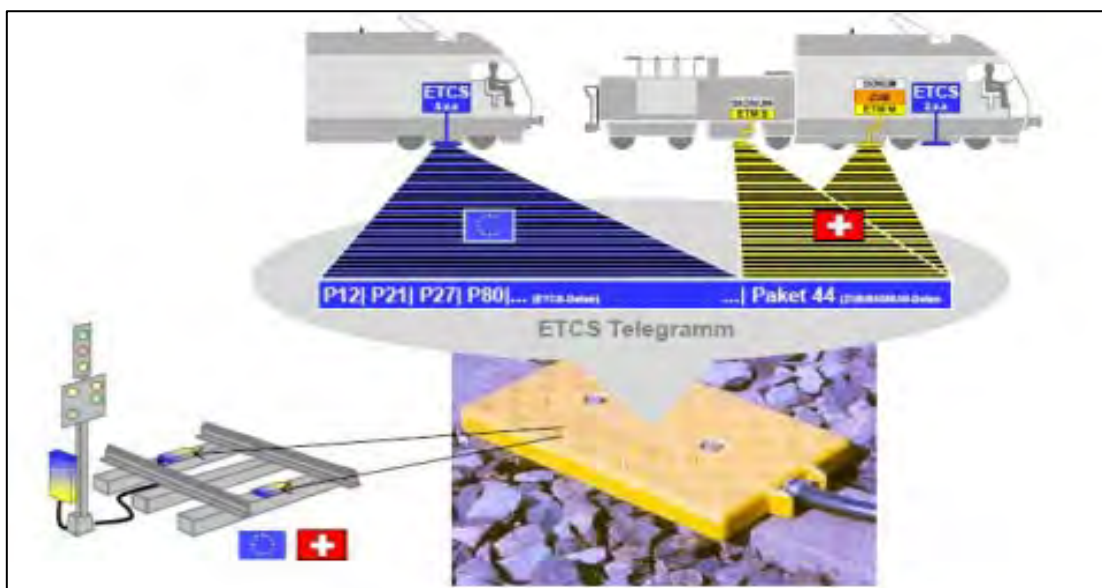

Figure 83: Vehicle operation

1st objective is the migration of the North-South axes Switzerland.

On the North-South axes in Switzerland, ETCS must come into operation at the changeover to the new timetable in December 2015.

On the remaining standard-gauge network, ETCS must come into operation at the changeover to the new timetable in December 2017.

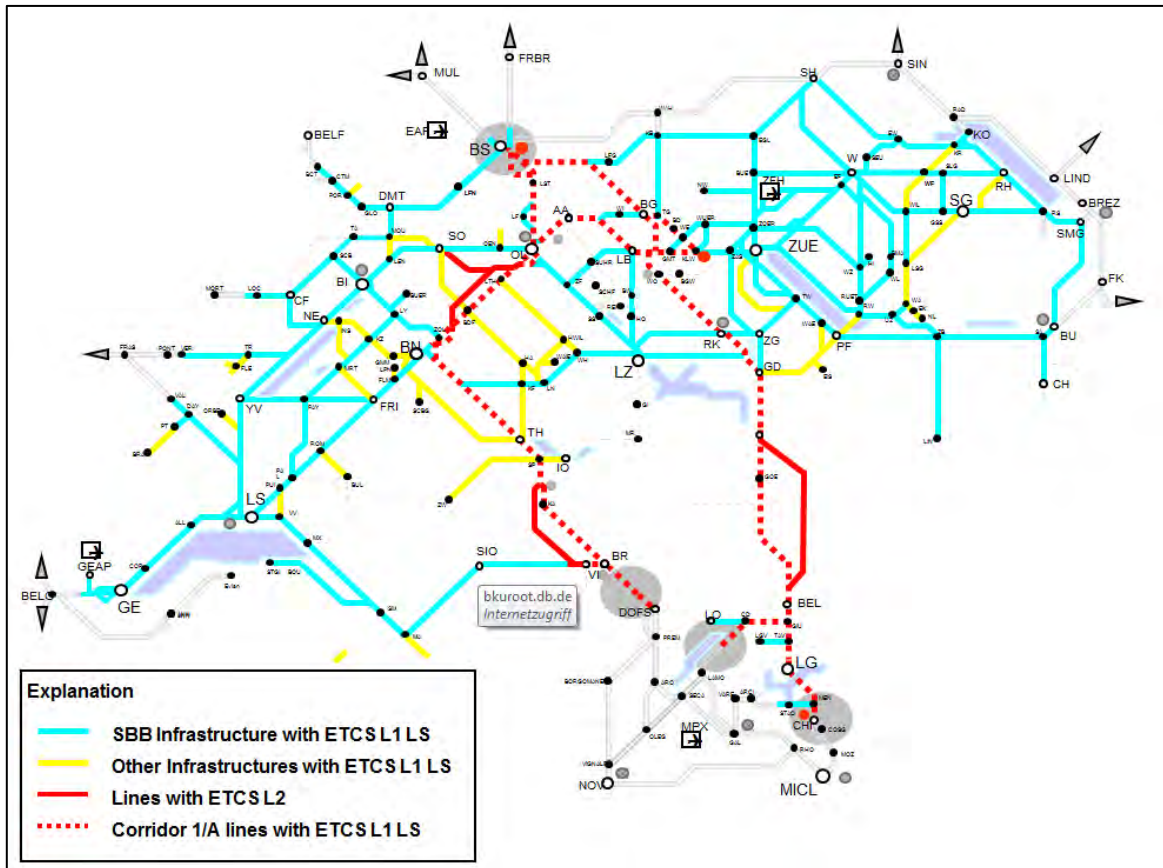

Figure 84: ETCS Level 1 and Level 2 in Switzerland

Phase 2 of ETCS Rollout

In 2025 Swiss-wide rollout of ETCS Level 2 in connection with replacements of interlockings will start. Extensions of ETCS Level 2 areas in this context will be implemented if economically reasonable. This will, of course, also include sections on the Corridor A/1 routes.

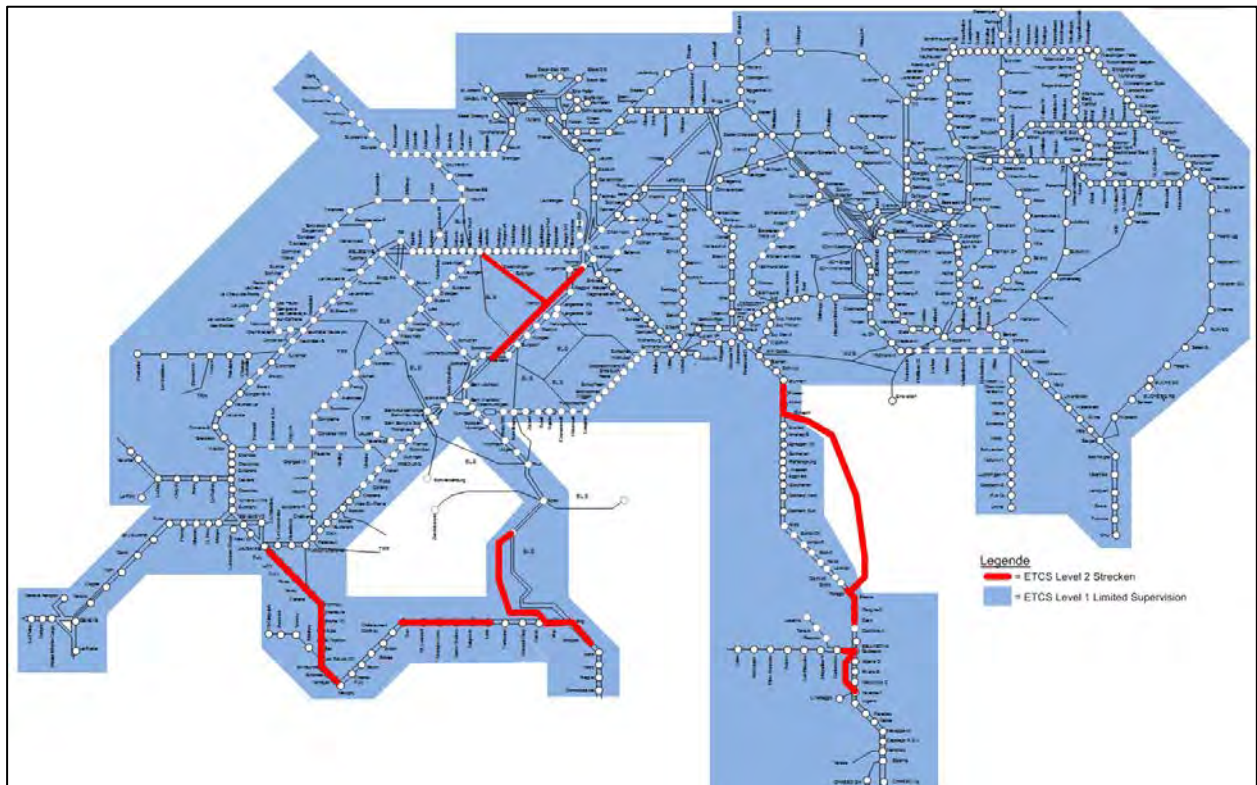

Figure 85: Extension of ETCS Level 2 in Switzerland

7.1.6.4.3 Impact on ETCS Equipment of Vehicles

See section 7.1.5.4.2.3 National Technical Requirements for Vehicles

7.1.6.4.4 Requirements for Roll Out, Testing and Authorisation

See section 7.1.5.4.2.5 Testing and Authorisation

7.1.6.4.5 ETCS Investments

The investment costs (in CHF) for ETCS (trackside only) for ETCS implementation until 2017 on the remaining Swiss network amounts to about 845 Mio. GSM-R is not included.

For detailed information see the annual ETCS-Report of FoT.

Link: <http://www.bav.admin.ch/dokumentation/publikationen/00568/00570/01501/index.html?lang=de>

7.1.6.5 Italy

7.1.6.5.1 Description of Corridor Lines

The routes for the freight RFC 1 will be the same as in the EDP with the exception of the Milan bypass (Seregno-Cremona-Voghera) that is not included. ETCS is also foreseen on RFC 1 on the lines connecting Piacenza to Milan and Voghera. The section Piacenza – Milano is planned within 2020, the section Piacenza – Voghera within 2015.

7.1.6.5.2 Migration Goals and Strategy for the Network

See chapter 7.1.5.5.3.1

7.1.6.5.3 Impact on ETCS Equipment of Vehicles

No strategy available at the moment

7.1.6.5.4 Requirements for Roll Out, Testing and Authorisation

Guidelines by the national safety authority expected by the third quarter of the year

7.1.6.5.5 ETCS Investments

See chapter 7.1.5.5.3.4

Reference to Union Contribution

Based on the information published on the Trans-European Transport Network Executive Agency website we have made the following table which reflects all projects related to the Corridor A/1 Rotterdam – Genoa.

| Project number | Project description |
|-----------------------------------|--|
| 2012-DE-94085-S | Support to the long term implementation of the TEN-T network in the development of Corridor A/1 Rotterdam – Genoa required by the Regulation (EU) No 913/2010 and conversion of governance structure to a European Rail Freight Corridor 1 |
| 2011-NL-93022-S | Freight corridor Betuweroute-southeast Netherlands-Germany (Corridor 1) |
| 2011-NL-60003-P | Prototyping, (interoperability) testing, rehomologation and the retrofit of Siemens ES64U2 locomotives with ETCS L1/L2 2.3.0.d for Corridor A, B and E networks in DE, AT, HU and CH |
| 2011-NL-60001-P | Implementation and testing of the interface between the German Baseline 3 system and the Dutch 230d ERTMS systems |
| 2011-IT-60002-P | Upgrading of ERTMS system on Trenitalia fleet to 2.3.0.d version |
| 2011-EU-60013-S | Facilitating and speeding up ERTMS deployment |
| 2011-EU-60009-S | Simulation Environment for Fast ERTMS Validation |
| 2011-EU-60008-S | Study and implementation of major parts of the Corridor Freight Regulation (EU) No 913/2010 |
| 2011-EU-60005-S | Preparatory studies for the implementation of additional measures on ERTMS Corridor Rotterdam-Genoa and ERTMS Corridor Antwerp-Basel-Lyon |
| 2010-NL-92227-S | Studies concerning the extension of railway yard Maasvlakte West- Phase 1 |
| 2010-NL-92226-S | Studies concerning the construction of the third Track Zevenaar-German border |
| 2010-FR-92204-P | Adaptation of the existing line between Mulhouse and the border for use by high-speed (TGV) or intercity express (ICE) trains on the Mulhouse-Mulheim (Freiburg) corridor |
| 2009-IT-91404-S | Upgrade of the Tortona-Voghera section, Priority Project 24, Final Design |
| 2009-DE-24070-E | Equipment with electronic interlocking of the railway line between Emmerich (Dutch-German border) and Basel (German-Swiss border), within Corridor A Rotterdam-Genoa |
| 2008-DE-91003-S | Studies for the removal of the level crossings on the section Oberhausen-Emmerich |
| 2007-NL-60310-P | ERTMS implementation the Railway Corridor Rotterdam-Genoa- Netherlands part - Section Port Railway of Rotterdam |
| 2007-IT-60360-P | Trackside ERTMS equipment on Italian part of Corridor A (600 km) |
| 2007-IT-24010-S | Railway node of Genoa - Study for upgrading the section Genoa Voltri-Genoa Brignole |
| 2007-IT-60030-P | Migration towards ERTMS/ETCS for Trenitalia on-board equipment |
| 2007-EU-60410-S | Programme Management Office for the ERTMS deployment on the Corridor Rotterdam-Genoa |
| 2007-EU-24090-S | "Iron Rhine" |
| 2007-DE-60320-P, ERTMS Corridor A | Equipment with ETCS of the railway section from Emmerich to Basel as part of the Corridor A Rotterdam - Genoa |
| 2007-DE-24060-P | Works for construction and re-construction of the partially existing railway section between Karlsruhe and Basel |
| 2007-DE-24040-P | Studies and works for the upgrading of the high speed railway line Duisburg-Emmerich |
| 2005-DE-90308-S | Planning for the upgrading of the railway connection line NL/D border – Emmerich-Oberhausen |

Table 11: Union contribution on Corridor A/1 Rotterdam - Genoa

Source Trans-European Transport Network Executive Agency (TEN-T EA)

Links http://tentea.ec.europa.eu/en/ten-t_projects/30_priority_projects/priority_project_24/priority_project_24.htm

http://tentea.ec.europa.eu/en/ten-t_projects/ten-t_projects_by_transport_mode/rail_includes_ertms.htm

Annex 1 List of Rail Freight Corridor Lines

| Line Type | IM | line no. | from (name of location) | to (name of location) |
|--------------|----------|----------|---------------------------|---------------------------|
| Principal | ProRail | | Maasvlakte West/Oost | Waalhaven Zuid |
| Principal | ProRail | | Waalhaven Zuid | Barendrecht |
| Principal | ProRail | | Barendrecht | Kijfhoek |
| Principal | Keyrail | | Kijfhoek | Meteren |
| Principal | Keyrail | | Meteren | Zevenaar Oost |
| Principal | Keyrail | | Zevenaar Oost | Zevenaar Grens |
| Connecting A | ProRail | | Vlissingen Sloehaven | Breda |
| Diversiary | ProRail | | Kijfhoek | Breda |
| Diversiary | ProRail | | Breda | Eindhoven |
| Diversiary | ProRail | | Eindhoven | Venlo |
| Diversiary | ProRail | | Venlo | Venlo Grens |
| Connecting A | ProRail | | Amsterdam CS | Beverwik |
| Principal | ProRail | | Amsterdam Westhaven | Amsterdam CS |
| Principal | ProRail | | Amsterdam CS | Utrecht C |
| Principal | ProRail | | Utrecht C | Meteren |
| Connecting A | Infrabel | L 202 B | Zebbrugge Ramskapelle | Y Pelikaan |
| Connecting A | Infrabel | L 202 B | Zebbrugge Pelikaan | Y Pelikaan |
| Connecting A | Infrabel | L 51 B | Y Pelikaan | Y Dudzele |
| Principal | Infrabel | L51A | Zeebrugge Vorming | Y Dudzele |
| Principal | Infrabel | L51 | Y Dudzele | Brugge |
| Principal | Infrabel | L50A | Brugge | Gent St. Pieters |
| Principal | Infrabel | L50 | Gent St. Pieters | Y .West Driehoek Ledeborg |
| Principal | Infrabel | L50 | Y .West Driehoek Ledeborg | Y.Oost Driehoek Ledeborg |
| Principal | Infrabel | L50 | Y.Oost Driehoek Ledeborg | Y Melle |
| Principal | Infrabel | L50 | Y Melle | Schellebelle |
| Principal | Infrabel | L53 | Schellebelle | Dendermonde |
| Principal | Infrabel | L53 | Dendermonde | Mechelen |
| Principal | Infrabel | L27B | Muizen Goederen | Muizen Rooster T |
| Principal | Infrabel | L53 | Mechelen | Y Muizen |
| Principal | Infrabel | L53 | Y Muizen | Muizen Rooster T |
| Principal | Infrabel | L53 | Muizen Rooster T | Y Dyleburg |
| Principal | Infrabel | L53/1 | Y Dylebrug | Y.Holsbeek |
| Principal | Infrabel | L35 | Y.Holsbeek | Y. Zuid Driehoek Aarschot |
| Principal | Infrabel | L35 | Y. Zuid Driehoek Aarschot | Y. Oost Driehoek Aarschot |
| Principal | Infrabel | L35 | Y. Oost Driehoek Aarschot | Hasselt |
| Principal | Infrabel | L10 | Antwerpen-Kallo | Y Kattestraat |
| Principal | Infrabel | L10/2 | Y Kattestraat | Y Zwindrecht-Fort |
| Principal | Infrabel | L59 | Y Zwindrecht-Fort | Antwerpen-Berchem |
| Connecting A | Infrabel | L27B | Y Muizen | Muizen Goederen |
| Connecting A | Infrabel | L27B | Muizen Goederen | Muizen Rooster T |
| Principal | Infrabel | L27 | Mechelen | Y Duffel |
| Principal | Infrabel | L13/1 | Y Duffel | Y Lint |
| Principal | Infrabel | L13 | Y Lint | Lier |

| | | | | |
|--------------|----------|--------|------------------------------|------------------------------|
| | | | | |
| Diversiary | Infrabel | L58/1 | Y West Driehoek Ledeborg | Y Noord Driehoek Ledeborg |
| Diversiary | Infrabel | L58 | Y Noord Ledeborg | Gent Dampoort |
| Diversiary | Infrabel | L58 | Gent Dampoort | Gent-Zeehaven |
| Diversiary | Infrabel | L59B | Gent-Zeehaven | Y Bernadettestraat |
| Diversiary | Infrabel | L59 | Y Bernadettestraat | Y.Melsele |
| Diversiary | Infrabel | L59 | Y.Melsele | Y.Zwijndrecht-Fort |
| | | | | |
| Principal | Infrabel | L27A | Antwerpen Noord Inrit C1 | Antwerpen Schijnpoort |
| Principal | Infrabel | L27A | Antwerpen Schijnpoort | Antwerpen-Berchem |
| Principal | Infrabel | L27A | Antwerpen-Berchem | Y.Krijgsbaan |
| Principal | Infrabel | L15/1 | Y.Krijgsbaan | Y Aubry |
| Principal | Infrabel | L15 | Y Aubry | Lier |
| Principal | Infrabel | L15 | Lier | Y Nazareth |
| Principal | Infrabel | L16 | Y Nazareth | Nieuwe Y. Noord Dr. Aarschot |
| Principal | Infrabel | L35 | Nieuwe Y. Noord Dr. Aarschot | Y. Oost Driehoek Aarschot |
| Principal | Infrabel | L35 | Y. Oost Driehoek Aarschot | Hasselt |
| | | | | |
| Connecting A | Infrabel | L21C | Genk Zuid | Bilzen |
| Connecting A | Infrabel | L21A | Hasselt | Genk Goederen |
| Connecting A | Infrabel | L21C | Genk Goederen | Genk Zuid |
| | | | | |
| Principal | Infrabel | L34 | Hasselt | Bilzen |
| Principal | Infrabel | L34 | Bilzen | Y Glons |
| Principal | Infrabel | L24 | Y Glons | Y Berneau |
| Principal | Infrabel | L24 | Y Berneau | Montzen - Block 15 |
| Principal | Infrabel | L24 | Montzen - Block 15 | Montzen border (Botzelaer) |
| | | | | |
| Connecting A | Infrabel | L24/1 | Y Berneau | Visé |
| Connecting A | Infrabel | L40 | Visé | Kinkempois |
| Connecting A | Infrabel | L125/1 | Kinkempois | Renory |
| | | | | |
| Principal | DB Netz | 2552 | Aachen West Grenze | Aachen West Gbf |
| Principal | DB Netz | 2553 | Aachen West Westkopf | Aachen West Pbf |
| Principal | DB Netz | 2550 | Aachen West Gbf | Aachen Hbf |
| Principal | DB Netz | 2600 | Aachen Hbf | Köln-Ehrenfeld Gbf |
| Principal | DB Netz | 2613 | Köln-Ehrenfeld Gbf | Köln West Ws |
| Principal | DB Netz | 2640 | Köln West Ws | Abzw Köln Süd |
| Principal | DB Netz | 2641 | Abzw Köln Süd | Köln Südbrücke Abzw |
| Connecting A | DB Netz | 2641 | Köln Südbrücke Abzw | Köln Kalk Nord Ksf |
| Principal | DB Netz | 2656 | Köln Südbrücke Abzw | Abzw Gremberg Nord |
| | | | | |
| Divisionary | DB Netz | 2510 | Venlo Grenze | Viersen |
| Divisionary | DB Netz | 2520 | Viersen | Mönchengladbach Hbf |
| Divisionary | DB Netz | 2550 | Mönchengladbach Hbf | Rheydt Hbf |
| Divisionary | DB Netz | 2611 | Rheydt Hbf | Köln-Ehrenfeld |
| | | | | |
| Principal | DB Netz | 2270 | Emmerich Grenze | Oberhausen Hbf Obn |
| Principal | DB Netz | 2271 | Oberhausen Hbf Obn | Oberhausen Hbf Obn |
| Principal | DB Netz | 2320 | Oberhausen West Oro | Duisburg Sigle |
| Principal | DB Netz | 2323 | Duisburg Sigle | Duisburg Lotharstrasse |
| Connecting A | DB Netz | 2323 | Duisburg Lotharstrasse | Duisburg Hochfeld Süd |
| Connecting B | DB Netz | 2315 | Duisburg Hochfeld Süd | Duisburg-Wanheim |
| Connecting A | DB Netz | 2505 | Duisburg-Hochfeld Süd | Rheinhausen Logport 1 |
| Connecting A | DB Netz | 2320 | Duisburg Hochfeld Süd | Duisburg-Wedau |

| | | | | |
|---------------|---------|------|--------------------------------------|--------------------------------------|
| Connecting A | DB Netz | 2326 | Duisburg Hochfeld Süd | Duisburg-Wedau |
| Connecting A | DB Netz | 2327 | Duisburg Ruhrort Hafen | Abzw. Mathilde |
| Connecting A | DB Netz | 2302 | Duisburg Ruhrort Hafen | Oberhausen West |
| Connecting A | DB Netz | 2307 | Duisburg Ruhrtal | Duisburg Ruhrort Hafen |
| Principal | DB Netz | 2321 | Oberhausen Hbf Obn | Duisburg-Wedau |
| Principal | DB Netz | 2324 | Duisburg-Wedau | Abzw Koblenz-Pfaffendorf |
| | | | | |
| Connecting A | DB Netz | 2665 | Köln Kalk Nord Einfahrt | Köln Kalk Nord Km |
| Connecting A | DB Netz | 2667 | Köln Kalk Nord Km | Köln Kalk Nord Ksf |
| Connecting A | DB Netz | 2669 | Köln Kalk Nord Knf | Köln Kalk Nord Kw |
| Connecting A | DB Netz | 2666 | Köln Kalk Nord Ksf | Gremberg Gsf |
| | | | | |
| Principal | DB Netz | 2324 | Abzw Koblenz-Pfaffendorf | StrWe 2324/3507 |
| Principal | DB Netz | 3507 | StrWe 2324/3507 | Wiesbaden Ost Gbf Ültg (B) |
| Principal | DB Netz | 3603 | Wiesbaden Ost Gbf Ültg (B) | Abzw Kostheim |
| Principal | DB Netz | 3531 | Abzw Kostheim | Abzw Kostheim Ost |
| Principal | DB Netz | 3525 | Abzw Kostheim | Bft Mainz-Bischofsheim Ültg I |
| Connecting A | DB Netz | 3520 | Mainz Bischofsheim Gbf | Mainz Hbf |
| Principal | DB Netz | 3530 | Mainz-Bischofsheim Ültg | Darmstadt Hbf |
| Principal | DB Netz | 3537 | Abzw Stockschneise | Darmstadt Hbf |
| Principal | DB Netz | 3601 | Darmstadt Hbf | Mannheim-Friedrichsfeld |
| Connecting A | DB Netz | 4060 | Mannheim-Friedrichsfeld | Schwetzingen |
| Connecting A | DB Netz | 4061 | Mannheim-Friedrichsfeld | Mannheim-Friedrichsfeld Südeinf/Ausf |
| Connecting A | DB Netz | 4062 | Mannheim-Friedrichsfeld | Mannheim-Friedrichsfeld Südeinf/Ausf |
| Connecting A | DB Netz | 4050 | Mannheim-Friedrichsfeld Südeinf/Ausf | Mannheim Rbf Westeinfahrt |
| Connecting A | DB Netz | 4002 | Mannheim-Friedrichsfeld Südeinf/Ausf | Mannheim Rbf |
| Connecting A | DB Netz | 4002 | Mannheim Rbf | Mannheim Hbf |
| Connecting A | DB Netz | 4003 | Mannheim Hbf | Mannheim Hbf Ost |
| Connecting A | DB Netz | 4030 | Mannheim Hbf | Mannheim Hgbf |
| Connecting A | DB Netz | 3401 | Mannheim Hbf | Schifferstadt |
| Connecting A | DB Netz | 3400 | Schifferstadt | Germersheim |
| Connecting A | DB Netz | 3403 | Ludwigshafen (Rhein) | Ludwigshafen (Rhein) |
| Connecting A | DB Netz | 3522 | Ludwigshafen Mitte | Ludwigshafen-Oggersheim |
| Connecting A | DB Netz | 4021 | Mannheim Rbf Gr E | Abzw Mannheim-Neckarau |
| Connecting A | DB Netz | 4052 | Mannheim Rbf Gr E | Mannheim Ziehbrunnen |
| | | | | |
| Connecting A | DB Netz | 4020 | Abzw Mannheim-Neckarau | Schwetzingen |
| Connecting B | DB Netz | 4020 | Mannheim Hbf Ost | Abzw Mannheim-Neckarau |
| Principal | DB Netz | 4020 | Schwetzingen | Karlsruhe Hbf |
| | | | | |
| Diversionsary | DB Netz | 4210 | Karlsruhe-Hagsfeld | Karlsruhe Gbf |
| Diversionsary | DB Netz | 4213 | Karlsruhe Gbf | Abzw Brunnenstück |
| Diversionsary | DB Netz | 4214 | Karlsruhe Gbf | Ka-Dammerstock |
| Connecting A | DB Netz | 4215 | Karlsruhe Gbf | Karlsruhe West |
| | | | | |
| Diversionsary | DB Netz | 4020 | Karlsruhe Hbf | Rastatt |
| | | | | |
| Diversionsary | DB Netz | 4280 | Abzw Rastatt Süd | Offenburg Süd |
| Diversionsary | DB Netz | 4280 | Abzw Schliengen Nord | Eimeldingen |
| Diversionsary | DB Netz | 4263 | Abzw Windschläg | Offenburg Süd |
| Diversionsary | DB Netz | 4312 | Abzw Gundelfingen | Freiburg Gbf |
| Diversionsary | DB Netz | 4312 | Freiburg Gbf | Abzw Leutersberg |
| | | | | |
| Principal | DB Netz | 4000 | Karlsruhe Hbf | Basel Bad Bf |
| Diversionsary | DB Netz | 4411 | Weil am Rhein | Basel Bad Rbf (Gr. A) |
| Diversionsary | DB Netz | 4413 | Haltingen | Basel Bad Rbf (Gr. C) |

| | | | | |
|--------------|-----------|---------|--------------------------|--------------------------|
| Diversiary | DB Netz | 4415 | Weil am Rhein | Basel Bad Rbf (Gr. A) |
| Principal | DB Netz | 4404 | Basel Bad Bf | Basel Grenze |
| Diversiary | DB Netz | 4405 | Basel Bad Rbf (Gr. C) | Basel Bad Rbf BW/CH 4405 |
| Diversiary | DB Netz | 4405 | Basel Bad Rbf BW/CH 4405 | Gellert |
| Diversiary | DB Netz | 4407 | Gellert | Basel Grenze Muttenz |
| | | | | |
| Divisionary | DB Netz | 2304 | Duisburg Meiderich Ost | Oberhausen West |
| Divisionary | DB Netz | 2331 | Abzw Mathilde | Abzw Meerbeck |
| Divisionary | DB Netz | 2330 | Abzw Meerbeck | Trompet |
| Divisionary | DB Netz | 2340 | Trompet | Abzw Mühlenberg |
| Divisionary | DB Netz | 2342 | Abzw Mühlenberg | Krefeld-Uerdingen |
| Connecting A | DB Netz | 2504 | Krefeld-Uerdingen | Abzw Lohbruch |
| Connecting A | DB Netz | 2610 | Abzw Lohbruch | Abzw Weißenberg |
| Connecting A | DB Netz | 2531 | Abzw Weißenberg | Neuss Gbf |
| Connecting A | DB Netz | 2534 | Neuss Gbf | Neuss Vorbf |
| Connecting A | DB Netz | 2531 | Neuss Gbf | Abzw Neuss Nordkanal |
| Connecting A | DB Netz | 2610 | Abzw Neuss Nordkanal | Köln-Longerich |
| Connecting A | DB Netz | 2615 | Köln-Longerich | Köln West Wf |
| | | | | |
| Connecting A | DB Netz | 2643 | Köln Bonntor | Köln Eifeltor Esf |
| Connecting A | DB Netz | 2640 | Abzw Köln Süd | Hürth-Kalscheuren |
| Connecting A | DB Netz | 2630 | Hürth-Kalscheuren | Koblenz Hbf |
| | | | | |
| Connecting A | DB Netz | 3011 | Neuwied Gbf | Koblenz-Lützel Nord |
| Connecting A | DB Netz | 3710 | Koblenz Hbf | Niederlahnstein |
| | | | | |
| Divisionary | DB Netz | 2630 | Koblenz Hbf | Bingen (Rh) Hbf |
| Divisionary | DB Netz | 3510 | Bingen (Rh) Hbf | Mainz-Mombach |
| Divisionary | DB Netz | 3525 | Mainz-Mombach | Abzw Kostheim Ost |
| | | | | |
| Principal | SBB Infra | 700 | Gellert | Basel SBB RB |
| Connecting A | SBB Infra | | Basel SBB RB | Kleinhüningen |
| Connecting A | SBB Infra | | Basel SBB RB | Birsfelden Hafen |
| Principal | SBB Infra | 700 | Basel SBB RB | Pratteln |
| Connecting A | SBB Infra | | Pratteln | Reckingen |
| | | | | |
| Divisionary | SBB Infra | 500 | Muttenz | Liestal via Adlertunnel |
| Divisionary | SBB Infra | 500 | Pratteln | Olten VL |
| Connecting A | SBB Infra | 550/650 | Olten VL | Rupperswil |
| Connecting A | SBB Infra | 653 | Rupperswil | Hendschiken |
| | | | | |
| Principal | SBB Infra | 500 | Pratteln | Olten |
| Principal | SBB Infra | 450 | Olten | Rothrist |
| Principal | SBB Infra | 450 | Rothrist | Mattstetten via NBS |
| Principal | SBB Infra | | Rothrist | Mattstetten via Burgdorf |
| Principal | SBB Infra | 450 | Mattstetten | Bern VL |
| Principal | SBB Infra | 290 | Bern VL | Thun |
| | | | | |
| Principal | SBB Infra | 700 | Pratteln | Brugg VL |
| Connecting A | SBB Infra | | Brugg | Zürich Limmathal |
| Principal | SBB Infra | 654 | Brugg VL | Hendschiken |
| Principal | SBB Infra | 653 | Hendschiken | Arth-Goldau |
| Principal | SBB Infra | 600 | Arth-Goldau | Giubiasco |
| Principal | SBB Infra | 631 | Giubiasco | Pino Tronzano (Luino) |
| Principal | SBB Infra | 600 | Giubiasco | Balerna |
| Principal | SBB Infra | | Balerna | Chiasso SM / Chiasso Vg |

| | | | | |
|---------------|-----------|-------|----------------------|-------------------------|
| | | | | |
| Principal | SBB Infra | 310 | Thun | Thun Scherzlingen |
| Principal | BLS Infra | 310 | Thun Scherzlingen | Spiez |
| Principal | BLS Infra | 300 | Spiez | Wengi-Ey |
| | | | | |
| Principal | BLS Infra | 300 | Wengi-Ey | Frutigen |
| Principal | BLS Infra | 300 | Frutigen | Abzw. Brig |
| | | | | |
| Principal | BLS Infra | 330 | Wengi-Ey | St. German |
| Principal | SBB Infra | 100 | St. German | Abzw. Brig |
| | | | | |
| Principal | SBB Infra | 100 | Abzw. Brig | Brig |
| Principal | SBB Infra | 100 | Brig | Confine CH-I |
| Principal | SBB Infra | 100 | Confine CH-I | Portal Nord Sempioncino |
| | | | | |
| Principal | RFI | | Confine CH-IT | Iselle |
| Principal | RFI | | Iselle | Domodossola |
| Connecting A | RFI | 1000 | Domodossola | Bivio Toce |
| Connecting A | RFI | 1000 | Bivio Toce | Domo II |
| Connecting A | RFI | 1000 | Domo II | Bivio Valle |
| | | | | |
| Diversionsary | RFI | 1000 | Domodossola | Pieve Vergonte |
| Diversionsary | RFI | 1000 | Pieve Vergonte | Premossello |
| | | | | |
| Principal | RFI | 3540 | Domodossola | Premossello |
| Diversionsary | RFI | 31621 | Premossello | Caltignaga |
| Diversionsary | RFI | 31620 | Caltignaga | Vignale |
| | | | | |
| Principal | RFI | 390 | Premossello | Arona |
| Principal | RFI | 32630 | Arona | Oleggio |
| Principal | RFI | 32584 | Oleggio | Vignale |
| | | | | |
| Principal | RFI | 31270 | Vignale | Novara |
| Connecting A | RFI | 1000 | Novara | Novara Boschetto |
| Principal | RFI | 341 | Novara | Mortara |
| Connecting A | RFI | 1000 | Mortara | Mortara Smistamento |
| Principal | RFI | 341 | Mortara | Torreberetti |
| Principal | RFI | 342 | Torreberetti | Valenza |
| Principal | RFI | 343 | Valenza | Alessandria |
| Principal | RFI | 32562 | Alessandria | Ovada |
| Principal | RFI | 32561 | Ovada | Genova Borzoli |
| Connecting A | RFI | 31923 | Genova Borzoli | Genova Voltri Mare |
| Principal | RFI | 32561 | Genova Borzoli | B. Polcevera |
| Principal | RFI | 32561 | B. Polcevera | Genova Sampierdarena |
| Connecting A | RFI | 32561 | Genova Sampierdarena | Genova Marittima |
| | | | | |
| Principal | RFI | 330 | Alessandria | Frugarolo |
| Principal | RFI | 3751 | Frugarolo | Novi Ligure |
| Principal | RFI | 3752 | Novi Ligure | Arquata Scrivia |
| | | | | |
| Principal | RFI | 31165 | Chiasso | Bivio Rosales |
| Principal | RFI | 31161 | Chiasso | Como S. Giovanni |
| Principal | RFI | 31162 | Como S. Giovanni | Albate Camerlata |
| Principal | RFI | 31163 | Albate Camerlata | Bivio Rosales |
| Principal | RFI | 31164 | Bivio Rosales | Seregno |
| Principal | RFI | 31169 | Seregno | Monza |

| | | | | |
|--------------|-----|-------|-------------------|-----------------------|
| Principal | RFI | 31171 | Monza | Milano Lambrate |
| Connecting A | RFI | 31171 | Milano Lambrate | Milano Smistamento |
| Principal | RFI | 1000 | Milano Lambrate | Milano Rogeredo |
| Principal | RFI | 32401 | Milano Rogeredo | Pavia |
| Principal | RFI | 32402 | Pavia | Bressana |
| Principal | RFI | 32403 | Bressana | Voghera |
| Principal | RFI | 32130 | Voghera | Tortona |
| Principal | RFI | 3110 | Tortona | Arquata Scrivia |
| Principal | RFI | 31770 | Arquata Scrivia | Ronco Scrivia |
| Principal | RFI | 32780 | Ronco Scrivia | Bivio / PC Fegino |
| Principal | RFI | 31923 | Bivio / PC Fegino | Genova Sanpiederarena |
| Connecting A | RFI | 32750 | Milano Lambrate | Melzo Scalo |
| Connecting A | RFI | 3771 | Arona | Sesto Calende |
| Connecting A | RFI | 3772 | Sesto Calende | Gallarate |
| Connecting A | RFI | 31701 | Gallarate | Busto Arsizio |
| Connecting A | RFI | 31702 | Busto Arsizio | Rho |
| Connecting A | RFI | 31130 | Rho | Milano Certosa |
| Connecting A | RFI | 1000 | Milano Certosa | Milano Lambrate |
| Connecting A | RFI | 32581 | Luino | Laveno |
| Connecting A | RFI | 32590 | Laveno | Gallarate |
| Connecting A | | | | |
| Connecting A | RFI | 32582 | Laveno | Sesto Calende |
| Connecting A | RFI | 32583 | Sesto Calende | Oleggio |
| Connecting A | RFI | 241 | Voghera | Piacenza |
| Connecting A | RFI | 31052 | Piacenza | Milano Rogeredo |

| |
|----------------|
| Expected lines |
|----------------|

| | | | | |
|----------|-----------|------|-----------------------|-----------------------|
| Expected | ProRail | | Budel Grens | Weert |
| Expected | ProRail | | Weert | Vlodrop Grens |
| Expected | Infrabel | | Liefkenshoektunnel | |
| Expected | Infrabel | L15 | Y Nazareth | Mol |
| Expected | Infrabel | L19 | Mol | Hamont border |
| Expected | DB Netz | 2524 | Dalheim Grenze | Dalheim |
| Expected | DB Netz | 2524 | Dalheim | Rheydt Gbf |
| Expected | DB Netz | 2279 | Emmerich Grenze | Emmerich |
| Expected | DB Netz | 4280 | Offenburg Süd | Lahr |
| Expected | DB Netz | 4280 | Lahr | Riegel |
| Expected | DB Netz | 4280 | Riegel | Gottenheim / Freiburg |
| Expected | DB Netz | 4280 | Gottenheim / Freiburg | Bad Krozingen |
| Expected | DB Netz | 4280 | Bad Krozingen | Mülheim |
| Expected | DB Netz | 4280 | Mülheim | Basel |
| Expected | DB Netz | | Rhein/Main | Rhein/Neckar |
| Expected | SBB Infra | | Erstfeld | Biasca |

| | | | | |
|----------|-----------|--|-------------|-------------|
| Expected | SBB Infra | | Giubiasco | Vezia |
| Expected | RFI | | Seregno | Carnate |
| Expected | RFI | | Carnate | Treviglio |
| Expected | RFI | | Treviglio | Cremona |
| Expected | RFI | | Cremona | Castelvetro |
| Expected | RFI | | Castelvetro | Piacenza |
| Expected | RFI | | Piacenza | Voghera |
| Expected | RFI | | Arquata | Genoa |

Table 12: List of corridor lines