

Client: Nederlandse Aardolie
Maatschappij

**Arup Project Title: Groningen
2013**

Structural Upgrading Study

REP/229746/SU003

Issue | 29 November 2013

This report was prepared by Arup in November 2013 on the basis of a scope of services agreed with our client. It is not intended for and should not be relied upon by any third party and no responsibility or liability is undertaken to any third party.

Job number 229746
External Ref EP201311204036

Arup bv
PO Box 57145
1040 BA
Amsterdam
The Netherlands
www.arup.com

This document is scientific work and is based on information available at the time of writing. Work is still in progress and the contents may be revised during this process, or to take account of further information or changing needs. This report is in the public domain only for the purpose of allowing thorough scientific discussion and further scientific review. The findings are only estimated outcomes based upon the available information and certain assumptions. We cannot accept any responsibility for actual outcomes, as events and circumstances frequently do not occur as expected.

ARUP

Contents

	Page
Executive Summary	i
1 Introduction	1
1.1 Background	1
1.2 Structural Upgrading Strategy	2
1.3 Structural Upgrading Study and Pilot 1	3
1.4 Report Outline	4
2 Design Methodology	5
2.1 Development of Design Methodology	5
2.2 Performance Requirements	13
2.3 Seismic Evaluation	17
2.4 Components of Seismic Evaluation	21
2.5 Analysis Methodology	27
2.6 Development of Legal and Regulatory Framework	34
3 Scope of Study	36
3.1 Building Typologies	36
3.2 Selected Buildings: Pilot 1 Phase 1	42
3.3 Building Element Studies	44
4 Results	45
4.1 Seismic Performance – Building Level	45
4.2 Seismic Performance – Building Element Level	54
4.3 Seismic Performance – Influence of Analysis Method	57
4.4 Structural Upgrading Measures	66
4.5 Duration Studies	79
5 Uncertainties and Uncertainty Reduction	80
5.1 Uncertainties	80
5.2 Reduction of Uncertainties	90
6 Conclusions	94
6.1 Design Methodology	94
6.2 Analysis Methodology	94
6.3 Seismic Performance - Building Level	95
6.4 Seismic Performance - Building Element Level	98
6.5 Structural Upgrading Measures	99
6.6 Research and Investigations	100

7	Recommendations	101
7.1	Design Methodology and Development of Design Guidance	101
7.2	Analysis Methodology	101
7.3	Structural Upgrading Measures	102
7.4	Research and Investigations	102

Appendix A

Seismic-Resistant Design

Appendix B

Strategies to Improve Structural Performance

Appendix C

Typical Building Typology Photographs

Appendix D

Glossary

Executive Summary

1. Introduction

The report provides a summary of the Structural Upgrading Study for existing buildings in the Groningen region. This report forms part of a wider scope of services and supports the Structural Upgrading Strategy^[1] for buildings in the Groningen region. It is one of the studies for building damage reduction as outlined in the letter of Minister Kamp to the Dutch Parliament of 11 February 2013. The Structural Upgrading Strategy is supported by three studies:

- Structural Upgrading Study;
- Seismic Risk Study ^[2]; and
- Implementation Study ^[3].

2. Objectives

The objective of the Structural Upgrading Study is to develop design guidance for structural upgrading of the Groningen region building stock within the context of Dutch building practice and the available regulatory framework. This design guidance takes the format of design rules and protocols for so-called ‘typical’ buildings (e.g. terraced houses), representative of a large proportion of buildings, and design procedures for unique buildings (e.g. office buildings) or those of special importance (e.g. hospitals or schools).

The design guidance to be developed is aimed at life safety. This protection of life is incorporated by performance requirements in the design codes.

The focus of the study has been on buildings constructed from unreinforced masonry (URM) which were not originally designed for seismic resistance and are particularly susceptible to seismic action, as is indicated by the fragility curves of URM buildings when compared with buildings of other materials.

3. Study Approach

At present, structural upgrading measures for the protection of life safety have been studied and developed to concept design level for buildings, on the basis of a seismic hazard generating peak ground acceleration at surface (PGA) of up to 0.5g. It should be noted that field instrumentation equipment is being installed and additional research and investigations are being performed to improve the reliability of the seismic design data.

This study assesses the performance of selected buildings representing typical, damaged, historical, and other buildings. To date, 16 buildings have been assessed:

- Eight typical buildings of six sub-typologies:
 - terraced house
 - semi-detached house
 - detached house

- labourer's cottage
- mansion
- villa
- Four damaged buildings;
- One historic church; and
- Three other buildings:
 - one school
 - two utility buildings

Modal response spectrum analyses have been used for all selected buildings as this is the default analysis method recommended by the seismic design codes. For the church a non-linear mechanism-based approach has been used, as this approach shows good prediction of failure mechanisms in historic buildings. For two typical sub-typologies – the detached house and the terraced house - further analysis methods have been used to investigate the sensitivity of the outcomes to the analysis methodology. These include the lateral force analysis, the equivalent frame method, the non-linear macro element method and the non-linear time-history analysis. The detached house and the terraced house are representative of respectively the less vulnerable and more vulnerable sub-typologies in typical buildings.

For all buildings studied ties between walls, floors and the roof, and floor stiffening were assumed. This takes into account upgrading levels 2 and 3 (as defined on page v) as a significant number of buildings may not have these ties and have flexible floors. Whether these two upgrading levels are needed in all buildings will be the subject of additional investigations.

4. Discussion of Results

Seismic building performance

Relative performance

Although the number of typical buildings studied is limited, the following factors are seen to influence building performance:

- Wall openness (e.g. windows and doors);
- Wall type; and
- Building mass (which is a function of mass of floor construction and number of storeys).

Based on the Modal response spectrum analyses, two groups are distinguished:

- **The more vulnerable** typical building sub-typologies, comprising terraced houses and semi-detached houses; and
- **The less vulnerable** typical building sub-typologies, comprising detached houses, labourer's cottages, mansions and villas.

The more vulnerable typical building sub-typologies are directional in their structural configuration and performance and are particularly vulnerable in the direction parallel to the front and rear façades. These façades are relatively open.

This wall openness originates from a design methodology commonly used to design these buildings for resistance to wind load on the gables, which resulted in relatively narrow masonry piers per terraced house to resist lateral loads in that direction. In this group all the buildings are three storey buildings and all walls are cavity walls. Buildings with relatively light floors perform better compared to buildings with relatively heavy floors.

The less vulnerable typical building sub-typologies are non-directional. In this group most buildings are two-storey buildings and most buildings have solid walls. Again, buildings with relatively light floors perform better compared to buildings with relatively heavy floors.

Buildings with shop fronts, though not explicitly studied, are expected to perform similarly to more vulnerable typical building sub-typologies based on similar structural arrangements of load-bearing members.

Note that the differentiation in more and less vulnerable buildings has not yet been made in the fragility curves used in the Seismic Risk Study. At present, the fragility curves represent a statistical representative estimate for all buildings with a differentiation only according to age. When more information becomes available about relative vulnerability this will be taken into account in the Seismic Risk Study.

Life safety performance

When upgrading measures 2 and 3 are assumed to be implemented on the buildings studied, the threshold for partial collapse (Damage State 4 = DS4), such as wall failure, is used to assess life safety performance (probability of casualties from DS4 is relatively low).

The Modal response spectrum analyses show partial collapse (DS4) at PGA's smaller than 0.1g. This is not consistent with the experience at the Huizinge earthquake where maximum observed component PGA's of 0.08g were measured and the only damage observed was cracks in walls (DS1 and DS2).

Non-linear analyses show partial collapse (DS4) for PGA's between 0.15g to 0.5g dependent on building sub-typology and non-linear analysis method. For the sub-typologies studied – terraced houses and detached houses - partial collapse was observed at PGA's of respectively 0.3g and 0.5g on the basis of sophisticated non-linear time history analyses. Using more simple non-linear pushover analysis, partial collapse was observed between 0.16g and 0.24g on the detached house sub-typology.

Definite conclusions about structural upgrading beyond level 3 is difficult, although these preliminary results show that the threshold where upgrading beyond level 3 is needed is tentatively between 0.15g and 0.5g. To be more confident the non-linear analyses need calibration with physical laboratory tests.

Design methodology

In the absence of a regulatory framework for seismic design in the Netherlands, international guidance/codes have been reviewed and a methodology has been developed that combines the applicable Eurocode 8 and the American Society of Civil Engineering (ASCE) approaches. ASCE 41-13 Seismic Evaluation and Retrofit of Existing Buildings^[13] is currently in draft form and expected to be released early in 2014. It represents the state-of-the-art of engineering knowledge in the assessment of URM structures under seismic action. This is an area in which the Eurocode 8 does not incorporate the most up to date guidance. Earthquakes in the Groningen area are induced and of much smaller magnitude and duration than the large tectonic earthquakes on which the guidance in ASCE 41-13 has been based. Consequently, research into the background data and test results of ASCE 41-13 has been undertaken to test the applicability to the Dutch building stock and additional research has been identified (i.e. rocking mechanisms and out-of-plane stability of slender walls) to develop specific guidance to be applicable in the Groningen region.

Analysis methodology

Several analysis methodologies have been investigated as part of the study to test their validity and accuracy to different building typologies. The aim in each case has been to strike an appropriate balance between accuracy and speed of assessment. From the study it is concluded that different methodologies may be used for different building typologies.

For low levels of PGA or when performance requirements are linked to no or negligible damage (DS0 and DS1) a linear-elastic analysis can be used in an accurate way.

For larger PGA's and with the acceptance of significant damage (DS4) for performance requirements associated with life safety, a non-linear analysis can take into account the non-linear more ductile response of the building and is required in order to achieve more accurate results and hence better insight in required upgrading measures. This is especially the case when the analysis is for a special building or is representative for a typology or sub-typology, representing a larger proportion of buildings.

For larger PGA's an alternative approach is to use a linear-elastic analysis, together with ductility factors based on material, (sub) typology or failure mode. These ductility factors are not available for the Groningen building stock, while currently codified ductility factors give limited ductility for URM buildings or building parts. After calibration through physical and numerical non-linear testing, a linear analysis methodology that takes into account the representative ductility of the Groningen building stock may provide a more efficient overall procedure. This methodology may be more appropriate for general, large-scale deployment within the engineering community. Development of such simplified method may take one to three years.

Structural upgrading measures

The results from the analyses and assessments determine the requirement for upgrading measures. Feasible preliminary structural upgrading measures and

options suitable for local implementation have been developed for each building investigated. These measures have been proposed as being appropriate to prevent life-threatening damage and are developed taking due consideration of local capabilities, social disturbance and aesthetic sensitivity. Seven levels of permanent upgrading measures have been characterised within the study. Commencing at level 1, the upgrading levels have been set out in order of the most effective solutions that can be deployed most rapidly to reduce risk most quickly whilst minimising impact for inhabitants. Complexity, duration and impact on inhabitants increase with increasing intervention level.

When intervention is required this will be a mix of different permanent and temporary upgrading measures.

Permanent upgrading measures – intervention levels:

- **Level 1:** Mitigation measures for higher risk building elements (potential falling hazards);
- **Level 2:** Tying of floors and walls;
- **Level 3:** Stiffening of flexible diaphragms;
- **Level 4:** Strengthening of existing walls;
- **Level 5:** Replacement and addition of walls;
- **Level 6:** Foundation strengthening; and
- **Level 7:** Demolition.

Temporary upgrading measures have also been identified for specific building types for rapid risk reduction, for example terraced houses, semi-detached houses and shop front buildings which have been identified as being more vulnerable. Temporary upgrading measures are exterior to the building and provide lateral support to the building (e.g. steel “bookend” frames). Temporary upgrading is to be considered for these buildings to mitigate short-term risk until permanent solutions are available.

A key consideration under investigation is the seismic hazard threshold below which no intervention is required. The determination of this threshold is under development and will be investigated based on analyses and physical testing. The current expectations are that this threshold will be for PGA’s of 0.1g to 0.2g, based on observation in other countries with comparable URM building stock.

5. Recommendations

Design methodology and development of design guidance

In the long-term it is recommended to develop the National Annex for Eurocode 8 that incorporates design guidance for structural upgrading of the Groningen building stock within the context of Dutch building practice. It is recommended that this will take into account the specifics of the Groningen building stock, the specific seismic hazard in the Groningen region and a specific target safety level for the Netherlands in respect to life safety in relation to seismic events.

As the National Annex will take time to develop it is recommended for the short-term to adopt a design basis for structural upgrading that is a combination of Eurocode 8 and ASCE 41-13.

This short-term design basis can serve as a basis for the Nationale Praktijk Richtlijn (NPR), the precursor of the National Annex. Purpose of this NPR is to give practical design guidance in absence of a National Annex.

As knowledge is expected to develop quickly it is recommended to update the short-term design basis each year and to incorporate this knowledge into the NPR.

As the Structural Upgrading Strategy is a stepwise approach that starts with the pilot and implementation of permanent measures levels 1 to 3 and temporary measures, it is recommended to develop more specific guidance for these measures before the first version of the NPR becomes available in the spring of 2014.

Analysis methodology

In the short-term it is recommended to use non-linear analysis for the assessment of building performance for larger PGA's and performance criteria that accept damage, in order to take the beneficial non-linear behaviour of the buildings into account. In general, it is recommended not to use linear-elastic analysis in combination with currently codified ductility factors for the assessment of building performance, as this will produce conservative results. The use of linear-elastic analysis is recommended for low PGA's, or with performance criteria that do not accept any or negligible damage.

In the long-term, if and when codified ductility factors are established for the Groningen building stock, the use of linear-elastic analysis is recommended. This will imply the development of ductility factors for building typologies and sub-typologies.

Structural upgrading measures

In the short-term it is recommended to focus on the development of detailed permanent and temporary structural upgrading measures for the more vulnerable typical building sub-typologies.

In the short-term it is recommended to focus on structural upgrading measures 1 to 3 and temporary measures.

Uncertainty reduction

High levels of uncertainties exist in the definition of the seismic hazard; structural capacity and target level of safety. These are too high at present for making reasonable and defensible decisions in a traditional way about the number and level of interventions required and the planning associated with this. Therefore, the current approach is based on stepwise risk reduction, in which steps of intervention and uncertainty reduction are undertaken in a prioritised and systematic manner through research and investigations. The studies relating to the structural resistance have been discussed in this report. Uncertainties are expected

to reduce in the coming three years as more information and the outcomes of investigations become available.

Research and investigations

To reduce model uncertainties in seismic action, seismic resistance and target safety level it is recommended to undertake additional research and investigations. For the seismic resistance/vulnerability, the aim is to better understand the influencing factors and the influence of different levels of structural upgrading and specifically the different types of upgrading.

In the short term the following research/investigations are proposed:

- **Improve structural analysis and model methodologies:** extended comparisons to find a feasible methodology with the right balance of time/knowledge requirements and accuracy for assessment of forces and/or damage;
- **Calibration of models by laboratory testing** using full scale or scaled physical models of buildings, building parts and material testing. These studies aim to calibrate the analysis methodologies and model assumptions;
- **Calibration of models using field measurements** of ground motion, related building damage and ground settlement on existing buildings in Groningen;
- **Improve fragility curves** for local building stock: production of a methodology to produce fragility curves using analytical non-linear models in combination with laboratory testing;
- **Building / soil structural interaction;**
- **Duration effects:** extension of non-linear finite element calculations on 3D models of buildings, non-linear single degree of freedom models to study duration effects;
- **Testing of specific building elements or structural upgrading measures** by using non-linear static and non-linear dynamic model approaches in combination with physical laboratory tests;
- **Building stock variability** study to improve understanding in-plan and elevation geometry, material properties and detailing; and
- **Ground motion characteristics and local ground conditions.**

1 Introduction

1.1 Background

Arup has been appointed by Nederlandse Aardolie Maatschappij B.V. (NAM) to carry out consultancy services in relation to induced seismic hazard and risk assessment, and the design of structural upgrading measures for buildings in the Groningen region of the Netherlands.

Arup is a global firm of professional consultants. This report has been commissioned by NAM, and produced using information, instructions and directions from NAM. However the findings reached are the product of our independent professional judgement, on the basis of our scientific knowledge at the date of writing this report.

Preventive structural upgrading for existing buildings is applied in several seismic regions around the world, mostly on the initiative of building owners, but also backed up with local or national legislation.

The Groningen situation is unique as (and for this reason examples from other regions cannot simply be copied):

- The earthquakes are caused by gas extraction, known as induced earthquakes;
- There is very limited knowledge and experience in the Dutch building industry in the design and construction of earthquake resistant buildings and the structural upgrading of existing buildings; and
- Most of the building stock in Groningen consists of unreinforced masonry (URM) including specific details related to the Dutch context (i.e. cavity walls), which in general, without special design features, has a poor response to earthquakes.

For the original scope of work for the earthquake scenario-based risk assessment, Arup was requested to consider a study area with a 15 km radius around the epicentre of the August 2012 Huizinge earthquake. As more information became available on the location of induced earthquakes in the Groningen region, the scope of work was increased and the study area was expanded to cover the full extent of the Groningen gas field. The spatial extent of the extended study area is shown on Figure 14.

The results of the Structural Upgrading Study may be an input for the Nationale Praktijk Richtlijn (NPR), which will provide practical seismic design guidance for the Groningen region and is currently being developed by the NEN-institute.

There are numerous uncertainties regarding the seismic hazard and the capacities of the buildings to resist seismic effects. These are captured in the following sections together with the studies and investigations underway or planned to refine the knowledge and reduce uncertainties over time.

1.2 Structural Upgrading Strategy

The Structural Upgrading Study is a component of the three studies underlying the Structural Upgrading Strategy. The three studies consist of:

- Structural Upgrading Study;
- Seismic Risk Study; and
- Implementation Study.

The approach taken to determine the Structural Upgrading Strategy has four basic elements:

- **Stepped implementation** approach for risk reduction with screening/assessments and steps of interventions;
- **Prioritisation** by seismic risk;
- (extended) **Studies** to reduce uncertainties; and
- **Implementation pilots** to test technical feasibility (Pilot 1) and operational implementation (Pilot 2).

Figure 1, below, shows the four basic elements and their relationships.

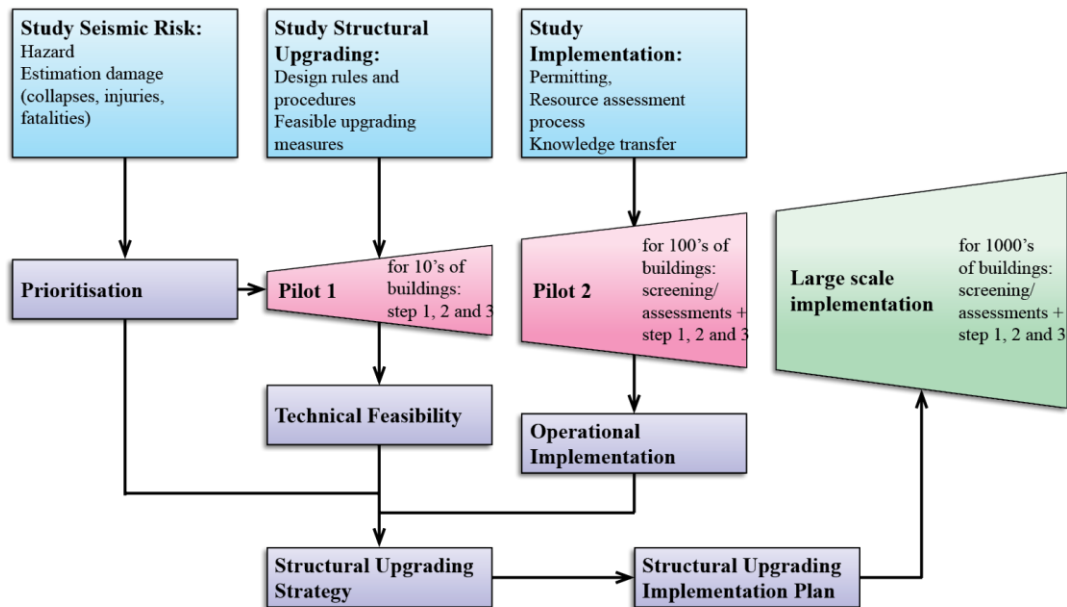

Figure 1 Elements of the strategy and their relations (numbers are indicative)

1.3 Structural Upgrading Study and Pilot 1

The objective of the Structural Upgrading Study is to develop design guidance for structural upgrading of the Groningen building stock within the context of Dutch building practice and the available regulatory framework. This design guidance takes the format of design rules and protocols for so-called ‘typical’ buildings (e.g. terraced houses), representative of a large proportion of buildings, and design procedures for unique buildings (e.g. office buildings) or those of special importance (e.g. hospitals or schools).

The Structural Upgrading Study has been divided into several studies for different building typologies:

- Typical buildings;
- Damaged buildings;
- Historical Buildings; and
- Other Buildings.

Some of these building typologies have sub-typologies that are representative for tens, hundreds or thousands of buildings and can therefore be seen as typical and representative of the types of buildings in the Groningen region.

The Structural Upgrading Study has the following steps:

- Assess the performance of buildings and building types during seismic loading;
- Develop design procedures, design rules and protocols for structural upgrading; and
- Develop feasible structural upgrading measures for local implementation.

In Pilot 1, the structural upgrading measures will be developed based on the results of the structural analyses performed on these building typologies and thereafter tested on tens of buildings in order to verify the technical feasibility of the measures. Pilot 1 consists of a concept design phase (phase 1) and execution phase (phase 2). The execution phase includes a detailed design.

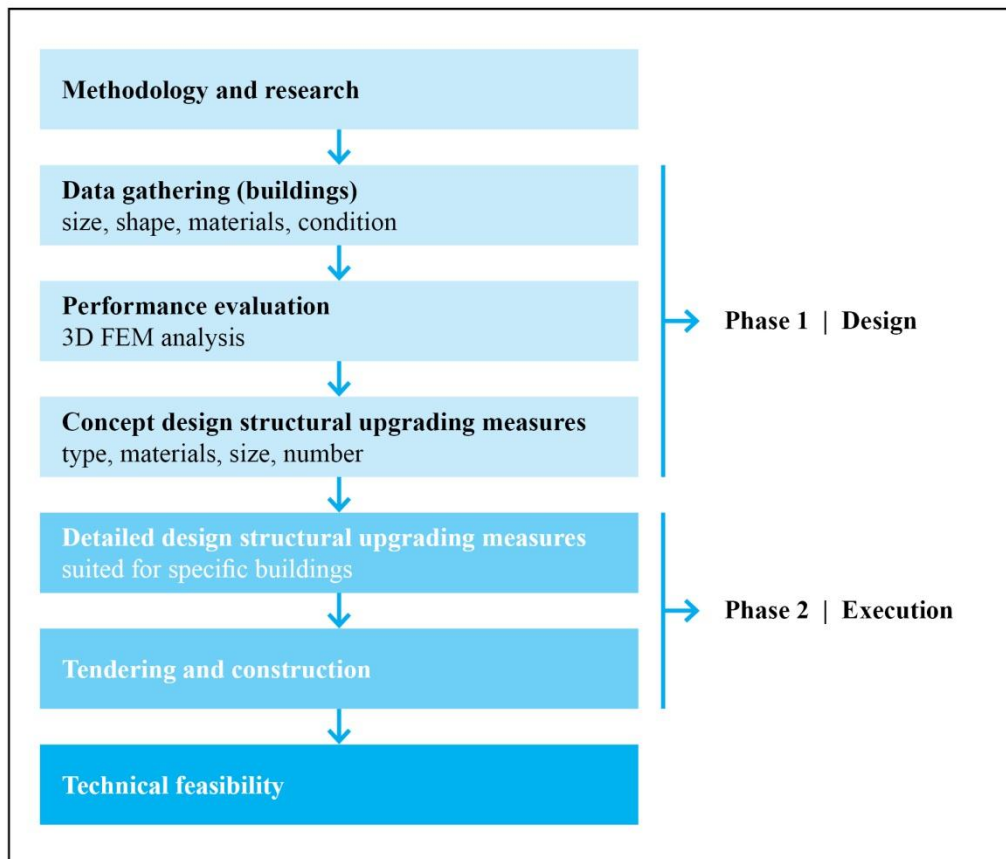

Figure 2 Structural Upgrading Study Process.

1.4 Report Outline

This report is divided into the following sections that comprise the Structural Upgrading Study:

- Design Methodology;
- Scope of Study;
- Results;
- Uncertainties and Uncertainty Reduction;
- Conclusions; and
- Recommendations.

2 Design Methodology

The objective of this section is to describe the development of the design methodology, the definition of seismic performance requirements, definitions of the seismic evaluation, evaluation of analysis methodologies and the development of the legal and regulatory framework.

2.1 Development of Design Methodology

For the development of a methodology, the following definition of target seismic safety is used:

$$\textit{Seismic action} < \textit{Seismic resistance}$$

For the Structural Upgrading Study, models were developed for:

- Seismic action; and
- Seismic resistance.

Refer to Appendix A for more detailed information regarding seismic resistant design.

2.1.1 Aim

The ultimate aim is to develop a methodology for the seismic assessment of existing buildings in the Groningen region and the design of structural upgrading measures. These measures should be capable of being implemented rapidly to reduce risk to life safety and impact on occupants.

The developed guidance will input into, and align with the forthcoming national guidelines currently being prepared by the NEN-institute.

2.1.2 Development criteria

In the development of the design methodology, the following aspects have been taken into account:

- Ability to select different performance levels for different types of buildings (see Section 2.2.2);
- Possibility of integration into the legal framework of codes:
 - Eurocode 8 (EN-1998)*
 - NEN 8700 for existing buildings
- The design method should be based as much as possible on existing codified knowledge in order to ease understanding and acceptance;
- The design method should be adaptable to the local situation, legal requirements and to new insights and knowledge;
- The design method should be practical and quickly developed so that the methodology can be tested in Pilot 1 Phase 1; and
- The design method should be integrating state-of-the-art knowledge on unreinforced masonry and structural upgrading measures.

- The design method should take into account the ability to reasonably and practically implement modifications to the existing housing stock.

* Not valid (yet) in the Netherlands due to the lack of a National Annex

2.1.3 Options for using existing codes

Seismic risk for both new and existing buildings is controlled by the use of design codes, standards and published guidelines that set out acceptable seismic performance and methods for demonstrating compliance with these objectives. The main objective of these documents is to ensure that, in case of a design seismic event, humans are protected, damage is limited and important buildings remain operational.

Current seismic design guidelines are mostly performance-based.

This means that different performance levels, objectives and criteria apply. Different guidelines have different performance objectives that are linked to national legislation. In general, different performance objectives apply for new and existing buildings.

The random nature of seismic events makes it impossible to assure the performance objectives for a specific seismic event, but performance objectives can be assured in probabilistic terms. In practice, for each performance objective the seismic action is associated with a probability of exceedance.

Most current design guidelines that cover seismic design aim to exploit the ductility of structures and materials and their ability to dissipate the seismic energy introduced into the structure. In order to ensure this, brittle failure and the premature formation of unstable mechanisms should be avoided.

Several international seismic design codes, standards and published guidelines were considered for this study. These are discussed in the following sections. Table 1 summarises the international guidelines considered, their relevance to the Groningen context, and their use in the methodology described in this report.

Table 1 International seismic design codes considered

Reference	Relevance	Use in this Study
Eurocode 8 Parts 1 and 3	Developed for use in European context, and will be basis of Dutch NPR. Incomplete guidance on linear and nonlinear acceptance criteria for masonry structures.	Elastic response spectrum. q-factor approach for connection forces and foundation loads.
ASCE 41-13	Calibrated for American seismic hazard and building stock. Detailed guidance for several analysis methodologies and acceptance criteria for masonry structures. Up to date with recent research.	Acceptance criteria for in-plane and out-of-plane response of masonry walls. Guidance on various analysis procedures. Multiple tier assessment approach.
NZSEE^[10]	Calibrated for New Zealand seismic hazard and building stock. Limited guidance on modelling masonry structures. Useful guidance on out-of-plane response of walls and stiffness of timber floors.	Not currently used, although out-of-plane response calculation is currently being evaluated.

2.1.3.1 Eurocode 8

The design of buildings in seismic zones of the European Union is covered by Eurocode 8 (EN 1998). Together with Eurocodes 0 to 7 and 9 (EN 1990 to EN 1997 and EN 1999), they cover the design of new and existing buildings.

In cases of low seismicity ($a_g < 0.08g$ or $a_g S < 0.1g$), reduced or simplified design procedures can be applied. In cases of very low seismicity ($a_g < 0.04g$ or $a_g S < 0.05g$), Eurocode 8 does not have to be applied ($a_g S$ is defined, as the spectral acceleration at $T=0$ of the design spectrum, where a_g is the design ground acceleration on type A ground as S is the soil factor).

Each Eurocode needs a National Annex. In the Netherlands, all Eurocodes are in use and have a National Annex with the exception of Eurocode 8.

The Eurocode 8 provides simplified design procedures for so-called “simple masonry buildings”. To qualify as a “simple building”, the building must comply with criteria that assign limits to plan irregularities and wall configurations and assign minimum dimensions and specific detailing. If a building configuration complies with these simple building criteria, a simple calculation can be produced to assess the earthquake resistance of the building. Figure 3 overleaf shows an outline of these criteria that only apply to a smaller proportion of the buildings in the Groningen region. However, these simplified provisions are limited to $a_g S < 0.20g$.

The seismic assessment and design of structural upgrading of existing buildings is covered in the Eurocode 8 Part 3. Guidance is given for different materials, including unreinforced masonry. There is no extensive guidance on structural upgrading measures for unreinforced masonry buildings. For the different countries of the European Union, this guidance is found in the National Annexes. This guidance is specific for local building stock and expected local ground shaking.

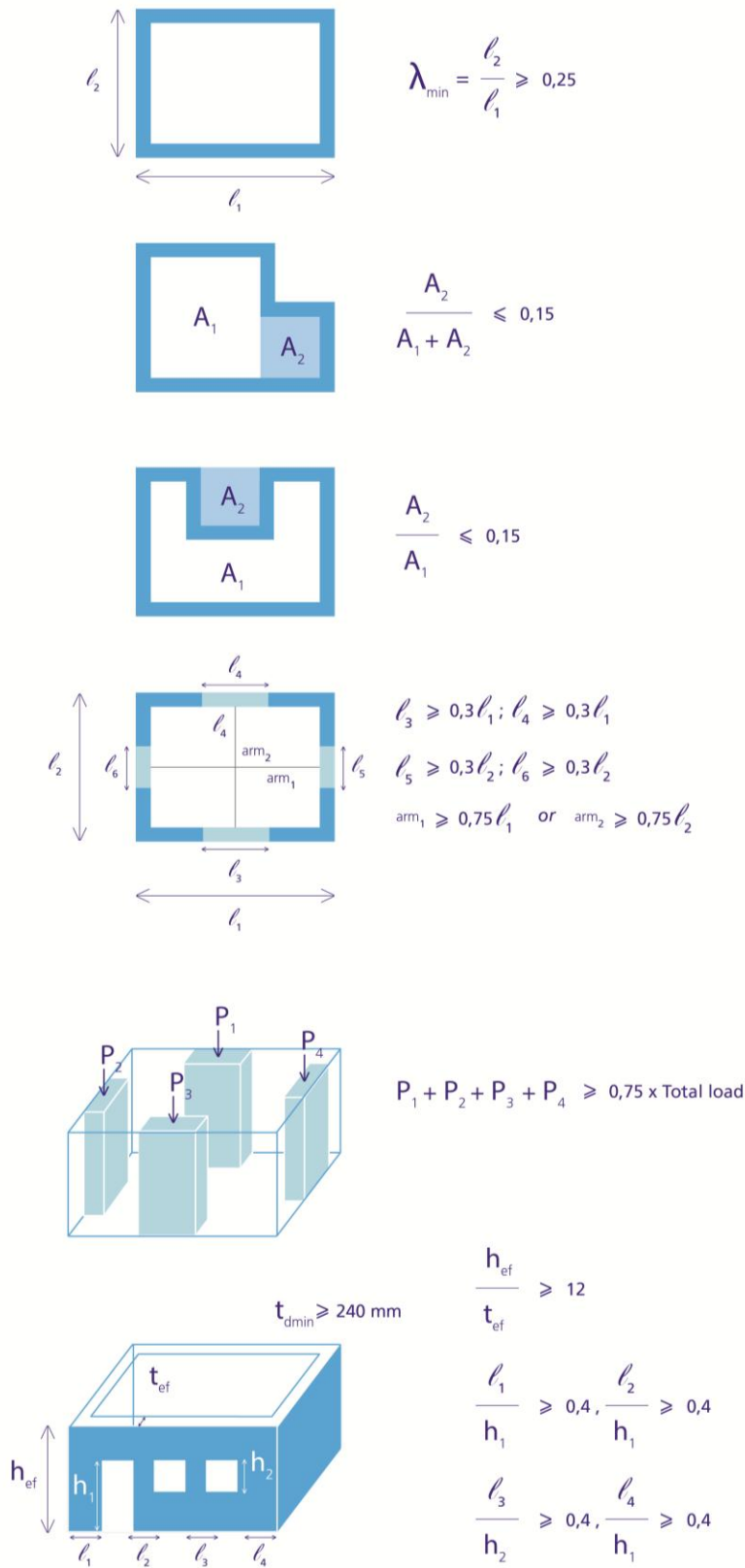

Figure 3 Simple building criteria according to Eurocode 8.

2.1.3.2 New Zealand Society for Earthquake Engineering (NZSEE)

The NZSEE document entitled “The Assessment and Improvement of the Structural Performance of Buildings in Earthquakes^[10]” gives detailed guidance on the assessment of existing masonry structures. In addition it suggests potential measures for structural upgrading, but does not give guidance on the design of these structural upgrading measures.

Figure 4 shows the process of the NZSEE procedure by the Technical Assessor (TA).

Seismic assessment is performed in two steps:

- **initial evaluation:** a simple procedure to evaluate capacity in relation to the capacity of a new building; and
- **detailed evaluation:** comprehensive evaluation.

2.1.3.3 American Society of Civil Engineers (ASCE)

ASCE 41-13 Seismic Evaluation and Retrofit of Existing Buildings is currently in draft and expected to be released early in 2014. It represents the state-of-the-art of engineering knowledge in the assessment of URM structures under seismic action. ASCE 41-13 combines the previous standards, ASCE 31-03 Seismic Evaluation of Existing Buildings^[11] and ASCE 41-06 Seismic Rehabilitation of Existing Buildings^[12].

ASCE 41-13 gives guidance for detailed assessment of existing buildings and covers unreinforced masonry in detail. ASCE 41-13 evaluates capacity on a component by component basis, allowing different ductility factors to be adopted for different failure modes.

Seismic assessment is performed in three levels:

- **Tier 1:** Screening of deficiencies in the resistance to seismic action;
- **Tier 2:** Deficiency based evaluation; and
- **Tier 3:** Systematic evaluation.

Figure 5 shows the process of the ASCE 41-13 procedure.

Figure 5 describes the process of this three-tiered approach according to the seismic evaluation and retrofit for existing buildings. The outcome from Tier 1 determines whether the evaluation ends there or proceeds to Tier 2 and Tier 3.

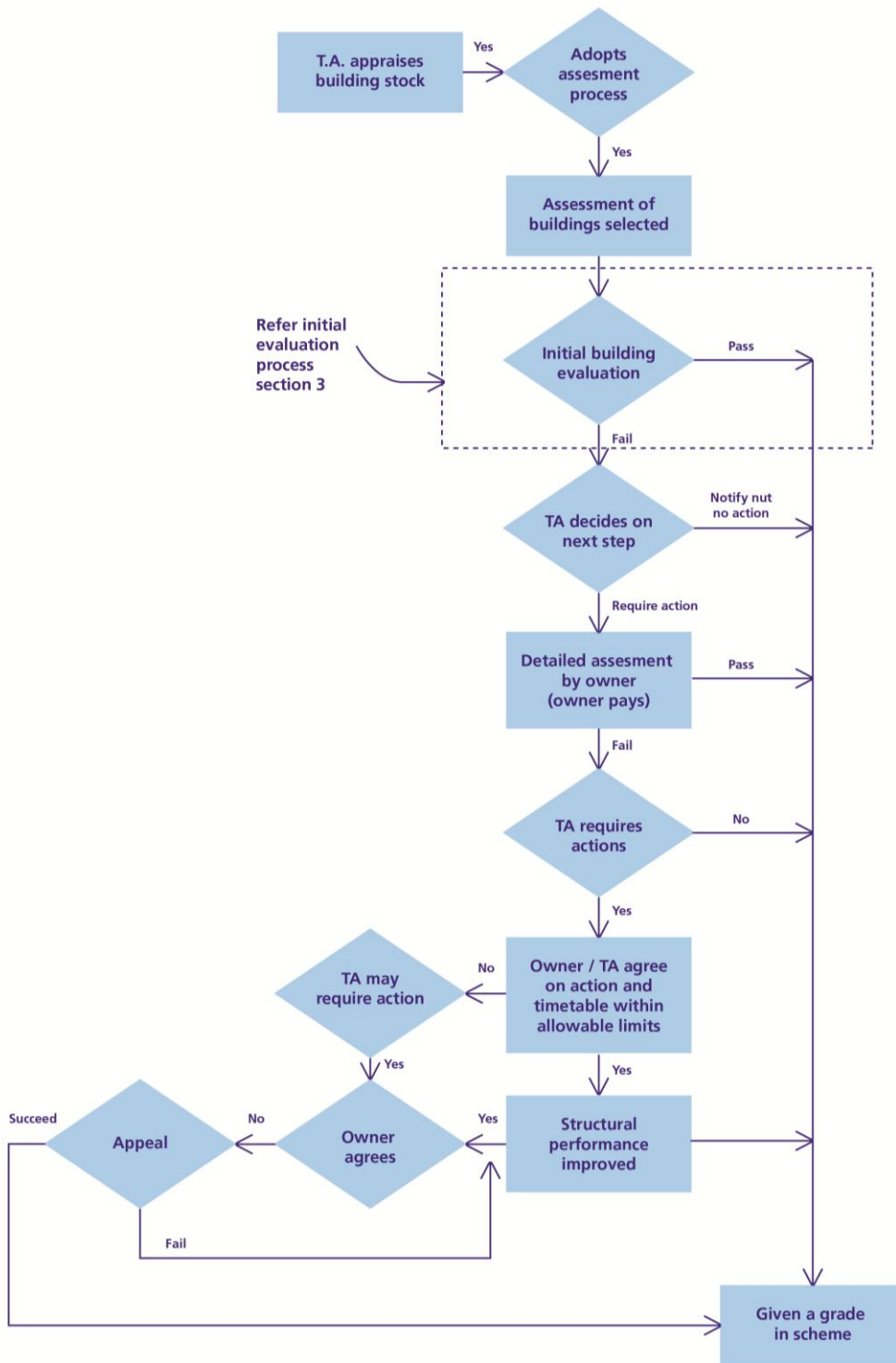

Figure 4 NZSEE Evaluation Process

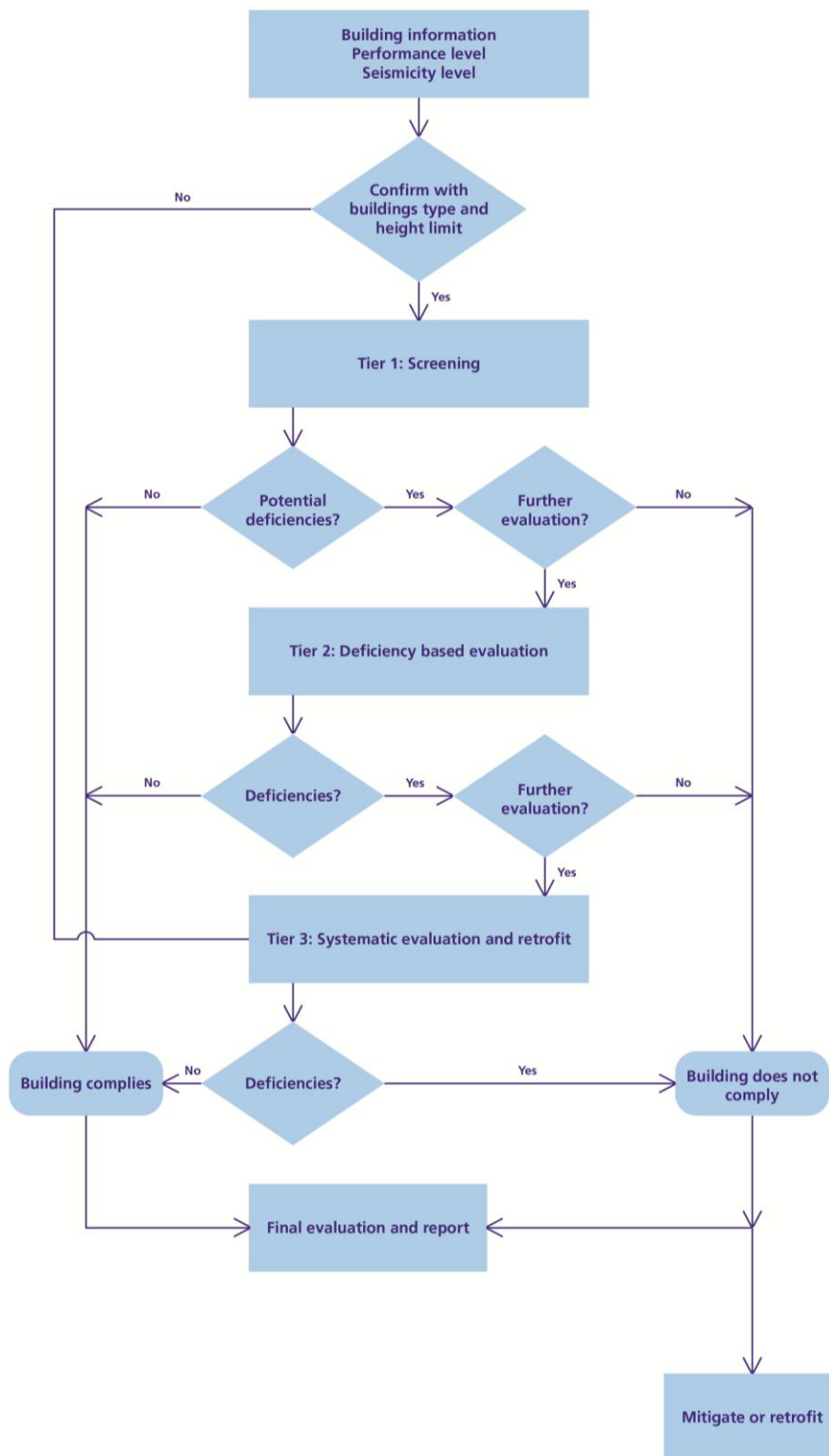

Figure 5 ASCE 41-13 Evaluation Process.

2.1.4 Selected design methodology

The basic design methodology is to use Eurocode 8 as much as possible and complement this with codified knowledge on the assessment of existing masonry buildings and the design of structural upgrading measures.

Eurocode 8 and ASCE 41-13 are compatible and have similar concepts:

- Both introduce ductility with a specific factor. Eurocode 8 introduces the q-factor that is set for materials and structural typology. ASCE 41-13 offers the m-factor that is set on element level and distinguishes failure mode with brittle and ductile behaviour, a concept that is powerful for existing buildings as it is not possible to select a favourable ductile failure mode and prohibit other modes; and
- Both use peak elastic response of linear single degree-of-freedom modes with 5% viscous damping. The actual shape of the spectrum is slightly different in Eurocode 8 than ASCE 41-13.

The Eurocode 8 response spectrum was used for the definition of the seismic action. This spectrum (see Section 2.4.1.1) is anchored on the local value of PGA which is available from the seismic hazard studies conducted for the region (see Section 2.2.3), and is available in EC8 for low magnitude earthquakes. The ASCE 41-13 spectrum requires two values of spectral acceleration (0.2 seconds and 1.0 seconds) which are currently not available for the region.

For the assessment of seismic resistance of existing masonry buildings, ASCE 41-13 was selected, which offers detailed procedures for assessment of existing masonry buildings and assessment methods for structurally upgraded buildings. The ASCE 41-13 integrates international knowledge on this subject, and is the most up to date reference available. Another American document, FEMA 547, provides guidance on the selection of retrofit techniques and ASCE 41-13 provides outline design guidance on quantification. Eurocode 8 does not consider all of the failure mechanisms that may occur in masonry buildings and does not offer guidance on the actual design of structural upgrading measures for masonry buildings.

For buildings with pre-existing damage, prior to a detailed assessment, a condition assessment based on post-earthquake safety assessments (ATC-20) is performed. Existing damage is also assessed to understand the causes of the damage. Finally, seismic evaluation is also carried out in a Tier 1 assessment approach using ASCE 41-13 checklists. The objective of seismic evaluation is to identify any seismic deficiencies in the structure, and to develop strengthening concepts to address each of these deficiencies. These assessments are outlined in Section 2.3.1.

2.2 Performance Requirements

2.2.1 New buildings

For new buildings, EC8 defines two performance requirements:

The seismic actions for these two requirements are given as a probability of exceedance for a reference period and the associated return period (assuming time-independent hazard):

1. **No Collapse requirement:** no local or global collapse, retaining structural integrity and residual load-bearing capacity after a seismic events.
 - a. Exceedance of 10% in 50 years; and
 - b. Return period of 475 years.
2. **Damage Limitation requirement:** no damage with associated repair cost that is disproportional to the value of the structure itself
 - a. Exceedance of 10% in 10 years; and
 - b. Return period of 95 years.

Other codes and standards also support this precedent.

2.2.2 Existing buildings

For existing buildings, the fundamental requirements refer to the damage of the structure defined through three limit states:

1. **Near Collapse:** the structure is heavily damaged, with low residual lateral strength and stiffness, although vertical elements are still capable of sustaining vertical loads. The structure is near collapse and would probably not survive another earthquake, even of moderate intensity;
2. **Significant Damage:** the structure is significantly damaged, with some residual lateral strength and stiffness. The structure can sustain aftershocks of moderate intensity and is likely to be uneconomic to repair; and
3. **Damage Limitation:** the structure is only lightly damaged, with structural elements retaining their strength and stiffness properties. The structure does not need any structural repair measures, but may benefit from cosmetic repair if required.

The seismic actions for these three requirements are based on a probability of exceedance for a reference period and the associated return period:

1. **Near Collapse** limit state:
 - a. exceedance of 2% in 50 years;
 - b. return period of 2475 years;
2. **Significant Damage** limit state:
 - a. exceedance of 10% in 50 years;
 - b. return period of 475 years;

3. **Damage Limitation** limit state:

- a. exceedance of 20% in 50 years;
- b. return period of 225 years.

For the purposes of this study, the Significant Damage limit state has been adopted for buildings generally (equivalent to 'Life Safety' performance objective in ASCE 41-13), with the Damage Limitation state for the utility buildings as these must remain operational after the design event (equivalent to 'Immediate Occupancy' performance objective in ASCE 41-13).

Figure 6 gives a comparison of performance requirements according to ASCE 41-13 and EC8 together with the associated damage states according to EMS.

Table 2 Approximate Mapping of Performance Requirements

Improved Performance (Less Damage)	ASCE (41-13)	EC8-1 (New Buildings)	EC8-3 (Existing Buildings)	Damage State EMS-98
	Operational (OP)	Damage Limitation		DS0 (no damage)
	Immediate Occupancy (IO)		Damage Limitation	DS1 (Negligible to slight)
	Damage Control (DC)			DS2 (Moderate) / DS3 (Substantial to heavy)
	Life Safety (LS)	No Collapse	Significant Damage	DS4 (Very heavy)
	Collapse Prevention(CP)		Near Collapse	DS5 (Destruction)

2.2.3 Seismic hazard

The seismic hazard distribution used in the study is acquired from the probabilistic seismic hazard analysis (PSHA) conducted by Shell P&T. Maps were developed for the level of peak ground acceleration (PGA) and peak ground velocity (PGV) associated with a 2%, 10% and 50% probability of exceedance in the next 10 years. The 2% probability is approximately equivalent to the design basis earthquake ground motion in Eurocode 8, which is for a 10% probability of exceedance in 50 years (return period of 475 years), see Figure 6. The PGA map is applied in the Structural Upgrading Study, as it is most directly related to design requirements in Eurocode 8 (the map might be subject to changes).

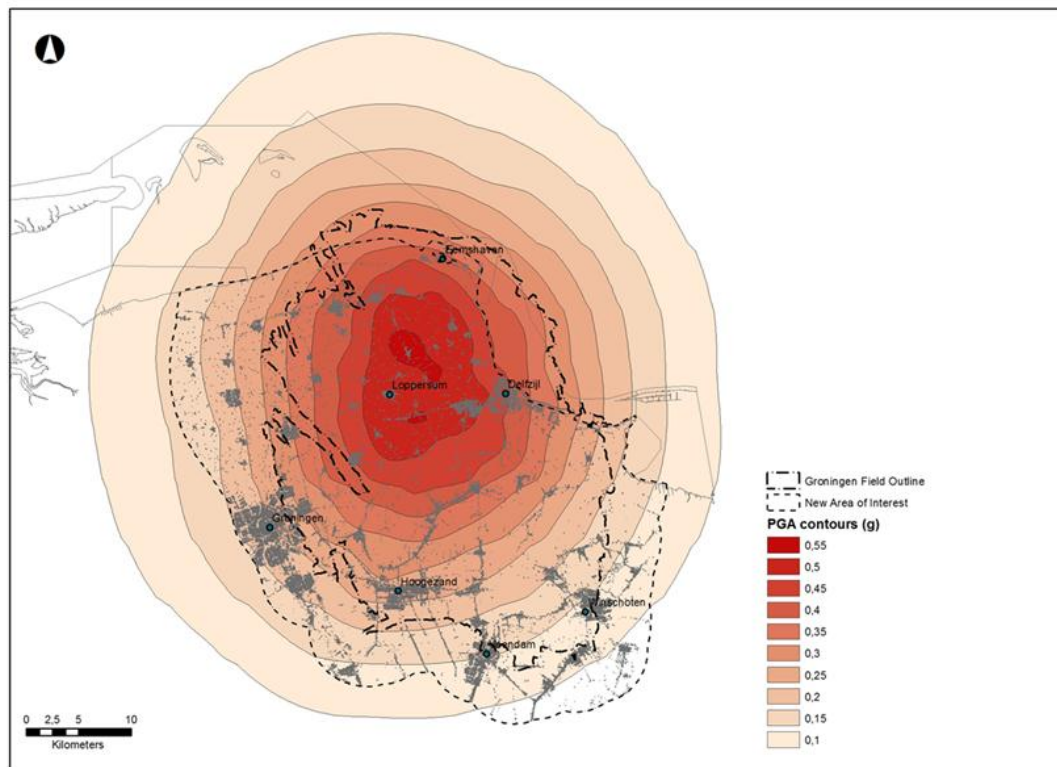

Figure 6 Seismic hazard (PGA contours) with a 2% probability of exceedance over the 2013-2023 period

The latest hazard map became available towards the end of this study. However the structural upgrading assessments in this report have been undertaken for PGA values of 0.25g. Based on a number of assumptions however, their range of applicability may be extended to areas of the hazard map with lower or higher PGA values. This is discussed further in Section 4.

2.2.4 Building importance

In Eurocode 8, importance classes are defined for buildings depending on their importance to public safety. Each class has a different importance factor associated with it which multiplies the peak ground acceleration to target improved seismic performance. The recommended values are as shown in Table 3.

Table 3 Importance classes according to Eurocode 8.

Importance class EC8	Importance factor EC8	Definition	Included buildings
IV	1.4	Buildings whose integrity during earthquakes is of vital importance for civil protection.	Fire stations, police stations, ambulance posts, hospitals, power plants.
III	1.2	Buildings whose seismic resistance is of importance in view of the consequences associated with a collapse.	Buildings recognized in the Nationale risicokaart (e.g. schools, day care centres, assembly halls, cultural institutions, large restaurants)
II	1.0	Ordinary buildings, not belonging in the other categories.	BAG* premises with addresses that are not part of EC8 categories III and IV (e.g. dwellings).
I	0.8	Buildings of minor importance for public safety.	BAG* premises without addresses (e.g. agricultural buildings, barns and garden sheds).

*Basisregistratie Adressen en Gebouwen

ASCE 41-13 allows a more direct measure of building importance to be taken into account. Instead of multiplying the seismic action by a constant factor, improved performance is targeted explicitly by comparing seismic performance against more onerous performance criteria. It is common to target an Immediate Occupancy (IO) performance level for important buildings such as schools and hospitals, which effectively means that no structural damage can occur. This effectively fulfils the same objective as the use of importance factors, but may not be numerically equivalent.

In this study, a mix of approaches has been selected. For typical buildings (importance class II), an importance factor of 1.0 was used (i.e. seismic actions were not adjusted). For the school building (importance class III), an importance factor of 1.2 was used. For the utility building (importance class IV), immediate occupancy performance was targeted directly in the absence of relevant guidance in EC8 (i.e. ASCE 41-13 approach). Finally, for barns (importance class I) an importance factor of 0.8 could have been used, but 1.0 has been used in the work done to date.

2.2.5 Upgrading objective

Eurocode 8 allows for the adoption of lower loads for existing buildings compared to those for new buildings. Section 2.1 of Eurocode 8, Part 3 sets out 3 limit state checks and allows National Authorities to determine whether 1, 2 or all 3 are to be used. The appropriate levels of protection are defined by the prescription of return periods for each of the limit states. The return periods of the seismic hazard to be adopted in the structural analysis for the Groningen region are currently under development. This effectively allows scope to design upgrading measures for an existing building for less than 100% of the equivalent new building strength.

In the NZSEE guidelines, existing buildings have to be structurally upgraded under law when the capacity is less than 33% of the capacity of a new building. Between 34%-66% upgrading is advised, while a capacity of at least 67% is deemed acceptable. However, NZSEE recommends that all existing buildings should be upgraded to at least 67%, while 100% is recommended as desirable. The upgrading objective and upgrade criteria for the NZSEE guidelines are shown in Figure 7. ASCE 41-13 also allows lower performance criteria for existing structures, which result in loads that are about 75% of those for new structures.

CAPACITY OF EXISTING BUILDING
(AS % OF NEW BUILDING)

Figure 7 Upgrading objective and criteria (NZSEE)

2.3 Seismic Evaluation

A number of levels of seismic assessment and evaluation are considered in this study.

For damaged buildings, an initial safety assessment was conducted to ATC-20 (see Section 2.3.1.1 below), which is used in post-earthquake situations to assess whether buildings are safe to access. A condition assessment was also carried out to help to indicate causes of observed damage. Finally, a Tier 1 assessment to ASCE 41-13, based on checklists to identify seismic deficiencies, was carried out.

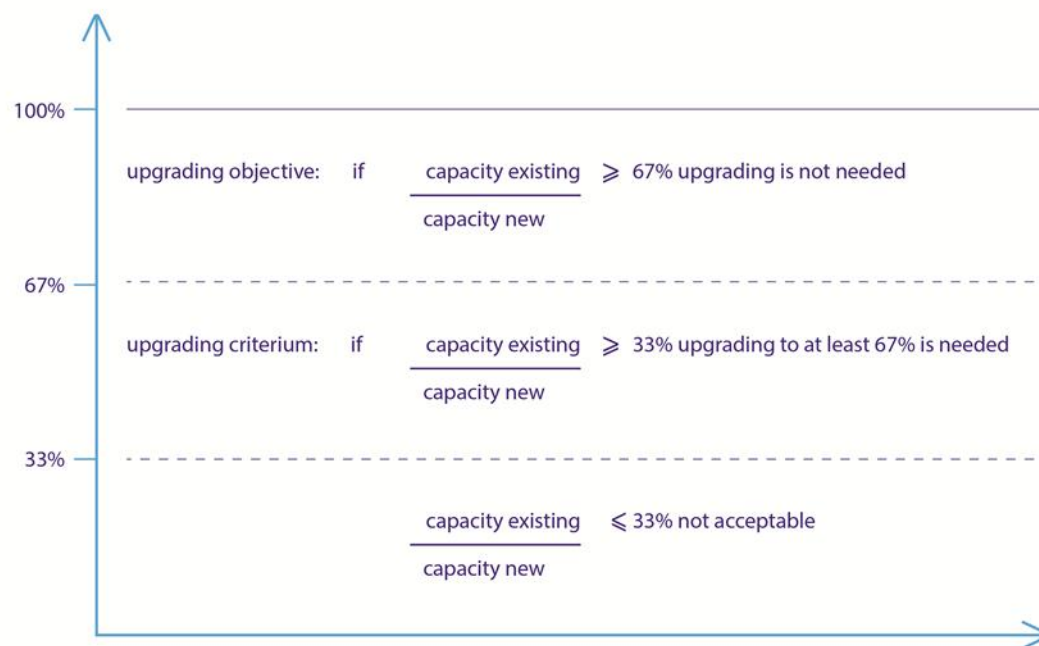
ASCE 41-13 also considers two more detailed tiers of assessment – Tier 2 and Tier 3 assessments. Tier 3 assessments were carried out on all studied buildings.

The full assessment procedure and the various steps in the process are discussed in the following subsections.

2.3.1 Damaged buildings

2.3.1.1 Safety assessment according to ATC 20

The ATC-20 safety survey typically assesses damage due to earthquakes and has the objective to return people into safe homes, and to keep people out of unsafe structures. This survey was originally intended for post-earthquake safety assessment (i.e. assessing earthquake-caused damage), but serves a useful purpose as part of this study to assess current building safety.

The ATC-20 is intended to be rapid and uses green, yellow and red tags to indicate the safety level:

- **Green** (inspected and ‘safe’): safety has not been significantly changed compared to undamaged state;
- **Red** (unsafe): threat of live safety for entry or occupancy in all or most of the structure;
- **Yellow** (restricted use): some risk from damage in all or part of the building. Entry, occupancy, and lawful use are restricted in accordance with the area, occupancy duration, or other restrictions.

For most cases red will result in the building being demolished. If the aim for the building is to be structurally upgraded and is tagged red or yellow, an assessment is required to determine whether there is a need to provide shoring, propping or strapping to safeguard the building from collapsing until it is upgraded.

2.3.1.2 Damage assessment

Damage Criteria ASCE 41-13

The damage of the unreinforced masonry walls has been assessed to a Life Safety (LS) performance level as defined in the ASCE 41-13, see Figure 6. This is considered as part of the Tier 1 screening discussed in Section 2.3.2.1.

For unreinforced masonry walls, the ASCE 41-13 uses the following criteria for both crack width and crack pattern for the Life Safety performance level:

- **Structural walls:** there shall be no existing diagonal cracks in the wall elements greater than 3 mm or out-of-plane offsets in the bed joints greater than 3 mm and shall not form an X pattern
- **Non-structural (infill) walls:** there shall be no existing diagonal cracks in the wall elements greater than 3mm or out-of-plane offsets in the bed joints greater than 3 mm

Damage Patterns and Damage Level

To understand the relationship between damage patterns; causes of damage and levels of damage two reports were used:

- Structural damage in masonry: Developing diagnostic decision support^[7]; and
- Structural damage in masonry: Prototype of a diagnostic decision support tool^[8]

These reports describe a diagnostic approach to assess damage by providing an organised overview of how damage to masonry in the Netherlands can occur and in what way they can be distinguished visually.

The first report deals with the diagnosis of structural damage in traditional masonry: cracks, deformations and tilts. Establishing the cause of this type of damage can be difficult. This report aimed to improve and facilitate the diagnostic process by offering support in the initial phase in which hypotheses are generated. The more precise hypotheses are formulated and the more accurately they are classified, the more effective the further process of verification will be and the greater the probability that the final diagnosis is correct. This has resulted in a diagnostic decision support tool that helps surveyors to distinguish between causes by offering support in interpreting structural damage in masonry.

The prototype of a diagnostic decision support tool for structural damage in traditional masonry is the result of a PhD research project^[8]. Based on an extensive literature review of 500 cases of structural damage, 60 characteristic damage patterns have been identified. For

each of these damage patterns, possible causes have been listed. A decision tree helps users determine which of the 60 damage patterns most closely matches the damage they are investigating.

The recorded degree levels 0-5 is a commonly classified system in the Netherlands based on damage levels (see Table 4) expressed in terms of ease of repair and typical crack width, as Eurocode does not provide these damage level criteria. It should be noted that those levels 0-5 are not the same as the DS1-DS5 as indicated in Figure 6 damage scale used in other reports. The above reports refer to the same damage levels. The ASCE 41-13 refers to a crack width greater than 3 mm; this is equivalent to degree level 3, 4 and 5. Therefore, degree levels 0, 1 and 2 are compliant with Life Safety criteria, and degree levels 3, 4 and 5 are non-compliant (see Table 4).

The severity of visible damage in walls for typical causes of damage in the Netherlands is commonly classified with a system based on the damage level, expressed in terms of ease of repair and typical crack width in which the six degrees of damage are defined as follows:

Table 4 Structural Damage in Masonry – Degree Levels

Degree 0	Negligible. Hairline cracks less than about 0.1mm;
Degree 1	Very slight. Fine cracks which are easily treated during normal decorating. Damage generally restricted to internal wall finishes. Close inspection may reveal some cracks in external brickwork or masonry. Typical crack widths up to 1mm;
Degree 2	Slight. Cracks easily filled. Redecoration probably required. Recurrent cracks can be masked using suitable linings. Cracks may be visible externally and some repointing may be required to ensure weather tightness. Doors and windows may stick slightly. Typical crack widths up to 5mm;
Degree 3	Moderate. The cracks require some opening up and can be patched by a mason. Repointing of external brickwork and possibly a small amount of brickwork to be replaced. Doors and windows sticking. Service pipes may fracture. Weather tightness often impaired. Typical crack widths are 5 to 15mm or there are several greater than 3mm
Degree 4	Severe. Extensive repair work involving breaking-out and replacing sections of walls, especially doors and windows. Windows and doorframes distorted, floor sloping noticeably. Walls leaning or bulging noticeably, some loss of bearing in beams. Service pipes disrupted. Typical crack widths are 15 to 25mm, but also depend on the number of cracks; and
Degree 5	Very severe. This requires a major repair job involving partial or complete rebuilding. Beams lose bearing, walls lean badly and require shoring. Windows broken with distortion. Danger of instability. Typical crack widths are greater than 25mm, but depend on the number of cracks.

2.3.2 Seismic evaluation

Seismic evaluation was based on ASCE 41-13

2.3.2.1 Tier 1 Screening

The screening procedure was set up to quickly identify potential deficiencies by using checklists for building components.

These building components are:

- Structural;
- Non-structural; and
- Geological site hazards and foundations.

Tier 1 is permitted for Immediate Occupancy, Damage Control or Life Safety performance levels (see Table 2). There are other limits on the use of the Tier 1 procedure based on structural type, level of seismicity and height. For example, for unreinforced masonry buildings in a high seismicity area the height limit is four storeys for both Immediate Occupancy and Life Safety performance levels. Above four storeys, Tier 3 is required.

As a result of the screening, these deficiencies can either be rehabilitated (retrofitted) or further Tier 2 or 3 evaluation is required.

2.3.2.2 Tier 2 Deficiency-based evaluation

Tier 2 is permitted for Immediate Occupancy, Damage Control or Life Safety performance levels. There are other limits on the use of the Tier 2 procedure based on structural type, level of seismicity and height.

Tier 2 is considered appropriate for small, relatively simple buildings for which the common deficiencies are well understood.

Tier 2 focuses on assessing and strengthening only those deficiencies that were identified in Tier 1.

- **Condition assessment:** Evaluate deterioration or damage identified in Tier 1. Extent and consequence of deterioration or damage to lateral force-resisting system based on the judgment of the evaluator;
- **Analysis methods:** Analysis of lateral-force resisting system based on linear static procedure (LSP) or linear dynamic procedure (LDP), such as the Response Spectrum Method.

2.3.2.3 Tier 3 Systematic evaluation and retrofit

Tier 3 is a complete assessment of the seismic response of the building, either in its current condition or with proposed retrofit measures.

Permitted analysis methods are the same as for the Tier 2 evaluation. In addition, a nonlinear dynamic procedure (NDP) can be used.

To use nonlinear analysis a 'usual' or 'comprehensive' level of knowledge is required. This requires, as a minimum, either material test records from the original design or as-built material test data.

2.3.2.4 Followed process

Due to the number of deficiencies and the complexity identified for the buildings, the assessment proceeded directly to Tier 3 after Tier 1.

2.4 Components of Seismic Evaluation

2.4.1 Seismic action

2.4.1.1 Elastic response spectrum

In Eurocode 8, seismic motion of the surface is represented by an elastic response spectrum. This response spectrum gives the peak structural acceleration as function of the natural period of the building.

The response spectrum used (as illustrated by the solid black line in Figure 8) is described by:

- The design response spectrum according to EN 1998-1, section 3.2.2.5;
- Spectrum Type 2 (Earthquake Magnitude < 5.5);
- Ground Type E (Soil Factor = 1.6);
- Periods (TB, TC and TD) according to EN 1998-1, table 3.3; and
- Viscous damping ratio 5%.

This response spectrum gives a reasonable comparison with response spectral shapes based on the ground acceleration curves of Akkar et al. (2013) for $M = 4$ to 5.5, hypocentral distance = 3 km and $V_{s30} = 150$ to 300 m/s as shown by the coloured lines in Figure 8, normalised with respect to surface PGA. The Akkar et al. (2013) prediction equation has not been specifically verified for the Groningen region for longer-period structural response, and therefore the extra conservatism introduced at longer periods by using the Eurocode 8 spectrum is justified until further studies have been carried out.

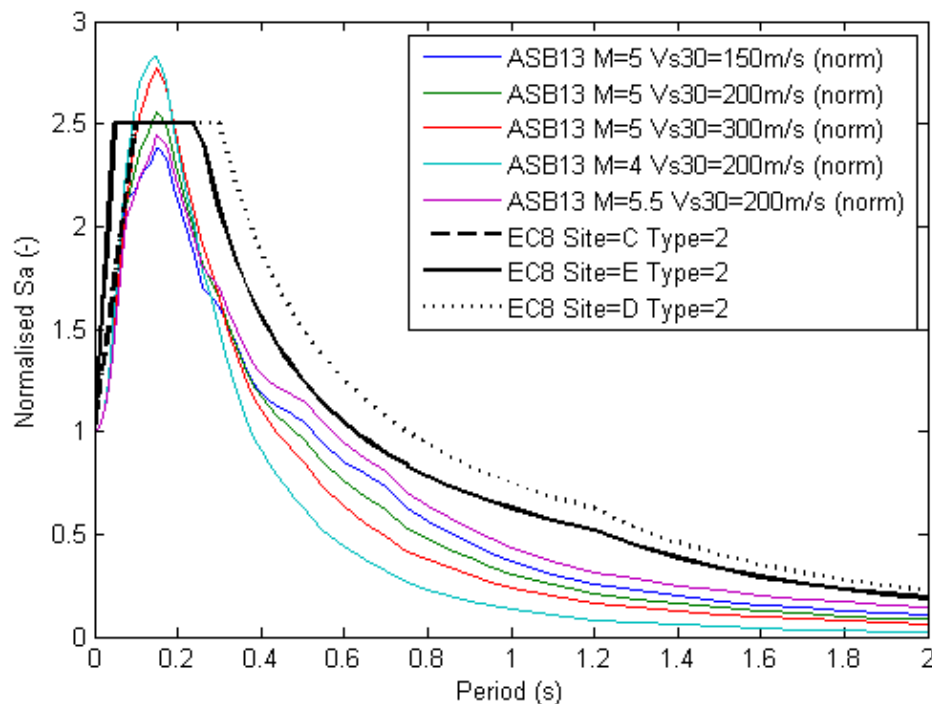

Figure 8 Expected spectrum vs Eurocode normalised to surface acceleration

2.4.1.2 Ground motion time-histories

For non-linear time-history analysis, the seismic action must be given in terms of ground acceleration versus time. This ground motion time history should be consistent with the response spectrum definition shown in Figure 8. Eurocode 8 and ASCE 41-13 contain requirements for the development of ground motion time histories, to ensure that they are consistent with the spectrum and contain appropriate characteristics (such as duration) that may affect structural response estimates.

For the time history analyses conducted as part of this work, ground motions were developed by selecting recordings of real magnitude 4.5 to 5.5 earthquakes from Japan, Italy and the United States. The records were selected to have an appropriate duration for the scenario earthquake considered. Each record contained three components (two horizontal and one vertical). The ground motions were modified using a computer program, RspMatch2005, which makes small adjustments to the acceleration to ensure a close match to the target spectrum.

Two suites of three ground motions were developed:

1. Based on the shorter durations expected of a M4.5 to M5 earthquake; and
2. Based on longer durations expected of a M7 earthquake.

The latter was used for comparison to explicitly measure the effect of ground motion duration on structural response.

2.4.2 Seismic resistance

2.4.2.1 Ductility and behaviour factor

Codes and guidelines for seismic design and assessment typically allow the engineer to take into account non-linear response of materials and structures. This means that structures will be deformed plastically following a design earthquake although will not collapse and endanger the occupants.

For linear analysis methods (static or dynamic), this non-linear response is taken into account with a behaviour or ductility factor, which is given for different materials and structural systems. Non-linearity is taken into account differently in Eurocode 8 and ASCE 41-13. In Eurocode 8, all the seismic design forces are divided by a factor, q , which is recommended to be taken as 1.5 for masonry structures that have not been detailed to the requirements of Eurocode 8. Corresponding factors for steel and reinforced concrete structures are greater than 4, which demonstrate the benefits of using more ductile materials and structural configurations.

ASCE 41-13 instead applies the behaviour factor, m , as a multiplier to the capacity (i.e. seismic resistance is increased rather than seismic action decreased). This is done on a component-by-component basis (i.e. in this case each wall pier can have a different m factor), rather than all the capacities being increased by the same number. It distinguishes between force-controlled and deformation-controlled actions, corresponding to brittle and ductile failure modes respectively. If all the piers in a wall fail in a ductile manner, a ductility factor, m , can be taken into account. The m -factor depends on the performance level, member type and rocking or bed joint sliding. The m -factors are limited and depend on the pier shape for rocking. Values for the life safety performance level vary between 1.5 and 3.75 for deformation-controlled actions.

For nonlinear analysis methods (static or dynamic), non-linear response is calculated explicitly, and therefore forces do not need to be adjusted to account for ductility. ASCE 41-13 tabulates allowable non-linear deformations for different types of structural component, depending on the same parameters as discussed above for linear analysis. These are given for different performance criteria, so more onerous performance objectives (such as Immediate Occupancy) restrict the amount of non-linearity that can be taken into account.

2.4.2.2 Wall in-plane capacity

In ASCE 41-13, the masonry walls with openings for windows and doors are assumed to behave as a series of piers in between openings (see Figure 9).

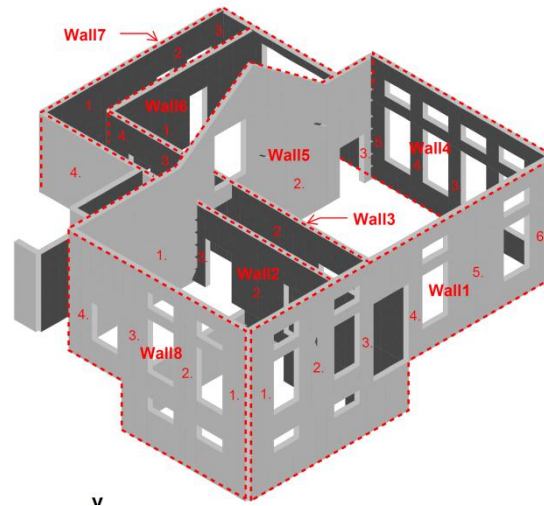

Figure 9 Pier behaviour of masonry walls with openings.

ASCE 41-13 checks are based around this assumption – each pier is checked individually for its in-plane capacity on the basis of the following possible failure mechanisms (see Figure 10).

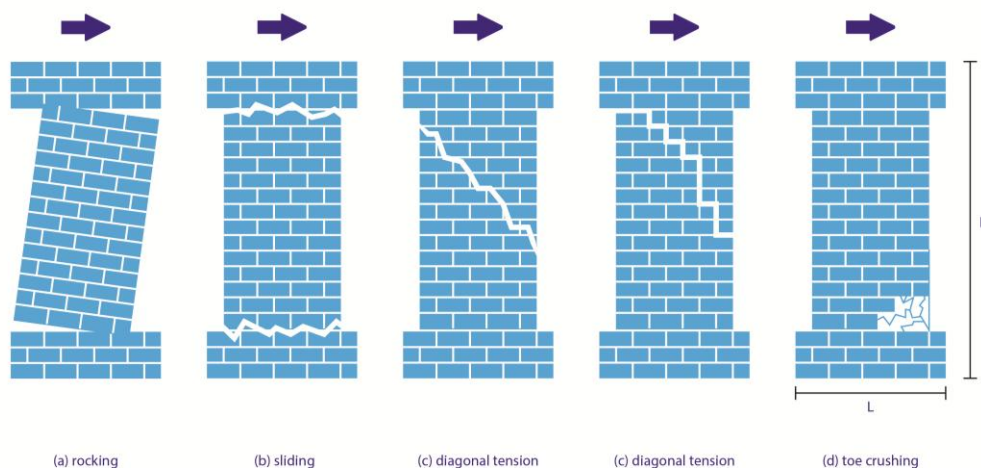

Figure 10 Pier failure modes.

- a) **Rocking:** mortar joints opening up at top and bottom of the pier, and the pier is rocking on its base;
- b) **Bed joint sliding:** sliding of all or a portion of the pier along mortar bed joints;
- c) **Diagonal tension cracking:** Shear failure in the pier leading to diagonal tension cracking;
- d) **Toe crushing:** the masonry crushing at the toe of the rocking wall;

The rocking and bed joint sliding failure mechanisms are considered deformation-controlled. Toe crushing and diagonal tension are brittle failures and can occur suddenly and without warning. Piers governed by deformation-controlled actions are preferred, as they remain stable under large deformation and dissipate earthquake energy, exhibiting ductile behaviour.

Figure 11 illustrates seismic/shear failure as a function of pier aspect ratio (i.e. height: width ratio) and axial stress. This figure shows that the failure modes are governed by the following parameters:

- **Rocking:** lower aspect ratio, lower vertical stress;
- **Bed joint sliding:** higher aspect ratios, lower vertical stress;
- **Diagonal tension:** lower aspect ratios, higher vertical stress; and
- **Toe crushing:** higher aspect ratio, higher vertical stress.

Accordingly, low rise buildings are most likely to be governed by rocking or bed joint sliding failure modes, as they will most likely encounter low vertical stresses in the wall piers.

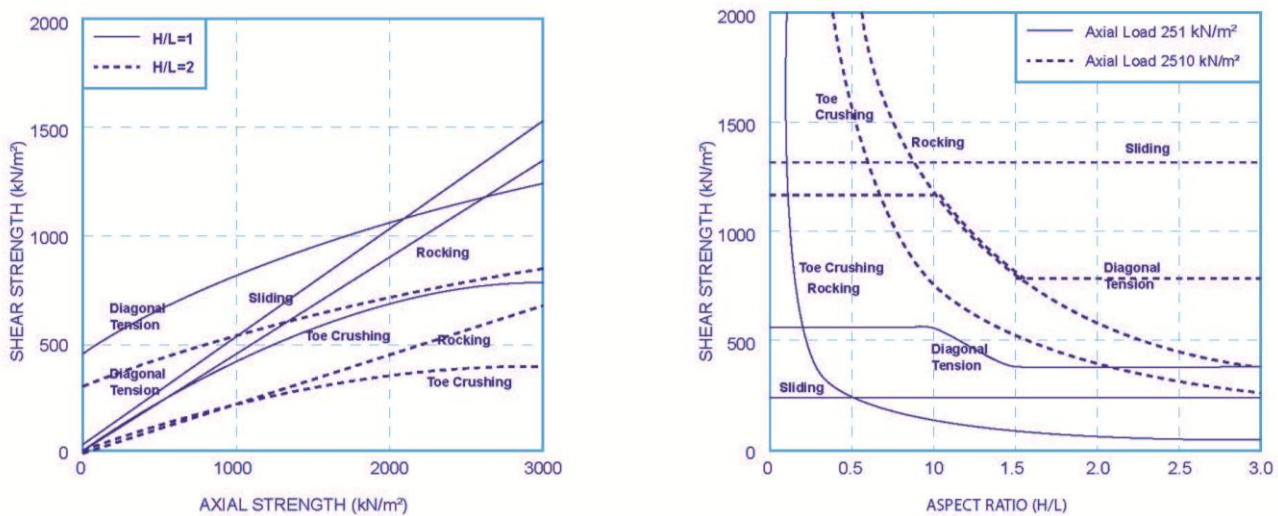

Axial strength and shear stress relationship

Aspect ratio and shear stress relationship

Figure 11 Shear strength as a function of axial stress and failure modes

2.4.2.3 Wall out-of-plane capacity

Out-of-plane capacity of unreinforced masonry walls is affected by the boundary conditions of the walls. Significant improvement is provided when walls are adequately tied to the floors and roof.

ASCE 41-13 does not give guidance for out-of-plane capacity assessment. Instead it gives permissible slenderness ratios. Assuming that walls are sufficiently tied to the floors, ASCE 41-13 gives maximum slenderness ratios below which the walls are considered to be stable. Slenderness ratios are given as a function of wall type and are shown in Table 5. ASCE 41-13 compares this table against current recent research and advises on further research for a better understanding of influencing factors of out-of-plane failure.

In ASCE, cavity walls are dealt with by ignoring any contribution of the outer leaf to structural capacity.

Table 5 Out-of-plane capacity per wall type with respect to slenderness ratio (height/thickness)
 S_{XI} – acceleration of $T = 1$ s sec.

Wall Types	$S_{XI} \leq 0.24g$	$0.24g < S_{XI} \leq 0.37g$	$S_{XI} > 0.37g$
Walls of One-Storey Buildings	20	16	13
First-Storey Wall of Multi-storey Building	20	18	15
Walls in Top Storey of Multi-Storey Building	14	14	9
All Other Walls	20	16	13

Note that NZSEE offers more extensive guidance on the assessment of out-of-plane capacity. Further study is needed on the approach adopted and the basis on which this has been produced.

2.4.2.4 Knowledge factor, k

ASCE 41 uses a knowledge factor k to reduce capacities for cases where sufficient information is not available or sufficient testing has not been carried out to confirm material properties accurately. The knowledge factor varies between 0.75 and 1.0. The former factor has been adopted at this time. Tests are planned to justify an increase to 1.0.

2.4.3 Structural analysis

2.4.3.1 Analysis software

The linear-elastic analyses have been carried out using the program GSA developed by Oasys. This program is chosen because it can undertake modal response spectrum analysis to capture all key modes and has embedded post-processing routines.

Other analytical tools applied in the study are:

- LS-DYNA - for the non-linear dynamic building models and studies;
- SAP2000 – for the non-linear macro element push-over analyses; and
- Custom spreadsheets – for the mechanism-based non-linear approach.

2.4.3.2 Building model assumptions

Initial model assumptions involved the following simplifications:

- The boundary conditions at foundation level have been taken as pins, giving an upper-bound on foundation stiffness. This will produce an associated lower bound on period and upper bound on seismic force assuming the main responses are on the plateau of the response spectrum. This is a potentially conservative approach, which has been investigated in the preliminary Soil Structure Interaction (SSI) study summarised in Section 3.3.2
- Cavity walls, when present, have been modelled as solid walls. The modelling of cavity walls as solid walls provides an upper bound on stiffness to generate preliminary conservative analysis results for assessment. This has been investigated further and summarised in Section 0; and
- For buildings that behave like boxes (refer to Appendix A), two results are obtained for the analysis based on an assumption of the elements having adequate ties and adequately stiff diaphragms:
 - Connection forces for wall/floor, wall/roof and wall/wall connections;
 - Shear and normal forces on top of the pier.

For buildings that do not behave like boxes, due to large stiffness differentials, the stiff parts and flexible parts were modelled separately, while their interaction was taken into account in both models. Engineering judgement is made to estimate this interaction behaviour.

2.5 Analysis Methodology

In accordance with EC8, the seismic action effects may be evaluated using one of the following methods:

Table 6 Analysis Methodologies

1.	Lateral force analysis;	Linear Static Procedure
2.	Modal response spectrum analysis; a) 2D Shell elements b) Equivalent frame method	Linear Dynamic Procedure
3.	Non-linear static pushover analysis a) Macro elements and using equivalent frame method b) Mechanism-based elements	Non-linear Static Procedure
4.	Non-linear time-history analysis	Non-linear Dynamic Procedure

In the linear methods, the non-linear behaviour of the real structure is incorporated by applying the behaviour factor, q .

In general, moving from linear to non-linear analysis, and from static analysis to dynamic analysis increases the model pre- and post-processing time, and the computational effort involved.

Generally, codes are expected to be more conservative for the simpler analysis methods, compensating for the modelling uncertainty introduced by their use. As the modelling becomes more detailed, the mathematical representation of the actual structural behaviour increases in accuracy, resulting in less-conservative outcomes.

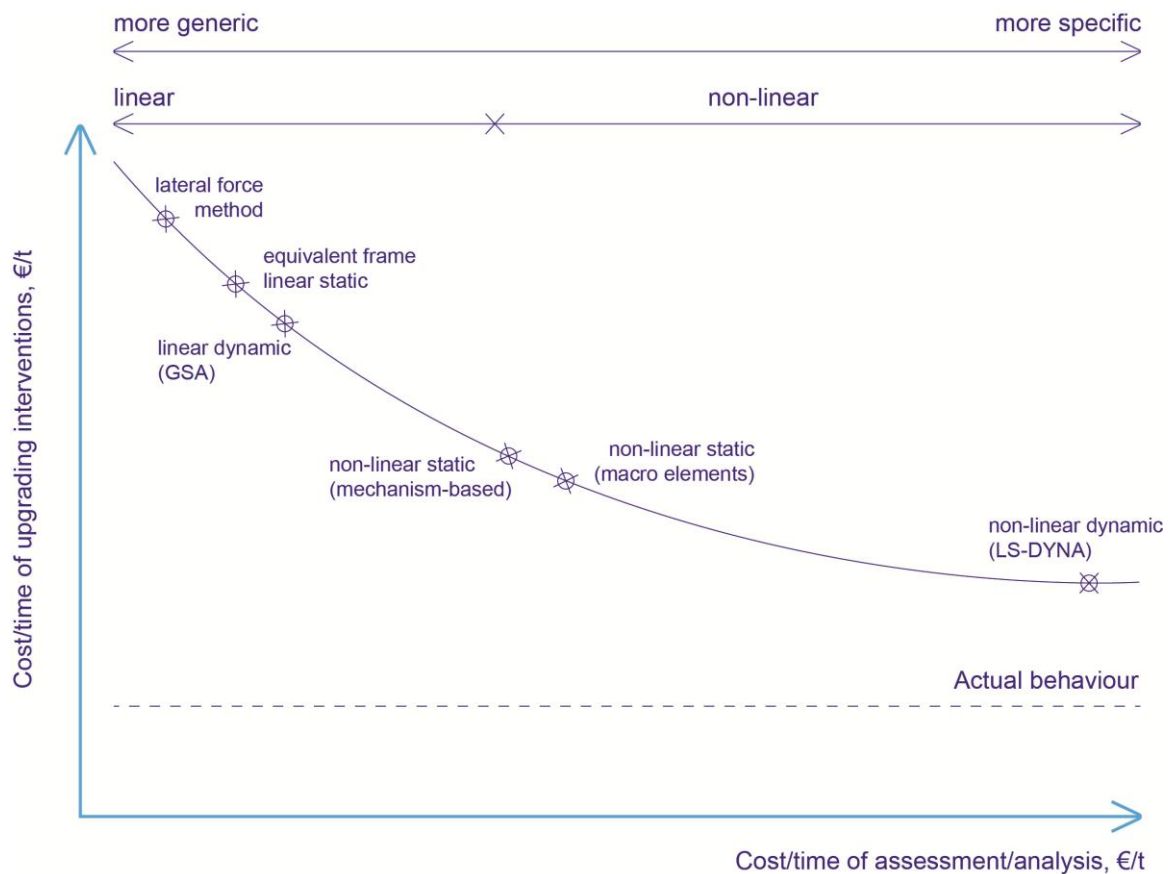

Figure 12 Qualitative comparison of alternative analysis methodologies.

For Pilot 1 Phase 1, a balance was sought between time and accuracy and the ease with which the methodology could be incorporated into a design guide and deployed on a large scale within the Dutch engineering community. The modal response spectrum analysis was therefore selected as the primary methodology. This is also the default methodology according to EC 8 (this was in the context of a maximum seismic hazard of PGA 0.1g at the time). As the seismic hazard was unknown and increasing with greater knowledge of subsurface conditions, the alternative methods have been investigated in parallel.

Table 7 summarises how key component of the seismic action and seismic resistance are considered in each method.

Table 7 Components of Seismic Action and Seismic Resistance

	Seismic Action	Seismic Resistance			
		Masonry in-plane strength	Masonry in-plane ductility	Masonry out-of-plane response	Knowledge
Lateral force analysis (Section 2.5.1) <i>Static</i>	Seismic forces based on response spectrum and empirical building period.	Capacity based on lower bound of potential failure mechanisms, using code equations.	Force-based mechanisms, no ductility allowance. Deformation-based mechanisms, multiply strength by m factor that depends on mechanism and wall aspect ratio.	Slenderness limits provided.	Multiply capacities by knowledge factor, κ .
Modal response spectrum analysis using equivalent frame elements (Section 2.5.2) <i>Dynamic</i>	Same as above.	Same as above.	Same as above.	Same as above.	Same as above.
Modal response spectrum analysis using 2D shell elements (Section 2.5.3) <i>Dynamic</i>	Same as above.	Same as above.	Same as above.	Same as above.	Same as above.
Non-linear static pushover analysis using macro elements (Section 2.5.4) <i>Static</i>	Seismic forces ramped up until target displacement reached; target displacement based on elastic response spectrum, building period and nonlinear response coefficients.	Same as above.	Force-based mechanisms, no ductility allowance. Deformation-based mechanisms, displacement limits provided based on mechanism and wall aspect ratio.	Same as above.	Same as above.
Non-linear static pushover analysis using mechanism-based elements (Section 2.5.5) <i>Static</i>	Displacement increments applied until load multiplier is zero. Target displacement obtained according to elastic response spectrum and structural period.	Collapse mechanism(s) selected <i>a priori</i> and total seismic resistance checked. Generally this method is not used for in plane checks, except for well-known mechanisms like those found in historic buildings.	The aim of the analysis is to check the ultimate displacement capacity and the damage limit state. Maximum displacement and force of mechanism are checked explicitly.	This is the main application of the analysis. The seismic performance of the structure is analysed up to collapse by increasing the displacement and applying the principle of virtual work to the corresponding configurations.	Multiply masonry strength by knowledge factor. Since masonry blocks are rigid, this strength just affects the position of “yield” lines.
Non-linear time-history analysis (Section 2.5.6) <i>Dynamic</i>	Ground accelerations consistent with the elastic response spectrum applied directly to the base of the model in the time domain.	Capacity based on explicit consideration of non-linear behaviour of bricks and mortar and development of cracking.	Allowable deformation based on explicit consideration of non-linear behaviour of bricks and instability.	Allowable deformation based on explicit consideration of non-linear behaviour of bricks and instability.	No knowledge factor currently considered; to use this method with confidence, material testing required, which removes need for knowledge factor.

2.5.1 Lateral force analysis

The lateral force analysis is appropriate where the seismic response is not significantly affected by contributions from modes of vibration higher than the fundamental mode. It is simple to use, quick to apply and straightforward to interpret results. It is therefore amenable for development into a design guide. It is limited to simple structures and geometries, however, and it is not possible to account for seismic duration effects.

2.5.2 Modal response spectrum analysis using 2D shell elements

This method is suitable for buildings where response is affected by contributions from modes of vibration higher than the fundamental mode. Modal response spectrum analysis breaks the overall dynamic response of the building into individual “modes” of response, which are different patterns of deformation that may be excited by base shaking. The actual observed response of a real structure is a combination of these modes, with some more dominant than others. See Figure 13 below.

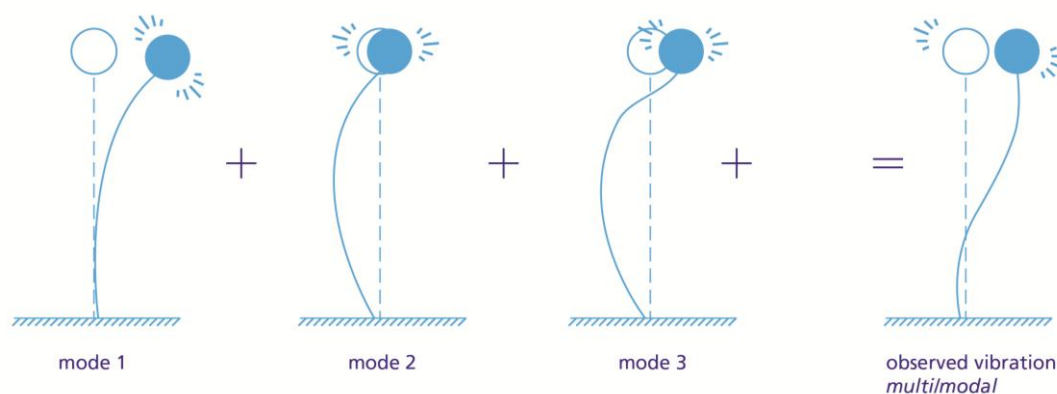

Figure 13 Modal response of Single Degree of Freedom (SDOF) Structures.

Each mode is associated with a particular vibration period – more flexible modes of response have longer periods whereas stiffer modes have shorter periods. Depending on the structure and the analysis model, anything from a few up to 100s of modes may be required to adequately describe the overall seismic response of the building.

For the modal response spectrum analysis, Eurocode 8, Part 1, section 4.3.3.3.1 states that one of the following must be demonstrated:

- The sum of the effective modal masses for the modes taken into account amounts to at least 90% of the total mass of the structure;
- All modes with effective modal masses greater than 5% of the total mass are taken into account.

Earthquake loads are represented by the response spectrum. A response spectrum gives the maximum value of acceleration in each mode as a function of its period. However, the peaks of all these modes of response do not occur simultaneously in the earthquake ground motion, and therefore a statistical combination rule is required to combine the results together to determine the expected peak values from an actual earthquake. The standard statistical

method used for combining these modal responses together is called the Complete Quadratic Combination (CQC) rule, and has been adopted for this project.

Ground shaking can occur in any direction. However, as with modal combination the peak response from, for example, X- direction shaking does not occur at the same time as that due to Y-direction shaking. Therefore, these are combined in Eurocode 8, Part 1 by taking the maximum of the following combinations:

- $\pm 100\% X \pm 30\% Y$
- $\pm 30\% X \pm 100\% Y$

The vertical component Z is not taken into account as allowed by Eurocode 8, Part 1, clause 4.3.3.5.2 (1) as it is not relevant for the building typologies within the scope of this study. Vertical accelerations are more significant for structures of large span or cantilevers.

Vertical upward acceleration will cause a reduction in friction between surfaces transferring load in bearing, and therefore the connection tie force between floors and roofs tied to walls that rely on this bearing. This is another reason to ensure that these elements are all positively connected to ensure adequate seismic performance.

This methodology is appropriate for masonry structures at relatively low levels of seismic demand. As the seismic level rises, the response of the building becomes increasingly non-linear and the degree of accuracy decreases.

The Modal response spectrum analysis is:

- Quick and simple to create analysis models;
- Good for complex geometries and higher modes;
- Consistent with the approach used in Belgium^[20] (for a PGA of 0.1g);
- Amenable to the extraction of connection forces, and
- Suitable for large-scale implementation.

The drawbacks include:

- Complexity of post-processing connection forces from 2D shell elements at interfaces;
- Analysis processing time can be significant for large, complex models;
- Less representative of actual masonry behaviour as PGA increases; and
- Cannot deal with seismic duration-related effects.

2.5.3 Modal response spectrum analyses using equivalent frame method

This methodology is similar to the method described in 2.5.2 but with selected 2D shell elements replaced by beam elements. This simplifies the model and reduces the size, and although a slightly more conservative approach, provides a method which is quicker to implement; more intuitive for engineers to apply and more straightforward to verify. The method is suitable for houses and other structures with load bearing walls and intermediate horizontal elements.

The benefits of this approach are:

- Analysis time;
- Post-processing time/complexity;
- More amenable to checking/verification;
- Straightforward extraction of connection forces;
- Suitable for large-scale implementation, and
- Can be readily developed into a non-linear macro-element model (see below).

The drawbacks are:

- The initial set-up requires a higher level of expertise/judgement;
- Splitting and then recombining of gravity and seismic effects which involves an additional step;
- Slightly more conservative than the 2D shell element analysis approach;
- Unable to readily capture connection tie forces; and
- Cannot deal with seismic duration-related effects.

2.5.4 Non-linear static pushover analysis using macro elements

This methodology is a development of the approach above using special macro elements to model the non-linear in-plane behaviour of masonry.

The benefits of this approach are:

- Improved representation of certain typologies, especially for higher PGAs;
- Less conservative approach – models material non-linearity;
- An analysis model can be developed from the Equivalent Frame method described above; and
- The model can be further developed to accommodate dynamic cyclic loading and incorporate associated material degradation effects.

The drawbacks are:

- Initial set-up requires a higher level of expertise/judgement;
- Initial model set-up time;
- Limited to structures dominated by the highest modes only;
- Unable to readily capture connection tie forces;
- Cannot deal with seismic duration-related issues; and
- Less amenable to a design guide or for large-scale implementation (specialist software and engineering expertise are required).

2.5.5 Non-linear static analyses using mechanism-based elements

This method pre-supposes specific failure mechanisms and utilises a kinematic approach to assessing seismic capacity. It is particularly suitable for relatively massive masonry elements both in and out-of-plane. As a result it is particularly suitable for monumental-type structures.

The benefits of this approach are:

- Improved representation, and therefore accuracy, of certain typologies for higher PGAs;
- Effective for buildings with pre-existing cracks that could precipitate a failure mechanism; and
- More accurate non-linear approach compared to linear methods suitable for monumental buildings.

The drawbacks are:

- Initial set-up requires a higher level of expertise/judgement;
- Initial model set-up time;
- Less amenable to a design guide or for large-scale implementation (specialist software and engineering expertise);
- Cannot deal with seismic duration-related issues; and
- Not applicable to cavity wall construction.

2.5.6 Non-linear time-history analysis

This approach is the most sophisticated and can model geometric and material non-linearities together with time-history signals. Models can be large and complex and refined to a brick-by-brick level of detail. Due to the time needed to generate and analyse these models, they are generally used to investigate specific behaviours of specific structures. Entire buildings can be modelled at a high level of detail, but the technique can also be deployed to investigate sub-systems to calibrate simpler models.

The benefits of this approach are:

- Most representative model of actual building or element behaviour;
- Most accurate of all; and
- Direct modelling of geometric and material non-linearities.

The drawbacks are:

- Time – preparation/analysis/post-processing;
- Specificity and sensitivity to inputs;
- Not amenable to large-scale implementation;
- Limited skill/experience base in the local engineering community; and
- Checking and verification is complex.

2.6 Development of Legal and Regulatory Framework

For tectonic earthquakes in the EU the framework for assessment of strength is Eurocode 8. In relation to casualties, the purpose of Eurocode 8 is to ensure that in case of a seismic event lives are protected. To satisfy this, the ultimate limit states associated with collapse or with other forms of structural failure, which might endanger the safety of people or continuity of critical operations, are checked.

Eurocode 8 is localized for each country of the EU by the use of a National Annex with Nationally Determined Parameters (NDPs) which focus on the following issues:

- Seismic hazard;
- Site response; and
- Applicability to local construction.

For the Netherlands there is currently no National Annex and NDPs and Eurocode 8 is not required by the Dutch Legislation (Bouwbesluit 2012). The use of Eurocode 8 in the Netherlands is on a voluntary basis, however it would require a National Annex and NDPs. Development of the National Annex and NDPs is foreseen by the NEN institute.

The development of the Eurocode 8 National Annex for the Netherlands is expected to take several years. Therefore it has been proposed to develop a national code of practice (NPR) as a precursor for this National Annex. The NPR will be developed by the NEN-institute. The learning of the upgrading studies will be available to the NPR-committee as input for the development of the NPR.

It is not possible to set long term policy with current large uncertainty ranges. Therefore it is recommended that the NPR should focus on the coming three to five years.

Eurocode 8, Part 3 addresses only the structural aspects of seismic assessment and retrofitting. This standard will apply once the requirement to assess a particular building has been established. Eurocode 8, Part 3 is not very comprehensive or sufficiently detailed to give appropriate guidance for the structural upgrading measures for the Groningen region. Additional design requirements and design guidance, which are not provided by Eurocode 8, Part 3 and required for performing the structural upgrading assessment are summarised below.

The design guidance described in this report will be based on:

- PGA contour maps for the Groningen region applicable to the seismic hazard design level, provided by KNMI;
- Target building performance defined by the limit state of Significant Damage (Eurocode 8, Part 3), using earthquake hazard levels of 10% probability of being exceeded in 50 years (equivalent to an earthquake return period of 475 years). The Operational performance level is defined by the Damage Limitation limit state, using earthquake hazard levels of 20% probability of being exceeded in 50 years (return period 225 years). This holds for both new and existing buildings;
- Use of Eurocode for design guidance on performance evaluation and structural upgrading measures. The use of ASCE 41-13 (currently in Draft) as design guidance for performance evaluation for elements and aspects that are not covered by the Eurocode, specifically Eurocode 8;

- Use of structural upgrading measures from other countries with similar construction as the basis for local structural upgrading measures (Belgium, UK, Italy and the USA);
- Use above design guidance as input to a concept NPR for existing buildings to ensure a legal and regulatory framework.

3 Scope of Study

The purpose of this section is to define the scope of the study in terms of the characterisation of the building stock in the Groningen region and the analysis studies for buildings and building elements.

This study assesses the performance of selected buildings representing typical, damaged, historical, and other buildings. To date, 16 buildings have been assessed:

- Eight typical buildings of six sub-typologies:
 - terraced house
 - semi-detached house
 - detached house
 - labourer's cottage
 - mansion
 - villa
- Four damaged buildings;
- One historic church; and
- Three other buildings:
 - one school
 - two utility buildings

3.1 Building Typologies

Typical building types are representative for a significant proportion of the building stock, while unique buildings are one of a kind. Lessons learned from the study of typical and unique buildings will be captured in the design rules and protocols.

The study area, shown in Figure 14 is centred northeast of Groningen and represents a 5km band beyond the extent of the Slochteren gas field. In this area of approximately 1475km², some 275,000 premises exist, all with different functions, shapes and sizes.

Buildings have been categorised in four main building typologies:

- **Typical buildings** – including houses, represent the largest proportion of buildings and can be divided into a number of sub-typologies representative of the majority of the total building stock in the region. Eight different buildings have been assessed based on covering a representative sample of the most common typologies in the area.
- **Damaged buildings** – potentially have an increased seismic risk and may need prioritization. Four specific buildings have been assessed to date, including assessments of the existing condition of each.
- **Historic heritage buildings** – require specific and sensitive upgrading measures to preserve their visual appearance. One church has been assessed; and
- **Other buildings** – are a mixed group with different materials or combinations of materials structural typologies. Schools, hospitals and utility buildings fall into this category. One school and two utility buildings have been assessed to date.

Building typologies 1, 3 and 4 have specific sub-typologies.

3.1.1 Typical buildings

Initially, the description of Typical buildings was defined by the type of houses located within a radius of around 15 km from the centre of the heavy seismic event indicated in Figure 15. The type of houses consists primarily of two storey high unreinforced masonry houses. Recently the seismic study area has been expanded and includes more urban areas, which comprised multi-storey buildings. This category of buildings has not been included in the above described typologies.

Based on the GIS database, which contains information about 275,000 individual buildings in the area of interest, a system was developed to categorise all of these buildings based on their age, height and expected material of construction. These categories were used in both studies, although in slightly different ways.

The Seismic Risk Study (see Table 8) identified 19 building typology categories, which were selected based on information that could be readily found from existing databases for the area. Buildings typologies were distinguished by building material, age, number of storeys and type (only detached, semi-detached and terraced houses were distinguished). These typologies were selected to allow empirical fragility functions (based on statistics collected in previous international earthquakes) to be assigned to typologies. Twelve of the typologies contain unreinforced masonry buildings, two typologies contain reinforced concrete buildings and the other five typologies contain steel buildings, timber buildings or buildings from which the structural material is unclear.

Since unreinforced masonry is the most common construction material for houses and is the most vulnerable construction material in case of seismic events, the structural upgrading study focusses on this construction material. The buildings assessed within this structural upgrading strategy study are selected based on an initial inspection of building stock and are considered representative for the typologies in the region. There is not a one-to-one correlation between buildings considered in the Seismic Risk Study and those considered in this study. Nevertheless, Table 8 shows a mapping between the Seismic Risk Study categories and the selected buildings for the Structural Upgrading Study.

Table 8 Building Typologies – Seismic Risk Study (RA) & Structural Upgrading Study References.

Typology RA	Type	Floor	Period	Storeys	Structural upgrading Sub-typologies
URM 1	Detached / Semi-detached	Flexible diaphragms	Pre 1920	1-2 storeys	T3a, T4, T5
URM 2				≥ 3 storeys	T6
URM 3			1920 – 1960	1-2 storeys	T2a, T3a, T4, T5
URM 4				≥ 3 storeys	T6
URM 5		Rigid diaphragms	Post 1960	1-2 storeys	T3b
URM 6				≥ 3 storeys	T2b
URM 7	Terraced buildings	Flexible diaphragms	Pre 1920	1-2 storeys	-
URM 8				≥ 3 storeys	-
URM 9			1920 – 1960	1-2 storeys	-
URM 10				≥ 3 storeys	-
URM 11		Rigid diaphragms	Post 1960	1-2 storeys	
URM 12				≥ 3 storeys	T1









Based on the GIS database and site visits to the region common sub-typologies were identified for the structural upgrading study and are summarised below:

For the terraced buildings, T1, the sub-typology believed to be the most common comprises concrete floors at ground, first and attic levels with cavity walls founded on piles.

Similarly, for the semi-detached buildings, sub-typology T2b with concrete floors; cavity walls and piled foundations is believed to be the most common. A more detailed breakdown of sub-typologies of typical buildings can be found in Appendix C.

Based on the database of buildings in the region the most common sub-typologies were identified and are summarised below. One example each of types 1 – 8 in Table 9 have been studied as part of the Typical Buildings study.

Table 9 Characteristics of Typical Buildings.

Nr	Type	Image	Floor	Note
1	T1 Terraced house		Concrete	80% of the terraced houses built after 1960. Concrete was introduced as a building material for regular houses around 1953. Therefore it is assumed that primarily concrete floors are used for terraced houses.
2	T2a Semi-detached		Wood	
3	T2b Semi-detached		Concrete	65% of the semidetached houses built after 1960. Therefore it is assumed that primarily concrete floors are used for semi-detached houses.
4	T3a Detached		Wood	50% of the detached houses built after 1960. At least 40% of all detached houses will have wooden floors only. The other 60% may contain wooden floors, concrete floors or both.
5	T3b Detached		Concrete	
6	T4 Labourers cottage		Wood	Typical building found in rural areas in the neighbourhood of farms
7	T5 Mansion		Wood	Typical square building found in towns and villages in the region
8	T6 Large masonry villa		Wood	Large masonry residence containing a ground level and at least 2 stories. Richly decorated with ornaments and generally well maintained.

3.1.2 Damaged buildings

Damaged buildings are buildings where damage has been reported in the past and where a damage survey has been conducted. These buildings are, according to the damage reports, in a 'critical condition'.

The four buildings studied in this phase have been selected by NAM. The location of these four buildings is shown in Figure 14 below. Damaged buildings assessed in this part of the study included a large old house which has had several alterations and extensions; a farmhouse constructed in two phases and two timber-framed barns.

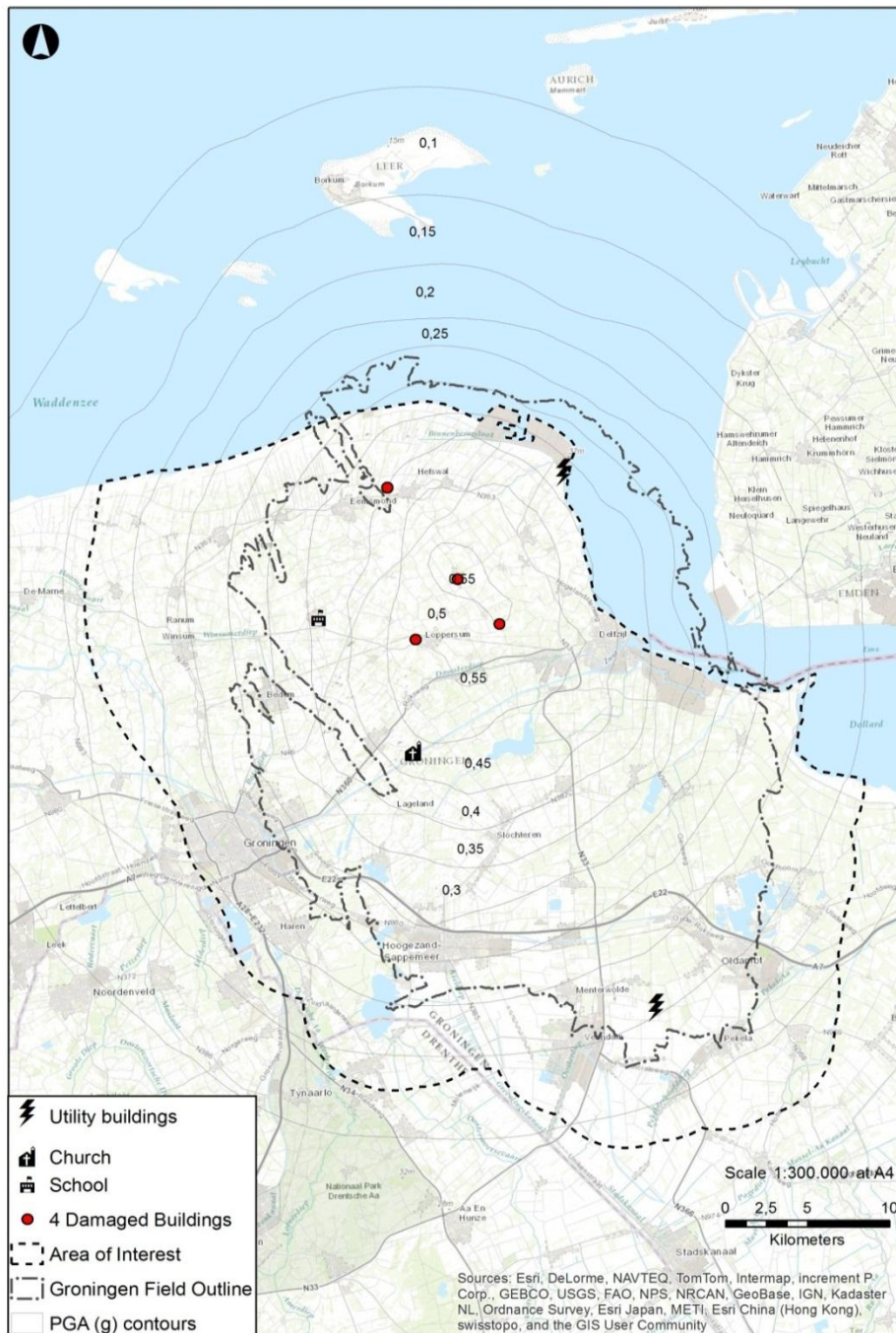

Figure 14 Hazard map with investigated building locations (contours according to Figure 6)

3.1.2.1 Pre and post-upgrading seismic evaluation

For each of the damaged buildings, a pre-upgrading seismic assessment has been undertaken on the basis that sufficient ties and diaphragm action were present to distribute seismic effects – in anticipation that these would be needed to provide adequate seismic resistance.

For the buildings investigated to date, the design of upgrading measures has been provided that does not significantly alter the mass or stiffness of the building. Therefore the overall seismic behaviour from an analysis perspective will not significantly change as a result of the structural upgrading measures. In case the mass or stiffness don change due to the structural upgrading measures, post-upgraded seismic evaluation will be necessary and for the post-upgraded buildings the same analysis and design procedure is followed as for the pre-upgraded building.

3.1.3 Historical buildings

Historical buildings provide special civic amenity. They often comprise large masonry elements attracting high seismic loads and use different structural systems than domestic-scale buildings. Therefore, the assessment methodology can be different from smaller-scale buildings.

The selection and development of upgrading measures involves specific consideration to maintain the appearance.

One historical church building has been assessed to date.

3.1.4 Other buildings

Other Buildings is a category used to capture important buildings not covered by the other categories. The following buildings have been assessed:

- **The school** is particularly important because of the large congregation of children and staff during the day. By their nature, schools tend to comprise a series of extensions built at different times using different construction methods. Therefore they have a certain complexity for seismic assessment;
- **Utility building 1** is an electricity transformer enclosure; and
- **Utility building 2** is a pair of adjacent structures used for gas distribution. There is a particular requirement to allow the roof to detach in the event of a gas explosion.

Structural upgrading measures for the utility buildings have been assessed on the basis that the buildings should be operational immediately after the design seismic event (currently a PGA of 0.25g) and to ensure minimal disruption to operation during implementation of the upgrading measures.

3.2 Selected Buildings: Pilot 1 Phase 1

The following section describes the studies undertaken on the selected buildings, and summarised in the table below.

Table 10 Total Buildings Assessment Methodology

Building		Typicals							Damaged				Historic	Other Buildings			
Typology		T1	T2a	T2b	T3a	T3b	T4	T5	T6	D1	D2	D3	D4	Church	School	Utility 1	Utility 2
Performance Objective		LS	LS	LS	LS	LS	LS	LS	LS	LS	LS	LS	LS	LS	LS	IO	IO
ATC-20										Completed	Completed	Completed	Completed				
ASCE 41-13 Tier 1										Completed	Completed	Completed	Completed	Completed	Completed		
ASCE Tier 3	Lateral Force Method				Completed												
	Linear Dynamic Modal Response Spectrum Analysis - Equivalent Frame				Completed												
	Linear Dynamic Modal Response Spectrum Analysis - 2D Elements	Completed	Completed	Completed	Completed	Completed	Completed	Completed	Completed	Completed	Completed	Completed	Completed		Completed	Completed	Completed
	Non-Linear Static Pushover Analysis - Macro Elements	Planned	Planned	Planned	Completed	Planned	Planned	Planned	Planned	Planned	Planned	Planned	Planned		Planned		
	Non-Linear Static Analysis - Mechanism-based Elements													Completed			
	Non-Linear Dynamic Time-History Analysis	Completed	Planned	Planned	Completed												



3.2.1 Performance requirement

The buildings studied have deliberately been chosen to represent a range of performance requirements. In terms of EC8, most buildings fall under Importance Class II with the exception of the barns (Class I); the school (Class III) and the Utility Buildings (Class IV).

In terms of ASCE 41-13, the assumed performance-based requirements are the Life Safety performance level for all buildings except the utility buildings for which the Immediate Occupancy performance level has been assumed.

3.2.2 Condition assessment

For buildings with pre-existing damage, an initial safety assessment to ATC-20 was undertaken followed by a damage assessment according to ASCE 41-13 Tier 1 Screening. This was followed by a Tier 3 evaluation to ASCE 41-13 taking into account seismic retrofit interventions.

3.2.3 Analysis method

In order to test the relative sensitivity of different building typologies to a given seismic event, all buildings, with the exception of the church, were assessed with the modal response spectrum analysis using 2D elements with a PGA of 0.25g. Due to its specific characteristics, the church was analysed using the non-linear static push-over analysis using macro elements.

In order to test the relative sensitivity of the different analysis methods, all methods, with the exception of the non-linear static analysis using mechanism-based elements were applied to the same building (T3a), and tested for a PGA of 0.25g. For the non-linear methods, different levels of PGA were used.

One of the more vulnerable buildings, T1, (see Figure 16) was also assessed with both the modal response spectrum analysis method using 2D elements and the non-linear time-history analysis to test the sensitivity of approach for a building with a high degree of non-linear behaviour.

3.3 Building Element Studies

3.3.1 Cavity walls

Cavity walls were originally modelled as solid walls, which overestimates stiffness and were therefore conservative. The purpose of undertaking the cavity wall study was to quantify the potential conservatism and develop means to reduce this. The ASCE assessment methodology of walls limits its scope of applicability to certain geometric criteria, which are not met by Dutch cavity walls and the building stock under investigation. Therefore, additional studies have been undertaken to test these limits and explore the potential for extending them.

3.3.2 Soil-structure interaction and foundations

The purpose of undertaking these studies was to address two shortcomings of the linear models which were based on the assumption of pinned foundations:

- They overestimate the global stiffness and therefore underestimate the natural period of the building which governs its dynamic response, and
- They assume boundary conditions which can generate tension at the foundation which for many foundations is not realistic, once PGAs rise above a certain threshold, compared to the gravity loads in the element under consideration.

The study was also needed to form a preliminary assessment of the existing foundation capacity.

4 Results

The purpose of this section is to present the results of the preliminary analyses and studies on total buildings and building elements in terms of seismic performance. This section explores the sensitivity to analysis methodology and proposes suitable methods for different building typologies. Structural upgrading measures are subsequently characterised into levels of intervention required to achieve the target level of seismic performance.

4.1 Seismic Performance – Building Level

4.1.1 General

The discussion below steps through the studies undertaken and identifies the key findings and trends. The following section sets out the recommendations moving forward based on the findings to date.

For the purposes of identifying trends and similar behaviours, the typologies investigated have been grouped into sections which are discussed below based on observed similar characteristics and/or performances resulting from phase 1 analyses. All buildings investigated rely on load-bearing masonry walls to provide the lateral stability system to resist seismic loads.

4.1.1.1 Relative performance

Although the number of typical building studied is limited, the following factors are seen to influence building performance:

- Wall openness;
- Wall type; and
- Building mass (which is a function of mass of floor construction and number of storeys).

Based on modal response spectrum analysis, two groups are distinguished:

- **The more vulnerable** typical building sub-typologies, comprising terraced buildings and semi-detached buildings; and
- **The less vulnerable** typical building sub-typologies, comprising detached house, labourer's cottage, mansion and villa.

The more vulnerable typical building sub-typologies are directional in their structural configuration and performance and are particularly vulnerable in the direction parallel to the front and rear façades. These façades are relatively open.

This openness is facilitated by the design methodology commonly used to design these buildings for resistance to wind load on the gables, which results in relatively narrow masonry piers per terraced house to resist lateral loads in that direction. In this group all the buildings are three storeys and all walls are cavity walls. Buildings with heavy concrete floors display weaker performance compared to buildings with lighter timber floors.

The less vulnerable typical building sub-typologies are non-directional. In this group most buildings are two-storeys and most buildings have solid walls. Buildings with heavy concrete floors display weaker performance compared to buildings with lighter timber floors.

Buildings with shop fronts, though not explicitly studied, are expected to perform similarly to more vulnerable typical building sub-typologies based on similar structural arrangements of load-bearing members.

Note that the differentiation in more and less vulnerable buildings is not yet made in the fragility curves used in the seismic risk study. At present the fragility curves represent a statistical representative estimate for all buildings with a differentiation only according to age. When more information becomes available about relative vulnerability this will be taken into account in the seismic risk study.

4.1.1.2 Actual performance

Assuming that the upgrading measures level 2 and 3 have been implemented, the threshold for partial collapse (Damage State 4 = DS4), such as wall failure, is used for assessing the building performance.

Modal response spectrum analysis shows partial collapse (DS4) at PGA's smaller than 0.1g. This is not consistent with the experience at the Huizinge earthquake where maximum PGA's of 0.08g were observed and damage was cracking at walls only (DS1 and DS2).

Non-linear analysis shows partial collapse (DS4) for PGA between 0.15g to 0.5g dependent on building sub-typology and non-linear analysis method. For the sub-typologies studied – terraced houses and detached houses - partial collapse was observed at PGAs of respectively 0.3g and 0.5g on the basis of sophisticated non-linear time history analysis. Using the non-linear pushover analysis partial collapse was observed between 0.16g and 0.24g on the detached house sub-typology.

Definite conclusions about structural upgrading beyond level 3 is difficult, although these preliminary results show that the threshold where upgrading beyond level 3 is needed is tentatively between 0.15g and 0.5g. To be more confident the non-linear analysis needs calibration with physical laboratory tests.

4.1.2 Spectral response of buildings

Figure 15 shows the modal response of a typical terraced house. The location of the circles represents the modal frequency plotted on the response spectrum. The relative sizes of the circles represent the contributing relative modal mass for a given mode.

The observed trends are as follows:

- Most of the buildings have their significant modes on the plateau of the Eurocode 8 framed response spectrum, albeit at different positions along the plateau;
- The spectra for the semi-detached buildings suggest that the main modes are near the edge of the plateau. However, this typology is very flexible in one direction, and once strengthened, it is likely that the response will be further to the left on the plateau;
- The large mansion has relatively high floor-floor heights and high proportion of windows in the elevations. Therefore it is relatively flexible and its principal modes are towards the right hand side of, but still on, the plateau;
- The timber-framed barns are much more flexible than the other buildings; have longer periods and therefore attract a much lower seismic demand. Unlike the other buildings investigated, wind loads on the barns exceed the seismic load;

- Site-specific response spectra are likely to have a shorter plateau than the Eurocode 8 spectrum used and be more representative than Eurocode 8 at longer periods. The evidence is the ASB13 M=5 R=3km curve, also plotted by way of example. Therefore establishment and use of site-specific spectra may reduce the seismic demand on some buildings; and
- The response of the buildings can be expected to soften once the foundation and soils are modelled. Preliminary models indicate an increase in period as expected. For the terraced building below, the modal periods increase, but not to the point where they fall off the plateau and start reducing base shear. This effect differs for different building typologies and should be investigated further on other typologies. The base shear could decrease or increase depending on the initial position of the principle modes on the response spectrum.

Typical 1

Main Modal Shapes

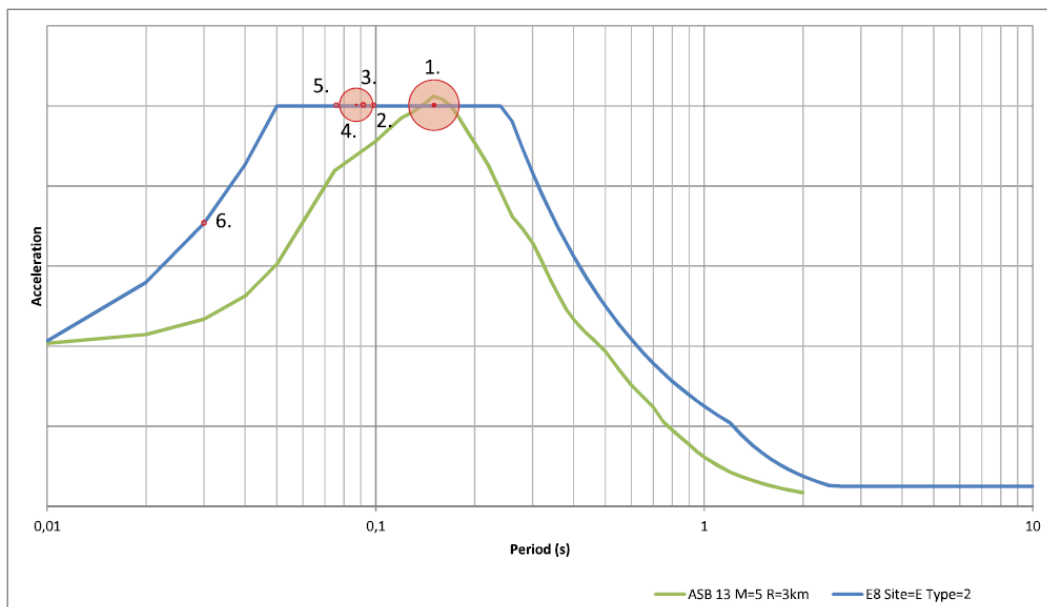

Figure 15 Spectral Response of Terraced Buildings.

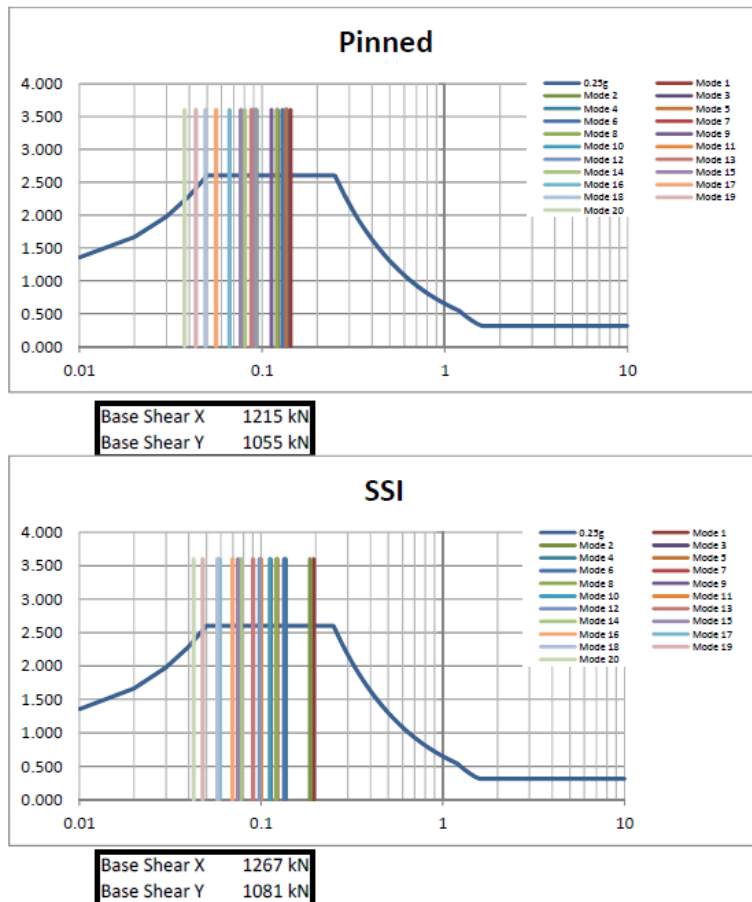

Figure 16 Spectral Response of Terraced Buildings with and without soil-structure interaction.

4.1.3 Connection forces

A summary of the connection forces for the typical buildings has been presented in Table 11.

The summary represents typical tie force levels, with extreme values filtered out for special connections. In general, buildings with relatively heavy concrete floors, and therefore higher base shear forces, tend to have higher connection forces, but the results are also sensitive to geometry and the presence of return and cross-walls. Therefore, clear patterns were not obvious from the summary of analysis results alone and a simplified methodology has been developed to determine those connection forces for individual buildings.

4.1.4 Masonry pier capacities

A summary of the demand/capacity ratios (D/C ratios) of the wall piers for the typical buildings in the direction parallel to the front façade is represented in Figure 17.

The terraced and semi-detached buildings have much higher utilisation ratios than the other typologies due to their vulnerability in X-direction (x-direction parallel to front and rear façade). The semi-detached buildings appear to be more vulnerable than the terraced houses but this is a function of their connectivity to attached garages which contain piers with very high demand/capacity ratios.

For otherwise identical buildings, those with concrete floors are more vulnerable than those with timber floors due to the higher base shear forces resulting from greater seismic mass.

Table 11 Summary table of connection forces

Typical Buildings	Connection forces based on 0,25g from GSA model								
	Wall to Wall			Floor to Wall			Roof to Wall		
	F _x	F _y	F _z	F _x	F _y	F _z	F _x	F _y	F _z
	vertical	out of plane	in plane	vertical	in plane (shear)	in plane (normal)	vertical	in plane (shear)	in plane (normal)
	[kN/m]			[kN/m]			[kN/m]		
T1 Terraced	85	3	12	2	23	5	0	9	4
T2a Semi-detached Timber	79	12	36	17	12	22	9	19	26
T2b Semi-detached Concrete	79	12	36	17	12	22	9	6	25
T3a Detached Timber	15	3	17	0	8	4	8	5	6
T3b Detached Concrete	32	3	21	2	18	10	8	7	13
T4 Labourer's Cottage	11	3	12	1	4	3	5	4	3
T5 Mansion	25	3	15	0	6	9	5	5	5
T6 Large Villa - main building	49	4	50	2	0	0	5	5	6

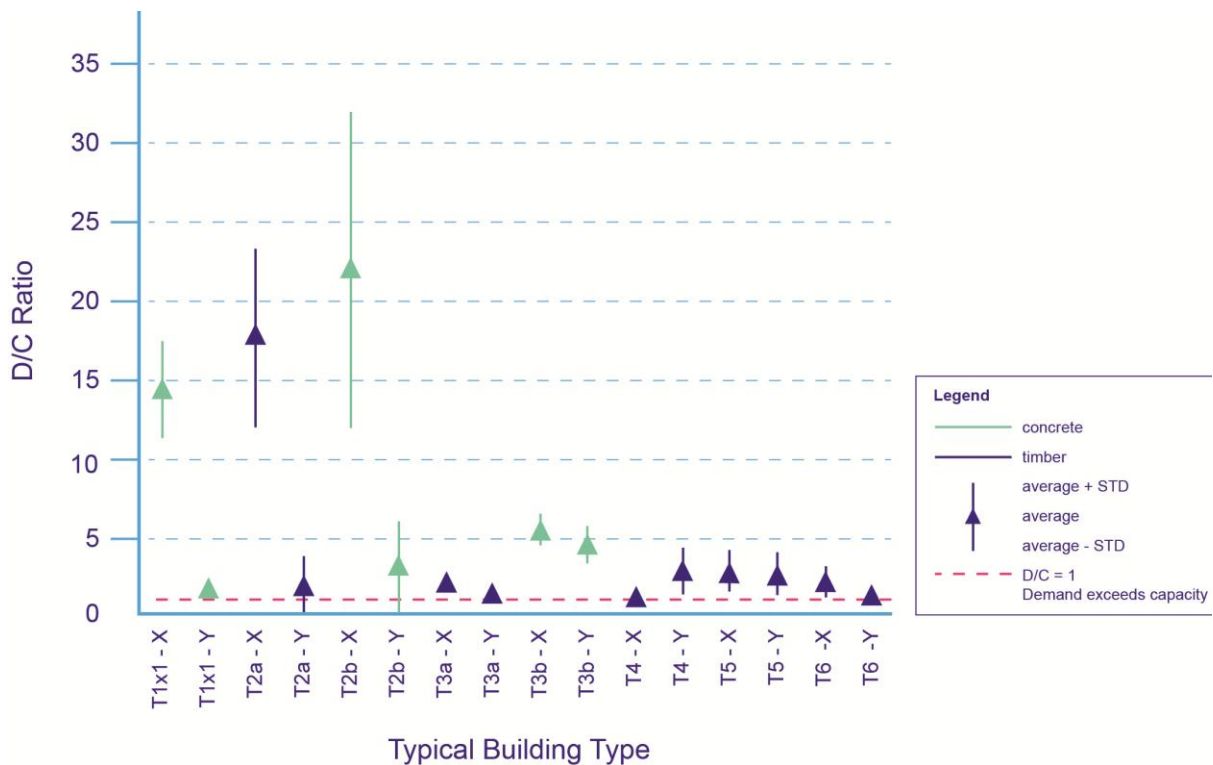

Figure 17 Relative Vulnerability of Building Typologies based on Wall Strength

4.1.5 Terraced and semi-detached houses

Both terraced and semi-detached houses represent a very high population of dwellings in the study area, and are particularly vulnerable in the direction parallel to the front and rear façades. The original design process for buildings of these typologies for imposed wind loads on gable ends results in small shear walls in this direction which may be distributed over several connected dwellings. Therefore the amount of shear wall available per dwelling to resist seismic effects is very limited.

The buildings studied suffer from torsional irregularity, due to the connected garages. For these buildings, the preliminary proposal is to disconnect the garage or demolish and re-build as a self-supporting structure.

These typologies commonly have a cavity party wall comprising two load-bearing untied leaves of masonry. These will require structural upgrading both in-plane and out-of plane. Gable walls, particularly cavity walls, also require structural upgrading.

Temporary measures have been explored to provide rapid risk reduction. Temporary structural frames for the most vulnerable buildings can be designed, procured and installed quickly on a large scale. The structural system in the most vulnerable direction needs to be upgraded, and there is the opportunity to replace existing façades as part of the permanent solution with a seismically-robust design that also improves the thermal and acoustic performance of the building.

There are many sub-typologies that require further investigation, particularly in the higher seismic hazard regions.

Although the non-linear time-history analyses indicate more favourable behaviour than the modal response spectrum analysis used (see Section 4.3.5), substantial damage with very large cracks and collapse of veneers was observed at PGAs of 0.2g and 0.3g respectively, demonstrating potential vulnerability at relatively modest ground motion levels.

4.1.6 Detached houses, mansions and labourer's cottages

The general characteristics of these typologies are that they are freestanding and consist of two storeys, the uppermost of which is within the pitched-roof space.

For the detached house, two construction forms typical of pre and post-1960s house construction methods have been considered; solid masonry perimeter walls with a timber floor system (T3a) and cavity perimeter wall system with a precast lattice slab (T3b). The Labourers cottage (T4) has a pitched timber roof and timber first floor. The Mansion (T5) has a timber-framed mansard roof and timber first floor. Both T4 and T5 have solid masonry perimeter walls.

The sub-typologies with solid perimeter walls have adequate proportions to be stable out-of-plane. Those with cavity walls require supplementary upgrading.

In-plane, perimeter walls would require structural upgrading for low PGA values of approximately 0.05-0.1g based on the findings of the current linear analysis methodology.

T3a (villa) has been studied using a range of analysis methodologies to investigate the sensitivity of outcomes to methodology (see Section 4.3). The most sophisticated analysis methodology suggests significantly greater seismic resistance than the above indicated 0.1g.

4.1.7 Large villas

The general characteristics of this typology are that it is freestanding and comprises a ground floor level and 2 storeys above ground floor level. Therefore, it has an additional storey compared to the typologies considered before. This typology has a high proportion of windows and consequently less masonry in elevation, and is therefore relatively flexible. Consequently, the large villas have a longer natural period than the other building typologies; though insufficiently long to drop off the Eurocode 8 response spectrum plateau. Once soil-structure interaction studies have been undertaken, some benefit is likely with the structure becoming more flexible, having a longer natural period and thereby potentially attracting lower base shear forces.

Extensions and modifications over the years may have taken place and added plan irregularity as well as elevational irregularity, which generally make them more vulnerable.

The resulting structure has limited structural capacity to resist seismic loads, and would require structural upgrading of walls at low levels of PGA according to the preliminary analysis findings.

4.1.8 Barns and other timber-framed agricultural buildings

The two barns investigated to date comprise timber-framed structures acting in conjunction with masonry perimeter shear walls. They are relatively tall buildings and are relatively lightweight and much more flexible than all other typologies investigated. Consequently, they have longer natural periods and attract limited base shear force. The governing overall lateral load is wind rather than from seismic action.

Although the seismic loads are less than those from wind, the distribution is different, and timber members, particularly joints, need to be reviewed for seismic capacity as part of a subsequent detailed assessment. Local in and out-of-plane stability of the masonry walls limits their capacities, and these require structural upgrading to resist seismic loads. Structural upgrading of the foundation was required for one of the barns at a PGA of 0.25g.

Mezzanine structures add unfavourable effects under seismic events. The preliminary recommendation is to disconnect these and provide them with independent lateral load-resisting structural systems.

The barns have been assessed with an equivalent Importance Factor of 1.0. As they are Importance Class I buildings to Eurocode 8, there is scope to reduce conservatism in the overall approach.

4.1.9 Church

The church is an historic building composed of a nave, approximately 12m by 18m in plan, and a bell tower approximately 25m tall. The walls of the church are built entirely of masonry, up to 900mm thick at the base, with a timber framed attic space which is covered with timber roofing and with roof tiles. The church was constructed in at least two phases, with different masonry clearly evident in each section.

Unlike the other buildings in this study, the church was assessed using a mechanism-based analysis methodology, which is more appropriate for structures of this nature. This is a non-linear, static approach, the geometry for which was generated from a digital laser-scanning survey.

The bell tower is leaning significantly away from the building, and cracks exist between the tower flanking walls and the remainder of the structure. Preventing further movement/rotation of the bell tower should be a priority irrespective of possible future seismic action.

A conservation philosophy has been adopted with respect to structural upgrading, and thus recommendations for remediation of the bell tower include a series of post-tensioned steel ties; CAM belting; steel strapping and lime or cement injection-grouting. Remediation methods have been developed in recognition of the visual sensitivity of the building.

The building is included in the National Register of cultural heritage as a Rijksmonument. At this point, it is unknown what impact this will have on the structural upgrading measures. The concept design of the structural upgrading measures will need to be discussed and agreed with the Cultural Heritage Agency (Rijksdienst voor het Cultureel Erfgoed).

4.1.10 School

The school was constructed in two phases and comprises a collection of inter-linked spaces with a mixture of pitched and flat roofed areas forming a complex and irregular roofscape. The pitched roof areas' structures comprise steel frames supporting the roof timber purlins and unreinforced masonry walls. The flat roof area's structures comprise unreinforced masonry walls supporting the roof timber beams.

The lateral stability system relies mainly on cantilevered masonry shear walls arranged in orthogonal directions and on steel frames for the transverse lateral actions in the classrooms.

The modal response is complex, reflecting the geometric complexity of the structure, but all significant modes lie on the plateau of the response spectrum, resulting in high base shear force.

The main issues with seismic resistance relate to the lack of a roof diaphragm, in-plane URM wall capacity and connection capacity between walls and diaphragms. Consequently, substantial structural upgrading is necessary to achieve adequate performance under higher seismic loads.

4.1.11 Utility buildings

4.1.11.1 General approach

Two utility buildings have been assessed to date; an electricity transformer enclosure and a gas distribution facility. These differ from the residential buildings in that they are assumed to be required to be operational after the design seismic event. Upgrading measures have been determined such that can be undertaken externally with minimal impact on business continuity.

These buildings are assumed to be Importance Class IV to EC8, with an associated importance factor of 1.4. As the assessment has been carried out to ASCE 41-13, the performance level has been targeted at Immediate Occupancy performance level, to ensure that the building is operational after the design seismic event by limiting the post-earthquake damage to a condition which is safe to occupy without need for substantial repair. Consequently, the importance factor has been set to 1.0 and no up-scaling of the response spectrum is required in order to maintain consistency between codes.

The assessment of URM capacity for Immediate Occupancy is similar to that for Life Safety in ASCE 41, except that the acceptance criteria are more rigorous. This is intended to minimise damage by limiting the degree of inelastic behaviour.

The upgrading measures have been developed to respect original functional building design intent, such as venting of roof plate for the gas building in case of explosion, and avoidance of internal upgrading measures that might generate sparks. The buildings may also have specific internal environmental control requirements such as avoidance of condensation. Further information is needed from the service provider such that these can also be incorporated into a structural upgrading solution.

4.1.11.2 Electricity utility building

The electricity utility building is approximately 5.5m x 5m on plan and 2.6m in height. The structure is comprised of unreinforced masonry cavity walls, a suspended ground floor of reinforced concrete, with various openings to allow for conduits and a roof of reinforced concrete, with a similar thickness compared to the ground floor slab.

Modal response spectrum analysis showed that all walls fail under a 0.25g PGA seismic event, both in-plane and out-of-plane. This failure is due to the cavity wall construction. Additionally, the bearing connection between the floor and roof slabs and the inner leaf of the URM walls is insufficient for providing seismic diaphragm restraint; these connections will also require structural upgrading.

Further investigation into the existing foundations and local soil capacities at the individual building sites is recommended.

4.1.11.3 Gas utility building

The gas utility building consists of two separate buildings, each of which is approximately 3.8m tall from grade to roof. Building A is 4m x 7.7m on plan. Building B is 7.7m x 7.7m on plan. The foundations consist of thickened slab edge turndowns below the walls approximately at grade. The ground floor is a slab on grade. The roofs are lightweight and supported by spanning beams. Both buildings have a parapet 336mm high. The structure is comprised of solid URM walls which provide both the gravity and lateral resisting systems.

The timber roofs are designed to be expansion roofs in case of a gas explosion inside the building. For that reason they cannot be connected rigidly to the walls to be able to transfer significant forces.

The URM walls of the typical gas utility building were evaluated using a modal response spectrum analysis on the basis of a target Immediate Occupancy performance level under a 0.25g PGA seismic ground motion. To achieve this target performance, structural upgrading is required. The assumed operational restrictions for this type of building affecting methods of construction that could be implemented, leading to the recommendation of an upgrading system consisting of exterior applied concrete shear walls with an upper perimeter concrete ring beam. Additionally, interior applied timber sheathing and verticals have been proposed to support walls that cannot be connected to the perimeter concrete shear walls and ring beams.

4.1.11.4 Large utility building

A larger steel-framed building with heavy cladding is currently under review. The initial concept for a possible solution is to replace the cladding system with a lighter-weight alternative whilst maintaining building structural and non-structural performance requirements.

4.2 Seismic Performance – Building Element Level

4.2.1 Cavity walls

An investigation into the anatomy of cavity wall construction in the Groningen region for typical buildings and how this has evolved and developed in recent decades has been undertaken as part of this study.

Investigations have been carried out for different modelling approaches regarding the representation of seismic mass and stiffness to establish overall seismic demand. Connectivity of the leaves is a considerable variable between different buildings. The two leaves are expected to be connected through combinations of wall ties; wall plates; bridging lintels and cills and return walls at the ends. Both leaves also share a common foundation. Many permutations and combinations exist regarding the level of likely interaction. Studies are currently under investigation with linear and non-linear time-history approaches to determine a range of possible interaction values. This is work in progress and although no definitive conclusions have been reached at this time, it is clear that for low PGA values (at least), sufficient connectivity of the leaves may exist such that most of the seismic mass of the outer leaf may be mobilised. The preliminary conclusion is that an appropriate method is modelling the inner leaf only with a modification factor to capture the full mass contribution of the outer leaf. This is consistent with the ASCE 41-13 approach and common practice in Italy. However, this may under-estimate stiffness, particularly at low PGA's. There is the potential to reduce the base shear force by 0-20% depending on the flexibility of the building and the level of connectivity that can be demonstrated compared to the solid wall assumption. This must be reviewed on a case-by case basis for specific buildings.

Out-of-plane capacity is captured in the ASCE 41-13 approach by simple slenderness limits. Investigations have been undertaken using nonlinear time-history analyses to study this further. From the studies to date, the presence of the outer, non-loadbearing leaf has been shown to improve the performance of the wall compared to using the inner leaf only, and larger slenderness values appear to be viable. Figure 18 indicates the h/t ratio limits in ASCE 41-13 and preliminary limits indicated by the analysis results. The limits based on analysis are shown for solid walls and cavity walls, for long and short duration ground motions. For cavity walls, the thickness used in the h/t ratio is based on the thickness of the inner load bearing wythe. Although a larger number of ground motions need to be generated and tested and the findings need to be verified by physical experimental data, the results are encouraging. These suggest that the common proportions used in cavity wall construction may have adequate out-of-plane performance at low PGA levels at least. The results also showed a slight benefit from the shorter duration ground motions (more representative for Groningen) than the longer duration motions, although this also needs to be verified by further study.

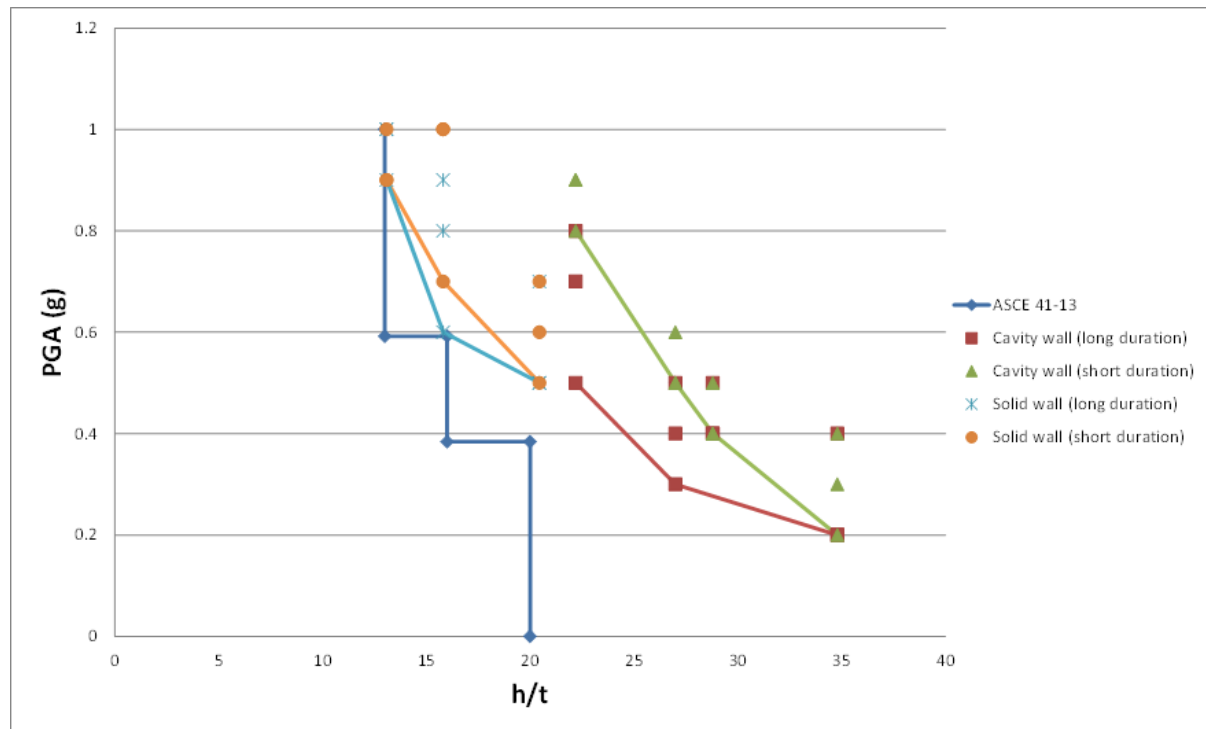

Figure 18 Comparison of LS-DYNA investigations with ASCE slenderness criteria

Although not recommended by current codes, it may be possible to justify mobilising the outer leaf under low PGA's to provide some seismic capacity to raise the in-plane capacity threshold below which seismic retrofit is not required. As this is beyond the scope on any code at present, testing will be required to justify this theory. The ASCE 41-13 restricts the use of masonry walls as shear walls to those with a minimum thickness of 150mm – somewhat larger than used commonly in the Groningen region. Further research into the background of this limitation is underway, and it appears that the body of test data used to inform the ASCE 41-13 guidance did not involve wall thicknesses as low as commonly used in the Groningen region. Further international literary review is currently taking place. It is possible that physical testing of samples representative of local construction methods may demonstrate that thinner leaves are acceptable under the levels of seismic action considered.

4.2.2 Soil-structure interaction and foundations

An iterative methodology has been developed for the linear models to analyse the effects of non-linear soil-structure interaction on the seismic response of the buildings and to check the capacities of the existing foundations.

The soil-structure interaction models have been developed using ASCE 41-13, section 8.4.2.3 *Method 1* with the introduction of massless, uncoupled springs to simulate the response of foundations. This establishes equivalent elastic parameters for the modal response spectrum analysis and provides a useful tool in order to more accurately analyse these structures without excessive computational effort necessary for the non-linear methods such as the time-history analysis. These results are also relatively straightforward to interpret.

The soil-structure interaction for this region and these structures generates a more flexible behaviour when compared to the models with pinned supports.

The subsoil conditions have been categorised into 3 soil types for foundation stiffness sensitivity studies, and 2 zones for seismic response. The scope of this study is currently limited to a 15km radius centred on Huizinge at this stage, but is to be subsequently expanded to the full extent of the overall study.

To date, four typologies have been investigated: terraced house T1, semi-detached house T2b and detached houses T3a and T3b

The preliminary findings are as follows:

- Preliminary studies suggest that most buildings suffer from ground overstress at Peak PGA's of 0.5g, which may lead to excessive deformations. At 0.25g buildings tend to converge at approximately ultimate ground capacities. In particular, at 0.25g T3b exhibits foundation stresses within typical design limits for most localities but only at 0.1g do the stresses fall below the limits for the softer soils;
- T2b is characteristic for having large openings throughout leading to many short segments of rigid shallow foundations and shows very high localised stresses above 0.1g. Therefore structural upgrading of foundation may be required pending further study on specific building details. The foundation capacities are particularly sensitive to embedment depth, for example;
- The fundamental period shift from the original pinned structure fundamental period varies for different structures and increases for larger PGA's. In general for a PGA of 0.25g the period shift is roughly around 1.5 times. For a PGA of 0.5g the period shift increases to values of 2 or greater. As a result of this the overall seismic forces vary since there is a shift in the modes along the response spectrum (see Figure 16). The result may be greater or smaller depending on the original position of the fundamental period and the position of higher modes along the design response spectrum;
- Soil capacities for shallow foundations show very low bearing capacity. Buildings with little or no embedment of their shallow foundations will be most susceptible to bearing capacity failure even under relatively small PGA's and will require structural upgrading measures for their foundations. If reinforced concrete footings tend to have less embedment due to their lower depth, then newer buildings on reinforced concrete strips may perform more poorly than older buildings on masonry foundations with high embedment;
- Generally, minimum demand on soil stresses occurs for C factors (soil degradation factors) between 0 and 0.25 (almost full softening of soil under short foundation strip segments). This shows that even when a converged model exhibits stable foundation results; it may have associated local failures under the short segments around large openings in the wall; and
- Foundation checks show that for higher PGA's of approximately 0.5g, the ratio of base shear to weight is up to 75%. These values could represent the occurrence of sliding of the foundation. Other stabilizing mechanisms such as passive resistance would help to reduce this, if the foundations are embedded sufficiently into the ground.

Further studies have been identified to improve knowledge:

- Sub-typologies;
- Incorporating soil structure interaction within the LS-DYNA non-linear time-history analyses and other non-linear models to test sensitivity and correlation with the linear models;
- Further refinement on specific building, foundation and subsoil conditions;
- Investigation into possible kinematic or foundation damping effects;
- Extend the area of investigation for soil type categorisation to the current study area; and
- Generation of site-specific ground response spectra.

4.3 Seismic Performance – Influence of Analysis Method

The following studies have been undertaken to explore the relative outcomes and therefore a quantitative comparison between different methodologies.

For this study, each of the methods, with the exception of the mechanism-based method which is not suitable, were deployed on typical building T3a. This typology is representative of the group of typologies of 2-storey residential buildings with the upper floor in the attic space.

A study was also undertaken on typical building T1* (an amended and more modern version of the T1 terraced house). The terraced house has been identified as being particularly vulnerable in the direction parallel to the front and rear façades (see Figure 17). For this study, the non-linear time-history analysis was carried out in addition to the modal response spectrum analysis using 2D elements.

Building T3a – Detached House

The building is relatively simple, with the seismic action assumed to be dominated by the first fundamental modes in each orthogonal direction. As a pre-requisite, it was assumed that sufficient ties exist to connect walls to floors and the roof, and that the diaphragms are made sufficiently stiff to distribute horizontal seismic load to walls acting in-plane. At the time of writing, all methodologies represented the foundation boundary condition with pin-supports. The findings are discussed below, commencing with the simplest and quickest and finishing with the most complex.

Building T1* – Terraced House

T1* is a simple 3-storey building. In the direction perpendicular to the front façade, the stability system comprises masonry party walls and gable end walls. In the orthogonal direction, masonry piers provide the stability system. As for T3a above, ties and stiff diaphragms have been assumed. T1* has been assessed with two methods, as described above.

4.3.1 Lateral force analysis

For T3a, it was possible to generate base shear forces and a distribution of these lateral forces between walls using the Lateral force analysis that were later proved to be only slightly more conservative but very close to those generated from the modal response spectrum analysis. Therefore, for low PGAs where linear methods are reasonably representative of building behaviour, this approach would be cost-efficient and effective. For T3a structural upgrading of walls was found to be necessary at PGA levels of approximately 0.1g.

4.3.2 Modal response spectrum analyses using equivalent frame elements

For T3a, the equivalent frame approach involved a modal response spectrum analysis using a combination of 1D beam and 2D shell elements to represent the building members.

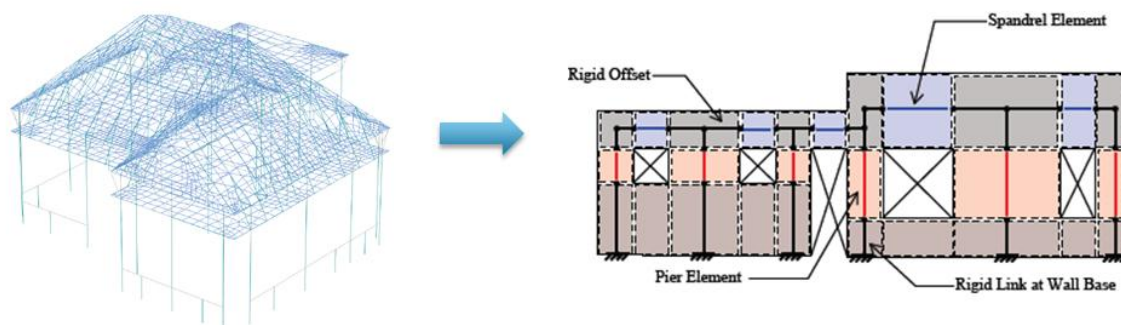

Figure 19 T3a - Equivalent frame pushover analysis model.

This analysis produced a slightly different load distribution between walls and individual piers (+/- 15-20%) compared to the more complex analyses below, but could be determined more quickly and efficiently and is no less valid, if properly calibrated. Overall outcomes in terms of anticipated structural upgrading of walls were found to be very similar to the 'base' method below. Therefore, for low PGAs, this method was found to be efficient and effective and would be more applicable compared to the lateral force analysis above when building complexity increases and seismic response is more influenced by higher modes.

Connection forces can be determined directly from the model. For T3a the model predicted that structural upgrading of walls may be necessary at PGA levels of approximately 0.1g.

4.3.3 Modal response spectrum analysis

Building T3a – Detached House

The modal response spectrum analysis was the 'base' methodology used in the study to date, and differs from the method above in that shell elements are used throughout to represent the masonry members.

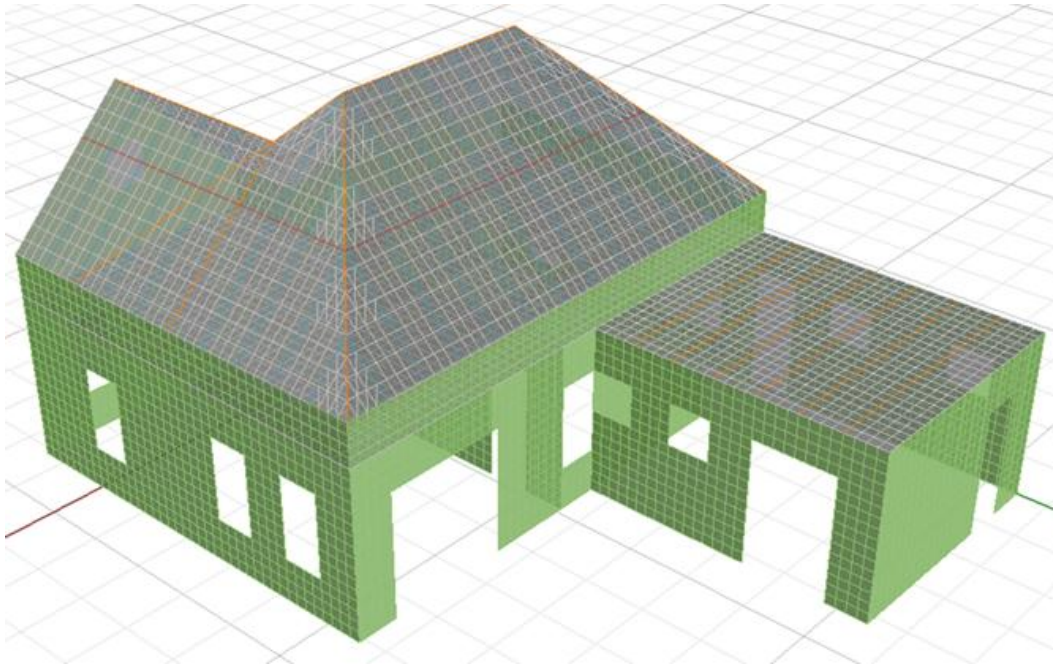

Figure 20 T3a - Linear dynamic analyses using 2D elements.

This resulted in a much larger model which took more time to analyse and much more time to extract data to determine connection forces, despite additional post-processors developed specifically to expedite the process.

The outcomes in terms of structural upgrading of walls were, overall, very similar to either of the above methods. This method was found to be appropriate for low PGAs and would be simpler to deploy on large scale within the industry with minimal training/education. For T3a the model predicts that structural upgrading of walls may be necessary at PGA levels of approximately 0.1g.

Building T1* – Terraced House

The studies using the modal response spectrum analyses suggest high over-utilisation ratios from even very low levels of PGA, which would require structural upgrading or replacement of walls needed at or below 0.05g. This is partially due to the inherent vulnerability of the building, but partly due to the limitations of a linear analysis on a typology that behaves very non-linearly.

4.3.4 Non-linear static pushover analysis using macro elements

This more sophisticated approach uses lumped plasticity to represent the non-linear behaviour of masonry. This has been based upon the non-linear static analysis procedures as defined in ASCE 41-13 along with the non-linear procedure acceptance criteria for in-plane action of URM walls in the same document.

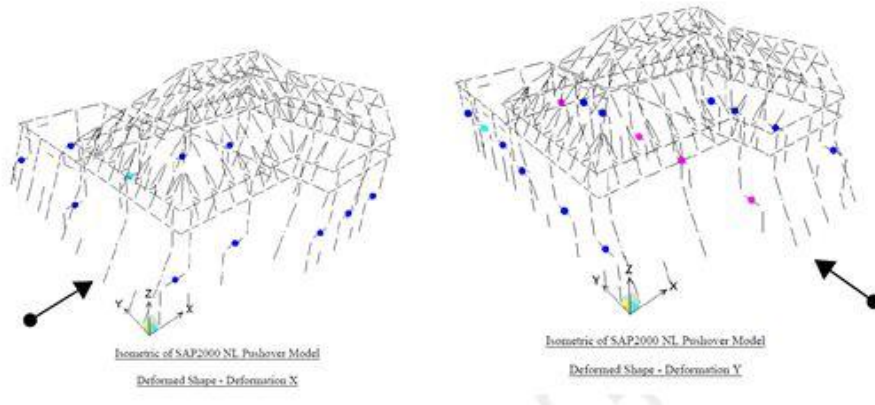

Figure 21 T3a - Non-linear Pushover analysis model.

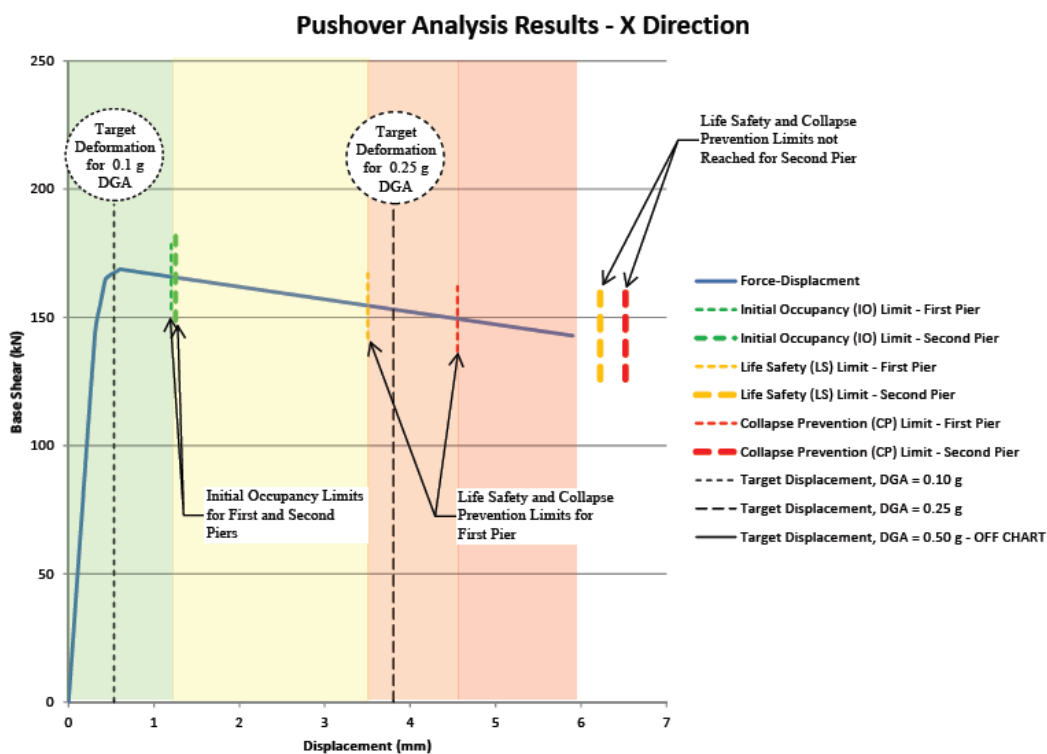

Figure 22 T3a - Non-linear Pushover analysis model – example for one of the models.

This methodology produced less conservative outcomes than any of the linear models in terms of structural upgrading of wall requirements as it takes into account the effects of non-linear behaviour. Structural upgrading of walls was found to be necessary from PGAs between 0.16g and 0.24g. Development of this methodology is work-in-progress at the time of writing and further verification and checking is required to calibrate the model.

Alternative methods are more appropriate for determination of connection forces – either hand calculations or parallel linear analyses using a similar model.

The results are encouraging and worthy of further exploration as initial findings suggest this may be the most suitable approach for the 2-3 storey individual masonry buildings. This methodology is common practice in the engineering community in the Netherlands, so deployment on any significant scale will require a programme of training and development.

4.3.5 Non-linear time-history analysis

Building T3a – Detached House

At the most complex end of the spectrum, the non-linear time-history analysis was used to determine the most accurate modelling methodology currently available. This method represents a significant step up in complexity and the time required to undertake an analysis, and involves the modelling of individual brick units and the contact conditions between them. In due course, this approach would also need to be verified against test data to be relied upon.

Two suites of input ground motions (each comprising three 3-component motions) were developed, comprising short and long duration motions, as noted in Section 2.4.1.2 and the model was analysed for these scenarios. The results for the shorter duration motions are more representative of expected ground motions in Groningen; the longer duration motions were also assessed for comparison, to isolate the effect of duration on structural response. Both suites of ground motions were spectrally matched to the target design spectrum, and then scaled to different levels of PGA: 0.1g, 0.25g, 0.5g and 0.9g.

The T1* model was also analysed at intermediate levels of PGA to determine with more precision the level of PGA leading to partial collapse.

“Partial collapse” (equivalent to DS4 in Table 2) was determined to occur when sections of walls or lintels dislodged in the analysis model and created a falling hazard. “Collapse” (equivalent to DS5 in Table 2) was determined to occur when significant portions of the roof were left unsupported by failing walls in the model, and fell to the ground. Crack widths were also measured from the model based on relative movement of bricks in the model, and in some cases crack widths of over 100 mm were observed in the model without partial collapse or collapse.

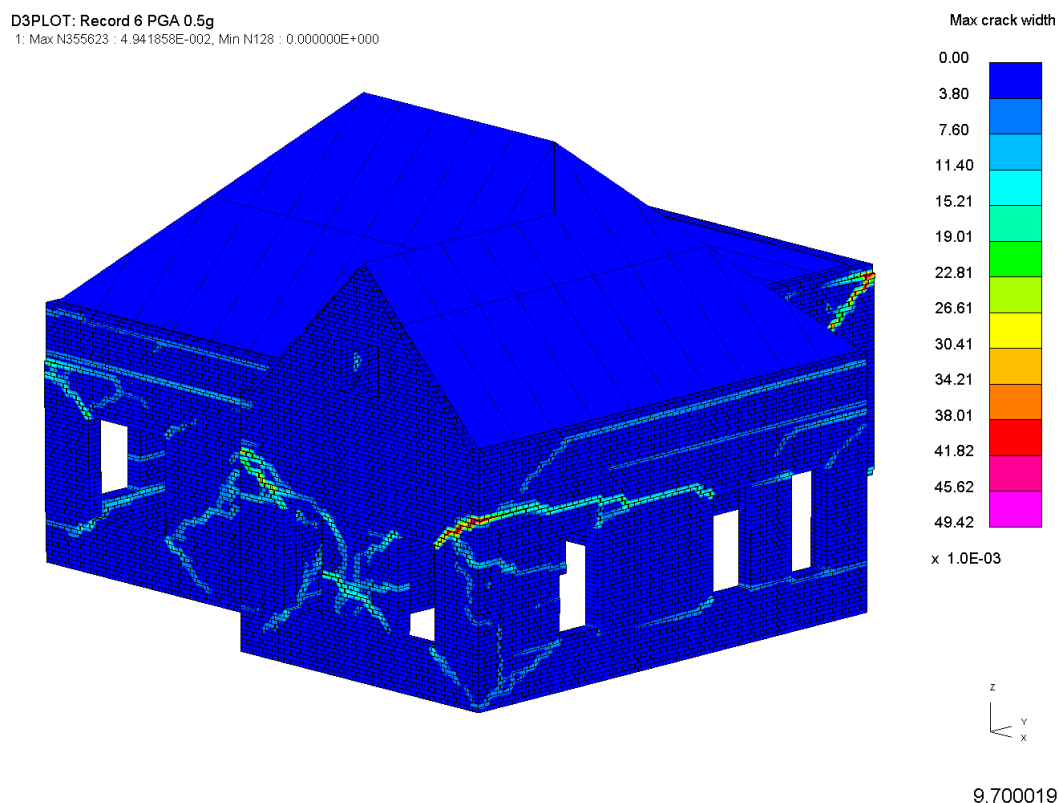

Figure 23 T3a – LS-DYNA model showing cracking during 0.5g short duration ground motion (in metres).

The building was analysed at 0.25g, 0.5g and 0.9g with short and long duration ground motions. Pier rocking and bed joint sliding mechanisms were observed in the model. Mixed modes were also observed where a sequence of mechanisms occur e.g. toe crushing or diagonal tension after rocking initiates.

Partial collapse was observed at a PGA of 0.9g short and long duration ground motions and was not observed in the 0.5g ground motions, indicating that the PGA required to cause partial collapse lies between those two values. Significant crack widths were observed in the 0.5g ground motions and longer-duration signals produced more damage than short-duration motions. Because intermediate levels of PGA were not analysed, it is not possible to observe a quantitative difference in partial collapse or collapse PGA for T3a for short and long duration motions.

Building T1* – Terraced House

The building was analysed at 0.25g, 0.5g and 0.9g with short and long duration ground motions, as well as intermediate levels of acceleration to identify PGA causing partial collapse (to the nearest 0.05g). Based on these analyses, the building is predicted to reach partial collapse at PGA of 0.3g based on collapse of the second storey outer leaf of the cavity wall. Collapse occurred at a PGA of 0.4g.

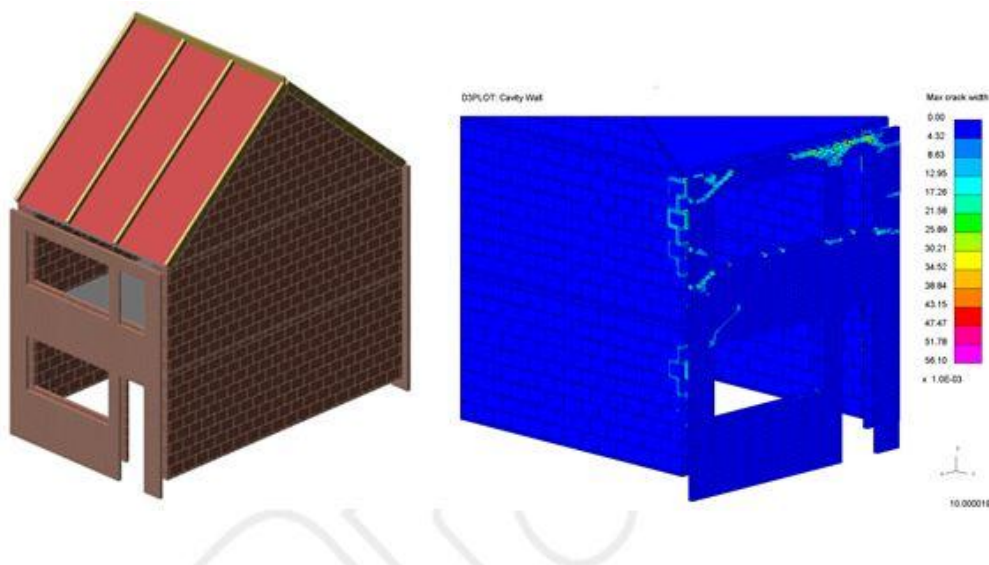

Figure 24 T1 – LS-DYNA model and cracking patterns.

Clearly there is a significant difference in outcomes between the modal response spectrum analysis and the non-linear time history analysis. The limitations of the ASCE and the LS-DYNA software package are discussed below. A further study using the non-linear pushover analysis is planned to test for sensitivity and appropriateness.

4.3.6 Discussion

4.3.6.1 Influence of analysis methodology

Table 12 below illustrates difference in outcome for the anticipated threshold for the structural upgrading of walls for typical building T3a and T1* based on the different analysis methodologies used. The linear methods all suggested that structural upgrading of walls may be required at PGAs of approximately 0.1g (for T1* even <0.05g). Changing to the non-linear push over method, this threshold increased to a value between 0.16g and 0.24g. Adopting the much more sophisticated non-linear dynamic time-history analysis using LS-DYNA, the threshold increased to 0.5g (for T1* 0.3g). The building behaves non-linearly and therefore is more accurately represented by the non-linear methodologies.

Table 12 Threshold for wall upgrading requirements

Analysis Methodology	Section	Approximate Threshold (T3a)	Approximate Threshold (T1*)
Lateral Force Analysis	4.3.1	0.1g	
Modal Response Spectrum Analysis - Equivalent Frame	4.3.2	0.1g	
Modal Response Spectrum Analysis	4.3.3	0.1g	<0.05g
Non-linear pushover analysis - Macro Elements	4.3.4	0.16g – 0.24g	
Non-linear time-history analysis	4.3.5	0.5g	0.3g

There are several methodologies available to assess the seismic response of a building, and some methods are more suitable than others for a given context. The initial findings have been highlighted below. Additionally, there is a range of methods available for a given building, commencing with a simple and quick method. In the event that the simple method yields unfavourable outcomes, the next level of complexity can be employed and so on until an adequate balance of assessment effort (or cost) to outcome is achieved.

Some of the primary considerations have been outlined below:

Table 13 Proposed implementation of different analysis methodologies

Analysis Methodology	Proposed Implementation
Linear methods generally	Linear methods at low levels of PGA as accuracy is less affected by structural and material non-linearity. Speed of assessment is therefore improved. Linear methods would also be an efficient methodology in the future once ductility factors have been derived for buildings specifically related to the Groningen region.
Lateral Force Analysis	Straightforward buildings, where load paths are clear and behaviour is governed by fundamental modes. Simple single-storey utility buildings where immediate occupancy performance level is required.
Modal Response Spectrum Analyses using Equivalent Frame Elements	Buildings with load-bearing piers linked by spandrel elements and dominated by fundamental modes.
Modal Response Spectrum Analysis	Complex building geometries, particularly where there are discontinuities of stiffness and geometry.
Non-Linear Pushover Analysis using Macro Elements	Buildings with load-bearing piers linked by spandrel elements and dominated by fundamental modes.

Non-Linear Pushover Analyses using Mechanism-based Elements	<p>Monumental-type structures such as churches and towers with massive masonry construction to model specific in and out-of-plane collapse mechanisms.</p> <p>This is particularly useful where pre-existing cracks and planes of weakness could precipitate failure.</p>
Non-Linear Time-History Analysis	<p>Buildings of special importance or value, where the investment in analysis and assessment time is justified.</p> <p>Large populations of identical buildings where the benefit of rigorous and specific analyses has a wider application.</p> <p>Validation of other, simpler models.</p> <p>Calibration with physical test data.</p>

In general, it has been found that at higher levels of PGA, non-linear models provide a more accurate representation of true building behaviour. Therefore, the selection of methodology for a particular building should take into consideration both the typology and the level of ground acceleration anticipated.

4.3.6.2 Representativeness of studied buildings

The results in Table 12 represent the findings on a typical fictitious building, and therefore a single data point for anticipated upgrading measures. Actual buildings within a single typology may have more or less-favourable arrangements of structural elements.

In order to investigate this, a sample of 100 buildings in Loppersum was studied to determine the variance of two geometric parameters (see Figure 25) defining the openness of the front façades. Figure 26 and Figure 27 represent the spread of data points for terraced and semi-detached buildings respectively. The size of the circles represent the age of the buildings (larger circles are older buildings, smaller circles newer buildings). High ratios of $A_{\text{wall}}/A_{\text{tot}}$ and $L_{\text{wall}}/L_{\text{tot}}$ represent less porous and therefore more favourable structural arrangements. The positions of the fictitious buildings studied has also been plotted for comparison with the sample data set. As seismic resistance of a wall is expected to be a function of openness, clearly some actual buildings within a given typology can be expected to have a greater structural resistance than those studied, whereas other actual buildings can be expected to be more vulnerable.

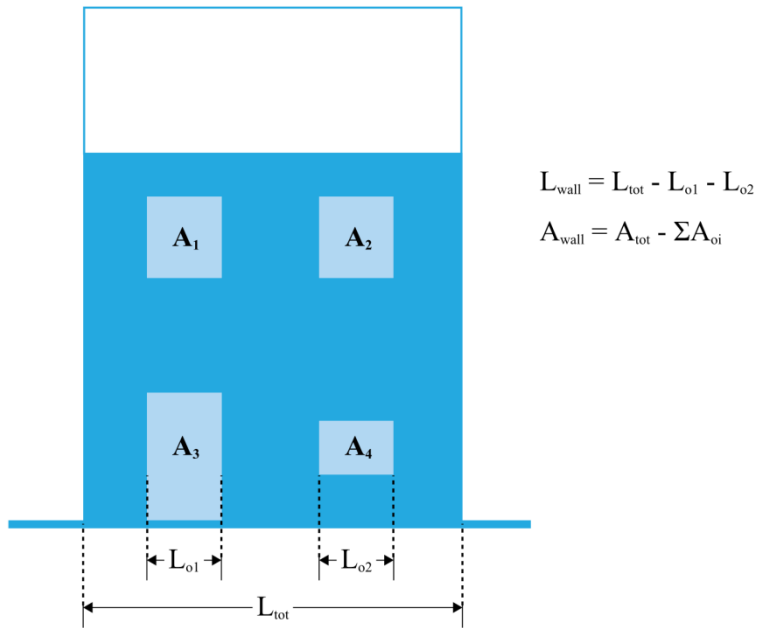

Figure 25 Definition of elevational openness

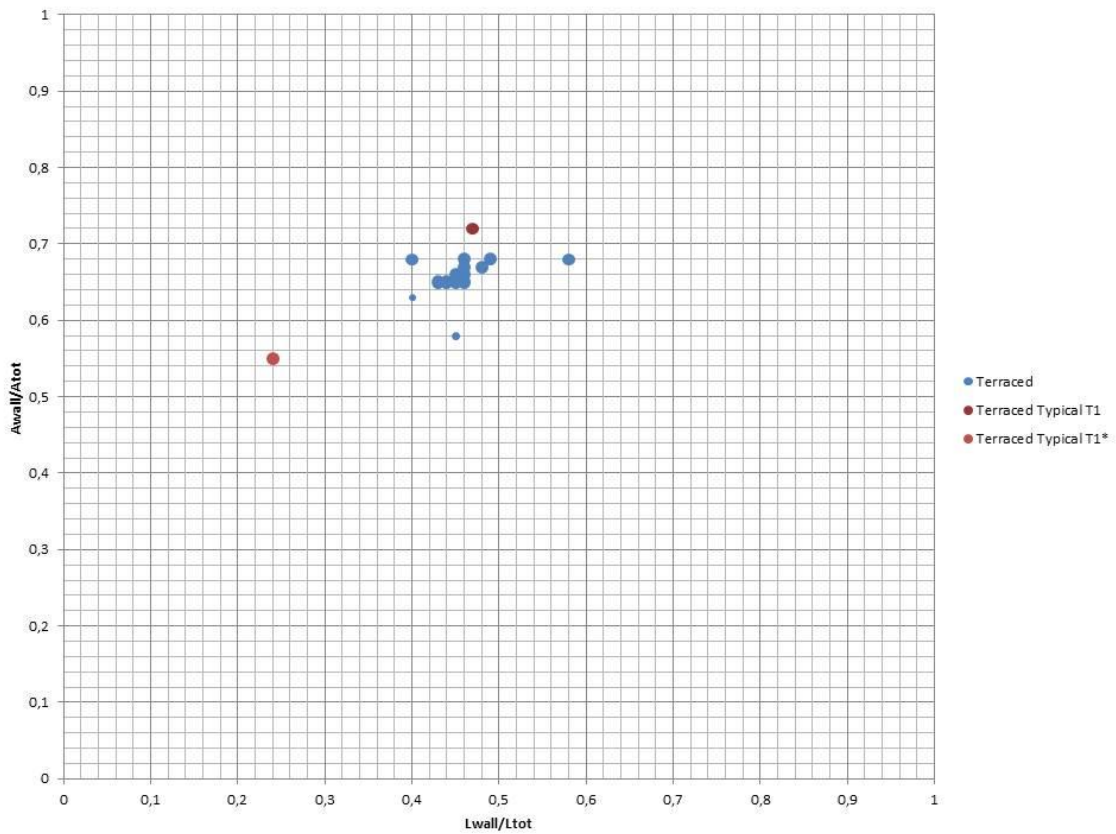

Figure 26 Façade openness data terraced buildings in Loppersum sample

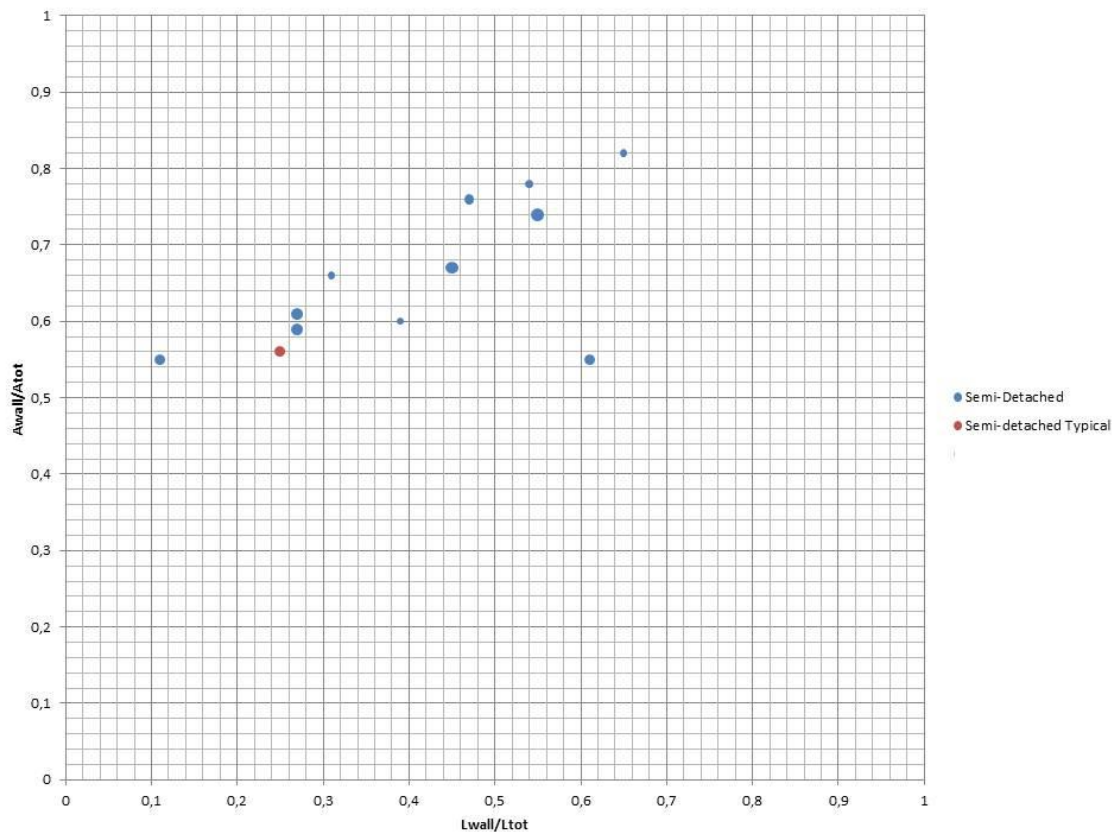

Figure 27 Façade openness data semi-detached buildings in Loppersum sample

4.4 Structural Upgrading Measures

There are many methods of structural upgrading. The aim is to establish effective and efficient measures taking the following factors into account:

- Expected seismic deficiencies in existing building stock;
- Applicability to local construction;
- Architectural impact;
- Disturbance to home owners and/or business continuity;
- Standardization possibilities;
- Speed of implementation; and
- Costs.

Appendix B gives a general overview of strategies to improve structural performance.

A number of representative buildings have been assessed for their seismic capacity and the upgrading measures that may be required to achieve adequate levels of resistance for different PGA levels. The buildings have been assessed using the linear dynamic analysis methodology for PGA's of 0.25g. Estimated interventions for other PGA's have been extrapolated from these preliminary results.

4.4.1 Non-Structural Elements

Many buildings have very slender internal walls, non-loadbearing in many cases, just half a brick thick. For PGAs above a certain threshold (to be determined) these walls will need to either be strengthened or replaced to avoid risk of collapse. Similarly, tall, slender furniture elements, such as bookshelves will need to be restrained or tied back.

- **Furniture and lightweight partitions:** To prevent lightweight partitions and furniture falling over, elements with heights over 1.3 metres and a height-to-depth or height-to width ratio greater than 3-to-1 shall be anchored to the floor slab or adjacent structural walls.
- **Chimneys and parapets:** Past earthquakes have consistently shown that unreinforced masonry chimneys and parapets are the first elements to fail in seismic events. Mitigation of these hazards can be achieved by either bracing them with steel angles or demolition and reconstruction with lightweight alternatives (see Section 4.4.2.1).
- **Deteriorated mortar:** URM walls where the mortar has severely deteriorated need repointing prior to the commencement of structural upgrading works.
- **Roof tiles:** Special attention should be given to roofs using concrete and clay roof tiles as they might fall off the roof during seismic events. Therefore the tiles should be secured by mechanical fastening and/or installation of snow guard fences, with frequency depending on roof pitch and layout.

This measure should as well be considered to be introduced to the immediate short-term measures to upgrade the existing buildings' safety.



Figure 28 Roof tile connection failure during the Roermond earthquake, Netherlands 1992.



Figure 29 Examples of mechanical tile fasteners.



Figure 30 Snow guard rails to capture loose tiles.

4.4.2 Intervention levels

The nature of the structural upgrading measures needed has been characterised into a number of intervention levels. Commencing at level 1, the intervention levels have been set out in order of the most cost-effective solutions that can be deployed most rapidly to reduce risk most quickly. There is a step change in cost/time/complexity between one level of intervention and the next.

Levels 1 to 3 can be considered as ‘lighter’ interventions, whereas Levels 4 onwards can be considered as ‘stronger’ interventions.

Permanent upgrading measures – intervention levels:

- **Level 1:** Mitigation measures for reducing higher risk building elements (potential falling hazards);
- **Level 2:** Tying of floors and walls (and checking/installing/replacing wall ties);
- **Level 3:** Stiffening of flexible diaphragms;
- **Level 4:** Strengthening of existing walls;
- **Level 5:** Replacement and addition of walls;
- **Level 6:** Foundation strengthening; and
- **Level 7:** Demolition.

Temporary upgrading measures will be implemented for specific building types for quick risk reduction, for example terraced houses; semi-detached houses, shop front buildings etc.

4.4.2.1 Permanent level 1: structural upgrading of falling hazards

Level 1 intervention greatly reduces the immediate risk of falling elements starting at potentially low level of ground acceleration. The risks can be assessed rapidly and simple, cost-efficient measures can be implemented to stabilise vulnerable elements. The implementation of level 1 intervention is already under way as part of the Pilot 2 programme.

Examples are given in Figure 31 and Figure 32. These are primarily external interventions resulting in limited disturbance to occupants.



Figure 31 Parapet restraint.



Figure 32 Chimney Restraint

4.4.2.2 Permanent level 2: tying of floors and walls

Ensuring that principal building components are adequately tied together is the most effective means to enhance seismic capacity by improving overall building robustness. Tying walls to floor and roof diaphragms prevents walls from collapsing and substantially increases the ability of the walls to resist out-of-plane seismic forces.

Positive connection to floor and roof diaphragms allows the diaphragms to transfer and distribute the seismic forces to the load-resisting structural elements

Tying requirements are relatively quick to establish detail and implement with minimal impact on occupants. It is still necessary to enter the house, remove ceilings etc. They are a very cost-effective means to improve seismic response.

Experience with past earthquakes in other countries highlights the vulnerability of the outer leaf of cavity wall masonry where cavity wall ties have corroded. The integrity and presence of cavity wall ties should be inspected with a boroscope and, if inadequate, replacement or additional wall ties installed (see Figures 33 and Figure 34).

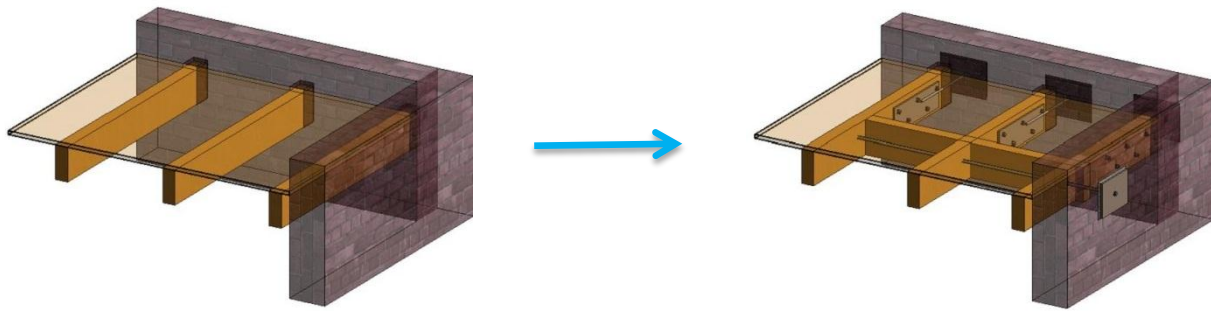

Figure 33 Positive mechanical tying of walls to floors and roofs

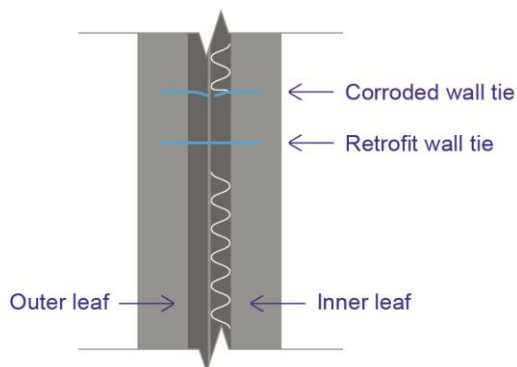

Figure 34 Replacement of corroded cavity wall ties

4.4.2.3 Permanent level 3: stiffening of flexible diaphragms

Once walls have been tied to diaphragms, the next most effective level of intervention is to ensure that the diaphragms have sufficient stiffness to transfer load in-plane to walls, acting in their strong, in-plane, direction. This intervention improves the overall building capacity by ensuring box-like action.

Depending on the specific building, diaphragm stiffening could be as straightforward as adding another layer of planks and joist stiffeners, or could involve steel transfer frames and braces if diaphragms are discontinuous.

This level of intervention is a step change up from level 2 and will require temporary relocation of the building inhabitants.

Where feasible, undertaking level 3 interventions on a given building simultaneously with level 2 would clearly be more economical and reduce disruption to occupants as both are internal construction activities.

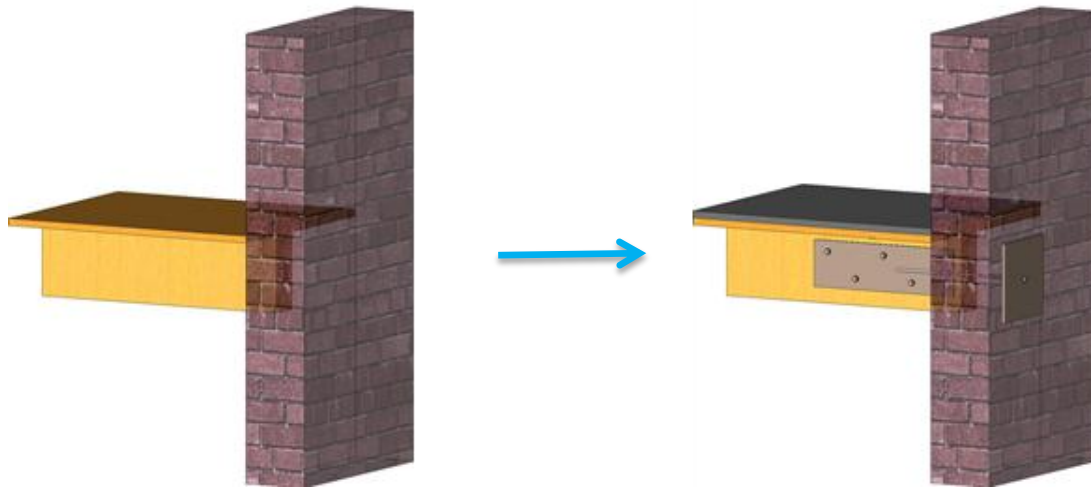

Figure 35 Stiffening of diaphragms and connection to walls

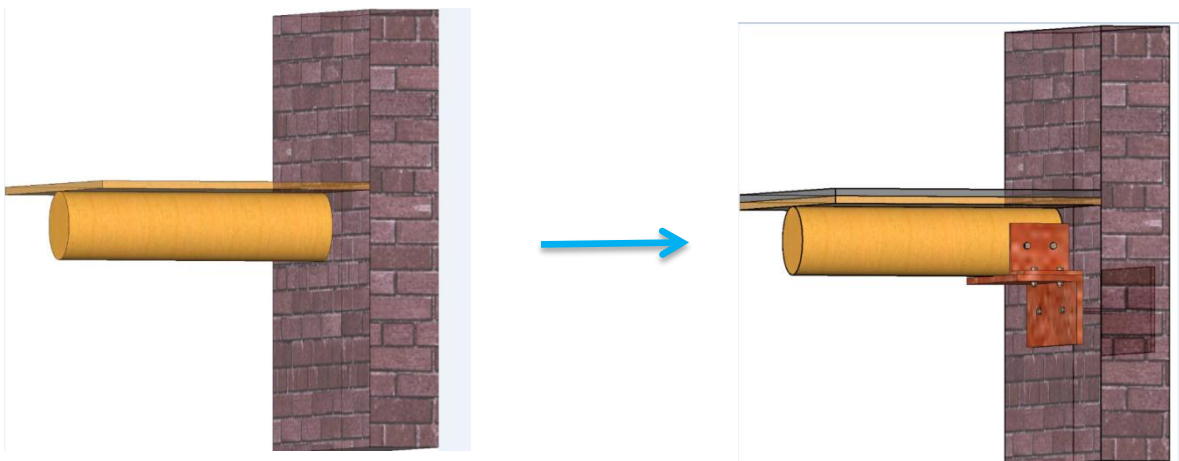

Figure 36 Stiffening of diaphragms and connections to walls

4.4.2.4 Permanent level 4: strengthening of existing walls

With an adequately tied building with stiff diaphragms, the seismic forces are distributed to the walls in a favourable manner. In the in-plane direction, if the capacity of the unreinforced masonry is exceeded, the strength of the wall must be supplemented. There are many ways of achieving this and for the purposes of the concept design, the selected solution was carbon fibre-reinforced polymer (CFRP) bonded to the face of the masonry Figure 37. This applies to internal and external walls. This provides a tension-resisting mechanism, thereby increasing the bending and shear capacity of masonry piers and spandrels. CFRP has been used to test feasibility as it has both high strength and low mass. There are numerous other similar solutions using bonded fibres and bars that will be explored in due course as part of a cost-benefit process. There are also proprietary systems such as the CAM system, common in Italy that utilises tensioned metal, straps that will also be investigated.

Wall strengthening of this nature requires access both internally and externally and therefore temporary relocation of inhabitants and furniture, and removal and re-application of wall finishes after application, both inside and on the outside of the building, changing the appearance of the building.

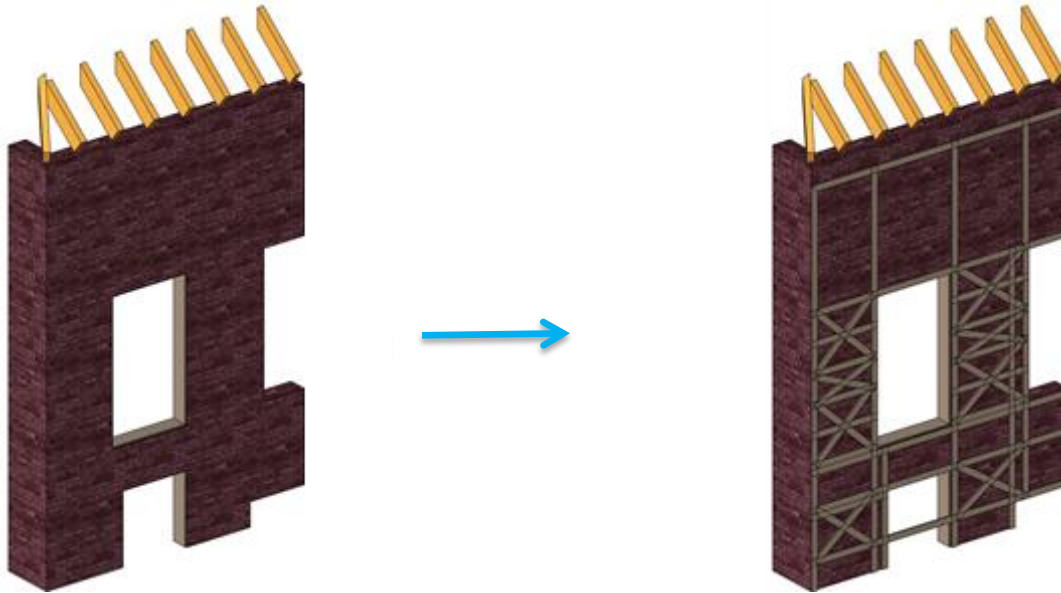

Figure 37 Addition of material to increase strength of masonry wall piers/spandrels.

Shotcrete or concrete overlays (see Figure 38) can be used to supplement both the in-plane and out-of-plane strength. This is the proposed solution for the utility buildings where the intervention can be carried out from outside the building, thereby avoiding disrupting business continuity.

Figure 39 below shows an alternative using a system of internal mullions to provide the capability to span out-of-plane. This solution has been proposed for the agricultural buildings where the loss in usable space and interior aesthetics has been deemed less important and a lower-cost solution may be more appropriate.

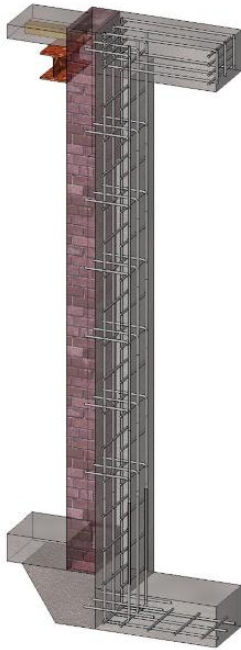

Figure 38 Reinforced concrete overlay

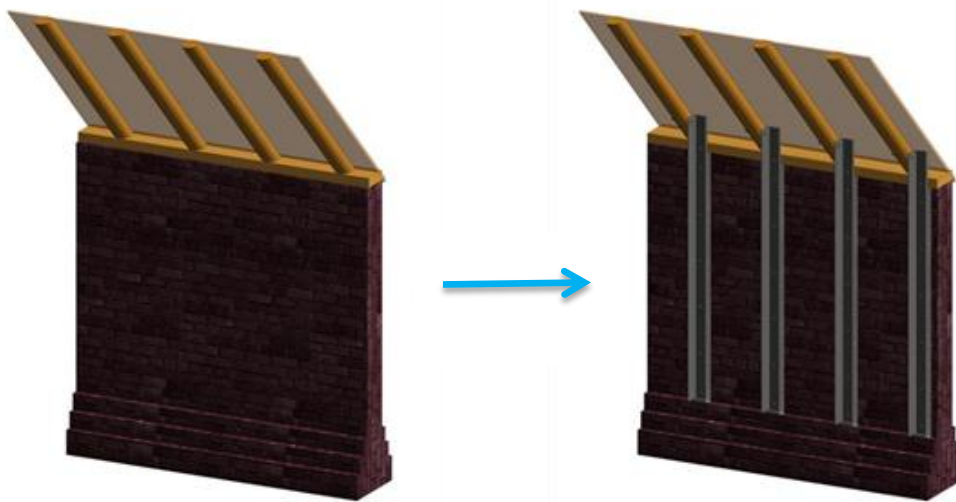

Figure 39 Addition of structural elements to increase in-plane and/or out-of-plane strength of wall piers.

4.4.2.5 Permanent level 5: replacement and addition of walls

If strengthening of walls is no longer cost-effective, URM walls can be replaced by structural systems with greater strength and/or ductility.



Figure 40 Replacing existing masonry walls with reinforced concrete walls.

Where an inadequate arrangement of shear walls exist, supplementary shear walls could be added to improve the overall distribution of seismic loads, as shown in Figure 41 below. Sufficient foundations must exist to support new shear walls, which may require the installation of additional foundation systems.

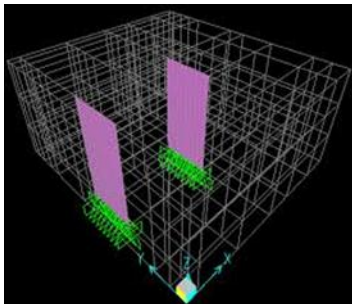

Figure 41 Additional reinforced concrete shear walls

For some terraced and semi-detached buildings where the strength in one direction is particularly low, façade panels could be replaced by systems that have adequate structural capacity.

Clearly, this level of intervention may require extensive disruption and cost, and probably temporary relocation of inhabitants or discontinuity of building function.

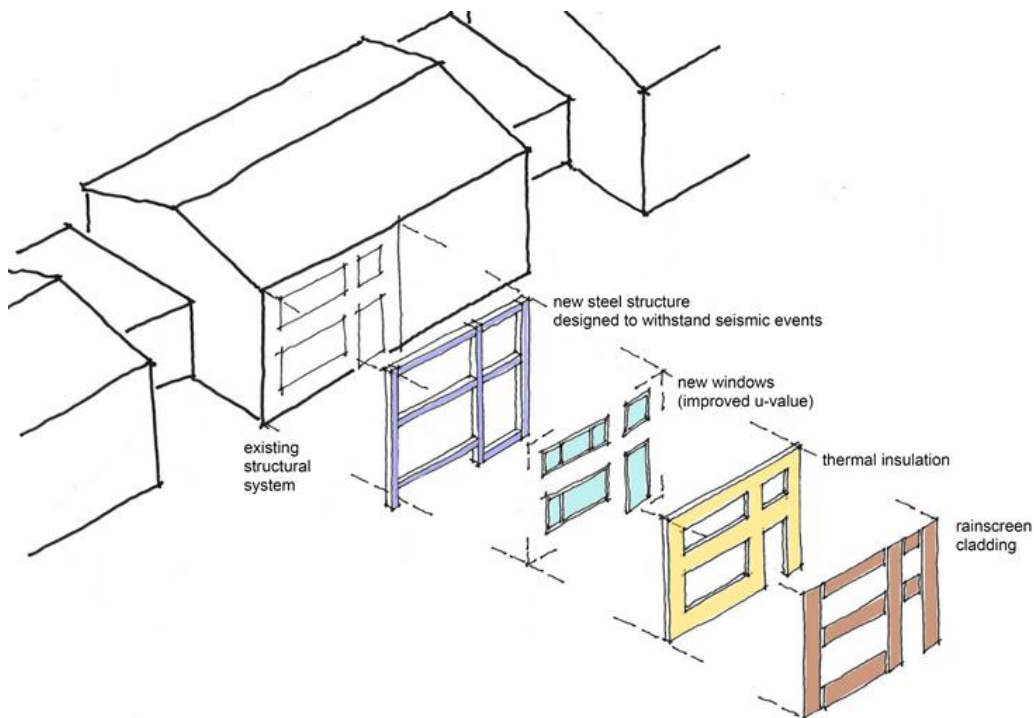

Figure 42 Replacement (façade) walls.

4.4.2.6 Permanent level 6: foundation strengthening

Where the seismic loads on the building exceed the capacity of either the existing foundation system and/or ultimate capacity of the soil, foundation enlargement or strengthening may be required. At high PGA levels, there is potential for elements of some building typologies to slide off the foundations. Therefore they will need to be adequately connected.

Where overturning bending moments on piers need to transmit a net tension to the foundation system, the piers, or tension-resisting component of the piers, will need to be anchored and tied down to the foundation.

Clearly, this level of intervention may require extensive disruption and cost, and probably temporary relocation of inhabitants or loss of business continuity.

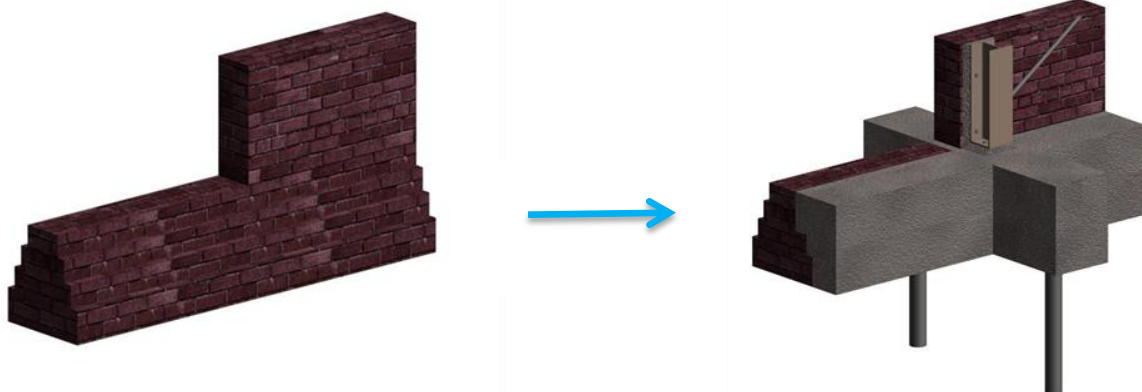

Figure 43 Increasing strength and/or stiffness of existing foundation system.

4.4.2.7 Temporary strengthening measures

Some building typologies are particularly vulnerable to ground motion in a specific direction. For example, some terraced and semi-detached buildings have limited lateral load-resisting structural systems in the direction parallel to the front and rear façades.

In order to reduce the vulnerability of these buildings, temporary measures can be deployed quickly and effectively to reduce the risk of collapse until permanent solutions can be implemented. For example, ‘book-end’ frames can provide a seismic load path in the longitudinal direction, which will increase the PGA threshold at which seismic effects cause the buildings to be at risk. These can be further supplemented by waling beams, braces and transverse frames to provide additional diaphragm capacity and transverse stability respectively.

Installation of strongbacks will prevent premature failure of masonry out-of-plane, thereby increasing the PGA threshold further.

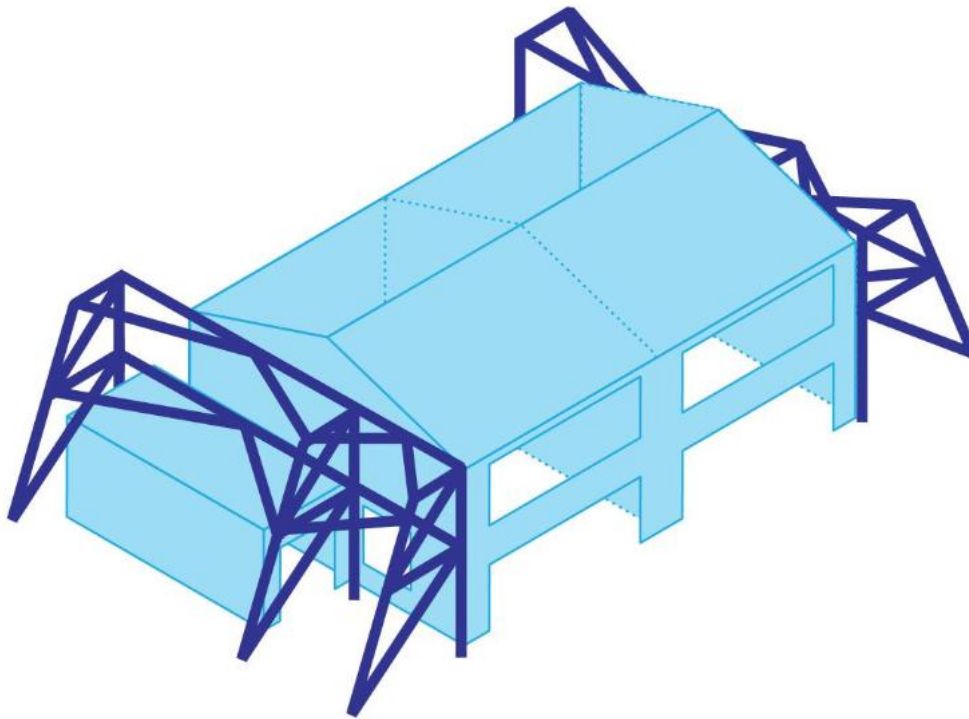

Figure 44 Temporary steel “bookend” frames

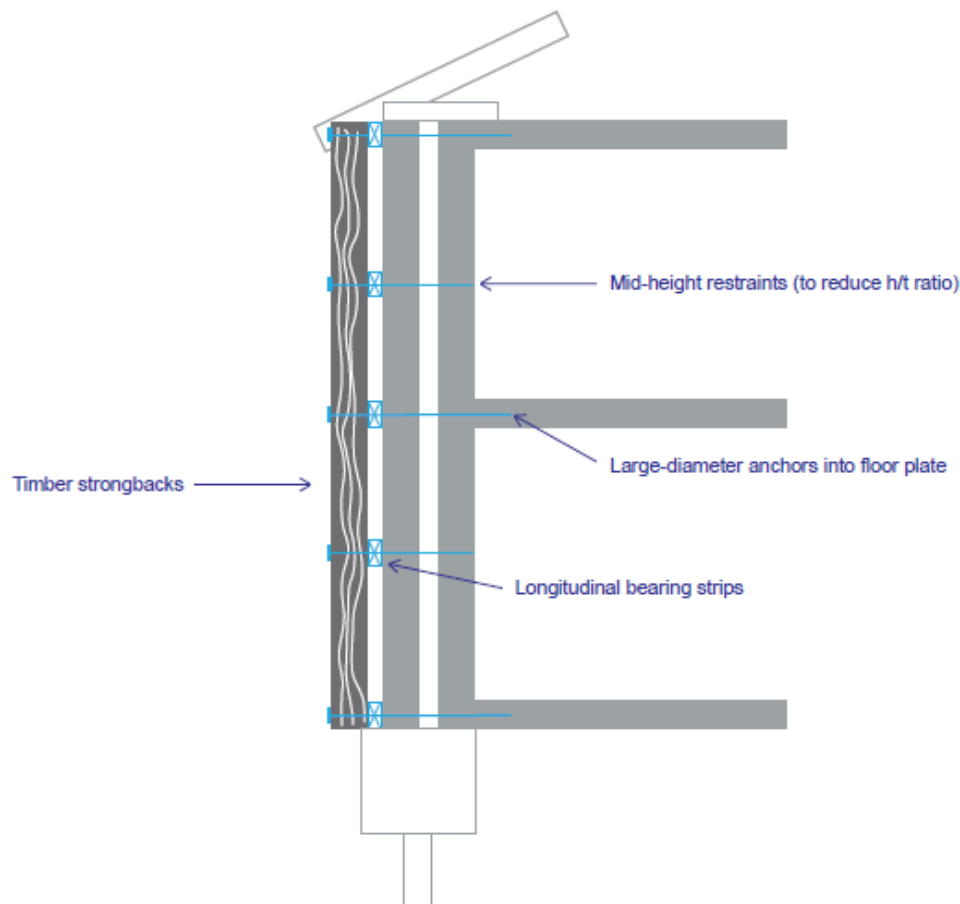

Figure 45 Temporary strongback system.

4.4.3 Post-upgrading seismic evaluation

Strengthening measures have the potential to alter the behaviour of the building under seismic action. Upgrades may affect the building mass, stiffness, ductility and load paths. Consequently, the seismic response and distribution of demands on the resulting structure may change.

The buildings investigated have, therefore, all been assessed and checked for their behaviour and capacity after retrofit interventions. This is often an iterative process whereby the effects of interventions are assessed until convergence has been achieved.

The exceptions are typologies T1 and T2, which require substantial structural upgrading at higher PGAs, whether temporary or permanent, in the most vulnerable direction. Concept solutions have been proposed which require further dialogue and development.

4.4.4 Applicability of interventions

Structural upgrading measures have been developed for the buildings for a PGA of 0.25g.

However, the scope of applicability of these structural upgrading measures could be extended to higher hazard levels if some uncertainties can be reduced.

- If the performance objective is subsequently set such that the return period for existing buildings compared to new buildings can be altered, this might result in a reduced seismic demand for existing buildings. 67% is not unreasonable based on precedents in other countries such as New Zealand.
- On the capacity side, a knowledge factor of 0.75 has been used at present. If sufficient knowledge is subsequently gained through testing, this can be improved to a value of 1.0.

Combining refinements to both the demand and capacity sides in this way, retrofit solutions for superstructure elements developed for 0.25g could also be applicable to buildings until the 0.5g hazard contour ($0.5g \times 0.67 \times 0.75 = 0.25g$).

There are many uncertainties on both the seismic hazard and structural capacity estimates, as set out in Section 5. Uncertainties are too large at this stage for making reasonable and defensible decision in traditional way regarding number/level of interventions.

Foundation capacities are highly dependent on the specific soil capacity, foundation size and foundation embedment depths. Studies to date indicate that foundations in general may be close to or above ultimate capacity at PGAs of approximately 0.25g, but this requires further evaluation.

It will not be possible, within the capacity of the construction industry, to undertake all required interventions simultaneously. The Implementation Study sets out a procedure for prioritising the reduction of the highest risks as part of a stepped approach. Two separate work streams have been distinguished for *normal* (Importance Classes I and II) and *important* (Importance Classes III and IV) buildings respectively:

- **Work stream 1** has commenced with a process of Rapid Visual Screening (RVS) to mitigate high-level risks (falling hazards) in accordance with the FEMA 154, modified for the local situation. Step 2 will involve the tying of walls to floors and roofs to improve structural robustness, if necessary. Step 3 will then capture other measures if necessary. Each step will commence with a pilot (Pilot 2) to test the feasibility of execution of measures; and
- **Work stream 2** will require a more tailored, individual approach to specific buildings.

4.5 Duration Studies

The current findings from the duration studies are as follows:

Ground motion duration is known to scale with earthquake magnitude. The hazard analysis carried out by Shell identifies a disaggregated scenario of M4.2 to M4.7. Therefore, it is expected that for $PGA > 0.5g$, ground motions would be associated with very short durations compared to earthquakes typically considered for seismic design, where magnitude may range from 5.5 to 8. The current investigations have not yet fully identified the characteristics of the durations.

Structural response of masonry is known to be duration-dependent and understood to significantly affect damage states. This is not taken into account by any codes for design or assessment of masonry structures, and no quantitative guidance is currently available. The response of 3D FEM models incorporating a time-history signal to date (T3a and T1) indicate approximately a 10% benefit in collapse capacity for short-duration signals compared to those more typically associated with longer-duration events.

The statistical effects on building fragility using simplified representation of 3D models indicate a maximum of approximately 20% improvement in the collapse capacity relative to longer durations. This study is documented in Appendix C of the Seismic Risk Study. The Pinho and Crowley paper (2013) on statistical effect on fragility indicates a maximum improvement of approximately 60%. Both the Arup and Pinho and Crowley studies are based on limited data sets.

Preliminary studies on cavity walls and solid walls have been undertaken to assess out-of-plane response and its dependence on duration (see Section 4.2.1). They also show some benefit in accounting for shorter duration.

5 Uncertainties and Uncertainty Reduction

The purpose of this section is to highlight and discuss the range of uncertainties in the study and propose means to reduce the uncertainty by further studies.

5.1 Uncertainties

5.1.1 Approach to uncertainty

In the design of new buildings, seismic resistant design can often be incorporated at a cost premium of less than 5–10% of the building costs, depending on the level of seismic hazard and code requirements. Provided design codes and seismic hazard maps are calibrated correctly, this can be a relatively small cost for the sake of significantly reducing seismic risk to occupants.

For existing buildings, the biggest cost (premium can be associated with the) decision is whether retrofit is required or not. Furthermore, increasing levels of seismic hazard can mean more and more invasive retrofit requirements. Associated costs could be of the order of 20–100% of the building value, depending on the specific requirements. Indirect costs are also attracted, as are the issues of social acceptability: relocation, temporary measures and construction activity in domestic areas. In this case, the same level of risk reduction to building occupants may not be justified for the large costs.

Therefore, there is significant benefit for existing buildings in reducing any overhead in the seismic assessment due to conservatism introduced to account for uncertainties. Given the large number of buildings potentially affected, uncertainty reduction is of key importance.

5.1.2 Seismic action model uncertainties

5.1.2.1 Interpretation of Probabilistic Seismic Hazard Analysis (PSHA) results

There are several items relating to the interpretation of results from the PSHA that would affect the value of PGA used in the structural upgrading work.

There are a number of uncertainties associated with the PSHA analysis, as discussed in Seismic Risk Study – Earth quake Scenario-Based Risk Assessment. These uncertainties affect mainly the overall level of expected PGA across the whole field, and not its distribution; i.e. the contours of seismic hazard are not expected to change much in shape, just in value. The partitioning factor has a wide range of possible values and this assumption has a significant influence on the seismic hazard level. This is expected to decrease over time as more sub-soil information becomes available.

5.1.2.2 Averaging period

The seismic hazard has been evaluated on an averaging period of ten years, starting from 2013. There is no precedent for interpretation of time-dependent hazard results in a Eurocode context, and the averaging period below was selected. Selection of the period 2013-2018, for example, would reduce the seismic action by an estimated 10-20%. Conversely, in increasing the averaging period to 20 years (2013-2033), the seismic action may increase by an estimated 10-20%, due to increasing hazard with production.

5.1.2.3 Ground motion Characteristics

Response spectral shape

The structural upgrading work has used a Eurocode 8 Type 2 Ground Type E design spectrum, anchored on the PGA from a seismic hazard assessment. There are two aspects of this that warrant further study:

Spectral shape for Groningen motions.

Deltares and TNO have investigated the spectral shape of the ground motions measured in the Groningen field to date^[6]. However, these have been recorded in induced earthquakes of up to M3.6, and spectral shape is expected to be very different for M4.7 or M5. The best estimate of expected response so far is using the Akkar et al (2013)^[6] ground motion prediction equation (GMPE) to plot a spectrum for the scenario event, conditioned on a level of PGA from the hazard assessment. On the basis of limited data, this GMPE has been validated as reasonable for PGA and PGV for Groningen ground motions for $M > 4$, but has been modified for smaller magnitudes. This GMPE needs to be studied for response spectral ordinates.

Site response analysis

Site response also affects the shape of the response spectrum. This is taken into account in the GMPE with a single parameter (V_{s30}), the average shear wave velocity in the top 30 m of soil), but since borehole data exists for the area, a site response effect can be evaluated for specific sites. This has already been undertaken as part of the Huizinge root causes study Arup, 2013a.

For specific buildings in a specific location, there is scope to use site-specific spectra to reduce conservatism. The diagrams in Appendix C show the EC8 spectrum and a 'best estimate' spectrum together with the significant modes plotted for each building. These give an indication of the potential benefit in refining the response spectrum in each case, if further study of the spectrum is carried out. However, the PSHA has been conducted for a particular assumption of uniform soil everywhere, and therefore properly taking this into account would also require modifying the surface PGA level as well as the spectral shape.

Duration of ground motions in Groningen

Ground motion duration is known to be very dependent on earthquake magnitude. Magnitudes of interest for this study are between M4.5 and M5. Typically, earthquakes of this relatively small magnitude do not cause significant amounts of damage to buildings, but in this case, due to the shallow depths or the induced earthquakes, PGA levels are relatively high. Therefore it is important to understand if the ground motion signals associated with these high accelerations are likely to be shorter than assumed in codes and guidelines for design and assessment of structures. If they are shorter, then studies on the duration-dependence of structural response (see Sections 4.5 and 5.2.2.2) are important.

Systematic studies have not been carried out on what durations are expected for a design seismic event in the Groningen region. However, initial indications are that ground motions from the 2012 Huizinge event were longer duration than expected for a M3.6 event. A problem with this conclusion is that it was based on a prediction equation for duration that was only calibrated for earthquakes of M5 or greater, and therefore the extrapolation is unreliable for smaller magnitudes. There are also many definitions of strong ground motion duration, and it is possible that the definition used (significant duration between 5% and 75% of Arias Intensity build-up) is not appropriate for the relatively small signals recorded in Huizinge. An alternative explanation is that ground motions in the Groningen field are indeed

longer than expected for such small magnitudes, and therefore the benefit of taking into account duration on structural response may be limited.

5.1.2.4 Soil conditions and foundations

Soil-structure interaction has not been taken into account in the initial studies. Flexibility of soil is expected to increase the overall vibration period of the buildings and therefore decrease the total forces that must be resisted. However, displacements in the buildings will increase which may lead to serviceability problems. The soil-structure interaction study has sought to determine a realistic range of effective foundation stiffnesses and how these can be represented in an analysis to capture the soil-structure interaction. These studies will inform the expected increase (range) in period for each typology; whether the significant modes would be affected, whether this would subsequently lead to reduced seismic demand and check foundation capacity. Refer to Section 4.2.2.

Liquefaction has been identified by Arup [Arup, (2013b) and Deltares (2013)^[16]] as a potential problem for soils in the area. This has not been taken into account in existing building assessment. This can sometimes have a positive effect of reducing loads (albeit not in a reliable enough way to justify no intervention), but it can also lead to differential settlements which can cause significant damage to buildings.

5.1.3 Seismic resistance

5.1.3.1 Analysis methodology

Response spectrum analysis has been used in general to model the response of the structures. Typically buildings of one to three storeys would be analysed using the simpler equivalent lateral force method of analysis, although this typically gives higher total forces. The response spectrum analysis method was carried out according to Eurocode 8. Response spectrum analysis is a linear method, and therefore where nonlinear response is expected and acceptable (such as for deformation-controlled actions in masonry walls), an approximate method is given in ASCE 41-13 to give the acceptable nonlinearity on the basis of scaled linear results (scaling by m factors, as noted above in Section 5.1.3.4).

Non-linear time-history analyses have also been carried out in LS-DYNA, and seem to show that there is conservatism in the modal response spectrum analyses with m factors, as one would expect. There could be several sources of conservatism in the simpler analyses with respect to the detailed analyses which are currently under investigation. Refer to Section 4.3.5.

Codes are typically set up to reward engineers carrying out more complex analyses by allowing less conservative assumptions. Similarly, complex analyses when adequately verified can be used to justify deviations from codes. Therefore, there is some expected quantitative benefit in adopting complex analyses. The different approaches have been discussed in Section 2.5 with preliminary findings captured in Section 4.3.

Codes are set up to provide rules that apply to generic buildings. Simpler, conservative approaches are more generically-applicable. More complex modelling approaches become more accurate at the expense of being more specific and narrow in their range of applicability.

Many of the building typologies and sub-typologies use cavity wall construction. The initial approach has been to model cavity walls as a solid wall, which over-estimates stiffness in the

analysis model. Alternative modelling approaches for cavity wall buildings have been investigated and discussed in Section 4.2.1.

5.1.3.2 Knowledge of buildings and materials

Conservative material assumptions have been adopted, as required by Eurocode 8 and ASCE 41-13 when building-specific material testing has not been carried out.

A knowledge factor of 0.75 has been adopted as required by ASCE 41. The equivalent factor in Eurocode 8 is a confidence factor, which is the reciprocal of knowledge factor, and we would require a value of 1.35 (i.e. a factor of $1/1.35 = 0.74$ on strength). Therefore there is no difference between the codes in this assumption. To increase this value to 1.0, a programme of testing in compliance with ASCE 41-13 and/or Eurocode 8 is required and has been recommended.

5.1.3.3 Effect of ground motion duration on structural response

Studies carried out to date on the effect of ground motion duration on the response of unreinforced masonry buildings in Groningen have indicated some benefit. This benefit is contingent on further studies to demonstrate that the ground motions are indeed expected to be short duration for the design seismic event.

Pinho and Crowley have provided a preliminary estimate of duration dependence of masonry response, which showed a 40-60% increase in the effective capacity of masonry structures when comparing short duration motions with long duration. This estimate was based on an initial literature review and limited analytical modelling. Shorter duration motions used were based on existing recordings from the 2012 Huizinge earthquake, and therefore may not be representative of a M4.5 to M5 earthquake. The analytical models were calibrated on test results from Italian masonry buildings and may need further calibration for Dutch buildings.

Arup carried out a similar study, as documented in Appendix C of the Seismic Risk Study. In that study, the collapse capacity showed a 20% improvement for shorter duration motions. Arup also considered the effect of duration in the cavity wall studies and time history analysis of T3a and T1 typical buildings, which showed a small benefit in accounting for shorter ground motion duration.

5.1.3.4 Ductility

A ductility factor accounts for the influence of the non-linear response of materials and structural system when used in a linear analysis.

ASCE 41-06 and 41-13 has been used for the in-plane assessment of masonry walls, as this represents the state of the art of masonry assessment. In particular, the ASCE 41 documents allow deformation-controlled actions in masonry piers (i.e. rocking and bed-joint sliding) to take loads of $m=3$ or more times the elastic capacities, whereas the equivalent factor in Eurocode 8 (q) is fixed at 1.5 for all actions (deformation-controlled and force-controlled) for masonry buildings. They are applied in different ways within the assessment and relate to different code approaches and could change significantly the results of the structural upgrading studies.

The effect of the ductility factor could improve the outcomes if higher values can be justified, particularly taking duration-related effects and possible physical test results into

consideration. The outcomes could be quite sensitive to the code adopted, however, and could also make outcomes more onerous pending NEN committee decisions.

5.1.3.5 Vulnerability

Threshold for intervention

The current estimates from the linear analyses suggest that buildings subjected to PGA's as low as 0.05-0.1g may need some form of strengthening. However, observations from earthquakes in other countries suggest that this threshold may be higher – in the order of 0.1-0.2g.

Representation accuracy by typology

A small sample representing a few building typologies have been investigated to date. For the Typical buildings in particular, there are many common variants of terraced and semi-detached buildings. The Typical buildings study has selected a variant in each case that represents relatively heavy structure (concrete floors) on stiff foundations (piles) with cavity walls. For the semi-detached buildings, a lightweight (timber) and solid wall variant was also investigated. These are expected to cause the unreinforced masonry components to work harder during an earthquake than variants with timber floors, on shallow foundations with solid walls, for example. However, there is a trade-off between the benefit of reduced seismic mass and the detrimental effect of reduced axial preload in the piers. It would therefore be overly conservative to extrapolate the retrofit interventions identified for one sub-typology across the whole population of buildings for that typology.

5.1.4 Target safety level uncertainties

5.1.4.1 New buildings

The target performance objective for new buildings of normal importance has been assumed to be Life Safety performance level with a 475-year return period for ground motion. Longer return periods would lead to higher accelerations and seismic forces.

For buildings of higher importance, importance factors of 1.2 and 1.4 are anticipated. Explicit performance-based objectives as set out in ASCE 41-13 have been used for upgrading measures– Life Safety performance level for the normal buildings and Immediate Occupancy performance level for the Utility Buildings. Where performance-based objectives are used to ASCE 41-13, the importance factors are set to unity to ensure consistency in the approach between codes.

5.1.4.2 Existing buildings

For assessment of existing buildings, there is precedent in international codes to consider shorter return periods and therefore lower seismic forces to take into account higher tolerable probabilities of failure for existing buildings when compared to new structures. This is in recognition of the fact that existing buildings have a shorter residual lifespan and have high cost for retrofits. Upgrading measures for existing buildings are assessed for between 33% and 100% of the accelerations compared to new buildings. Adopting a different return period will change both the level of acceleration, but also the scenario earthquake. Potentially, this could also lead to a change in duration.

Table 14 Seismic Action model uncertainties.

Influencing factor and sources of uncertainty	Currently assumed value	Likely direction when more data is obtained	Possible range	Influence on number and extent of interventions	Estimated time frame to reduce uncertainty	Within Arup scope of work
Epistemic uncertainties in Probabilistic Seismic Hazard Analysis (PSHA) that affect the maximum peak ground acceleration (PGA) for a given return period. Largest effect is “partitioning factor”.	Mean PGA based on averaging over statistical distribution of possible partitioning factors. Peak value 0,55g (approx.).	Down	Unknown (estimated, peak value in range 0,3g–0,55g)	Down	3 years	No
Averaging period over which equivalent 475-year (Eurocode 8 return period) ground motion is evaluated.	10 year period.	Down if a shorter period (5 years is considered), taking into account immediate risks. Up if a longer period is considered (20 years) due to increase in hazard with production.	Unknown (estimated 10%–20%). Unknown (estimated 10–20%).	None. This relates to interpretation of existing results.	N.A.	No

Influencing factor and sources of uncertainty	Currently assumed value	Likely direction when more data is obtained	Possible range	Influence on number and extent of interventions	Estimated time frame to reduce uncertainty	Within Arup scope of work	
Ground motion characteristics	Frequency content of expected ground motions.	Response spectral shape based on Eurocode 8, Type 2, Site Class E shape.	Down	For 1–2 storey buildings, 0–10%; for taller buildings, 20–30%.	Down	1 year	Yes
	Expected duration of ground motions.	Not currently taken into account, but have used design guidance for longer duration motions.	Down	Depends on building typology and target performance level: 0–60% reduction.	Down	1 year	Yes
Local ground conditions	Local geological profile, especially shear wave velocity in top 30m of soil.	Uniform over study area	Up and down depending on geography.	Local increases and or decreases based on site specific conditions.	Unknown	2 years	Yes

Table 15 Structural Capacity model uncertainties.

	Influencing factor and sources of uncertainty	Currently assumed value	Likely direction when more data is obtained	Possible range	Influence on number and extent of interventions	Estimated time frame to reduce uncertainty	Within Arup scope of work
Analysis method		Simple – Linear dynamic	Complex – Non-linear dynamic	1,0–4,0 (includes influence of duration and ductility)	Down	1 year	Yes
Knowledge of buildings and materials	Knowledge factor	0,75	1,0	0,75–1,0	Down	3 months	Yes
Duration	Increase in effective capacity for smaller duration motions	1	Unknown but likely down for masonry buildings of normal importance	1,2–1,6	Down	2 years	Yes

	Influencing factor and sources of uncertainty	Currently assumed value	Likely direction when more data is obtained	Possible range	Influence on number and extent of interventions	Estimated time frame to reduce uncertainty	Within Arup scope of work
Ductility	Allowable ductility factor	Depends on governing action but generally $m \approx 3,0$ for masonry walls and $q = 1,5$ for connections	Up due to influence of duration and specific building typologies. Down if NEN/NPR requires specific compliance with Eurocode 8.	$q = 1,0-3,0$	Down	3 years	Yes
Vulnerability	Threshold above which Level 2 permanent upgrade is required	0,1g	Up	0,05g–0,3g	Down	3 years	Yes
	Representativeness of building typologies and variations within typology	Assumed analyzed typologies are representative	Unknown			1 year	Yes

Table 16 Target Safety Level Uncertainties.

	Influencing factor and sources of uncertainty	Currently assumed value	Likely direction when more data is obtained	Possible range	Influence on number and extent of interventions	Estimated time frame to reduce uncertainty	Within scope of Arup
New buildings	Target performance objective for new normal importance buildings	Life Safety in 475 year return period ground motion.	Unknown	475–1000 years	Up when longer	1 year	No
	Improved seismic performance required for high importance buildings	Importance factors 1,2–1,4. Explicit targeted performance objectives to ASCE 41-13.	Not likely to change, but duration has less effect on higher performance objectives.			2 years	No
Existing buildings	Reduction factor to account for higher tolerable risk for existing buildings	2/3	Unknown	2/3–1	Up when bigger	1 year	No

5.2 Reduction of Uncertainties

5.2.1 Approach to uncertainty reduction

It is anticipated that, following a targeted programme, most uncertainties may be reduced within a timeframe of 2-3 years. In the meantime, appropriate conservative assumptions can be taken in order to progress with interventions that will reduce risk. Any assumptions must, at this stage, be reasonable and defensible. As the uncertainties reduce over time, advantage can be taken in the development of upgrading solutions. For them to be effective and usable, the regulatory framework will need to keep pace with the developments.

The approach to uncertainty is different for different building types:

- **New buildings:** Uncertainties can be taken into account in the design as soon as the NPR is published; and
- **Existing buildings:** Uncertainties cannot be taken into account in the original design, only to upgrading measures.

Therefore, reduction in uncertainties is much more important for existing buildings than for new.

5.2.2 Progress – Seismic Action

5.2.2.1 Interpretation of Probabilistic Seismic Hazard Analysis (PSHA) results

NAM will be responsible for procuring data and re-assessing the seismic hazard. The most significant parameter is the partitioning factor, and can only be refined in time with a larger data set.

5.2.2.2 Duration of ground motions in Groningen

It is important to study the ground motion durations expected for design earthquakes in the Groningen region. The following is proposed to be studied:

- Are different definitions of duration (other than “significant duration”) more appropriate for small ground motions such as those recorded in the 2012 Huizinge event?
- Are durations measured in induced earthquakes systematically lower than equivalent magnitude events from tectonic earthquakes?
- Are other (smaller) earthquakes recorded in the area better described by the prediction equations for duration?

These studies will establish with more uncertainty what durations can be expected in future earthquakes.

5.2.3 Progress –seismic resistance

5.2.3.1 Analysis methodologies

Increasing the complexity of the analysis methodology is expected to result in a decrease in interventions. The current studies are searching for the economic optimum in total costs of engineering and structural upgrading.

Based on the limited analyses performed the following learning can be drawn:

- Work in progress on non-linear analyses on a limited number of models shows significantly lower demand and higher capacity than simpler models;
- Different methodologies are emerging as being appropriate for different building typologies; and
- The LS-DYNA results are currently incomplete and should be calibrated against material models with experimental test data.

5.2.3.2 Information and knowledge on buildings and materials

Several studies are currently in progress (cavity walls, soil-structure interaction, material testing) and several code-defined assumptions are being investigated (knowledge factor, strengthening level). In due course, these studies are expected to reduce seismic demand and increase seismic capacity. This is work in progress and no definite conclusions are available at present.

Based on the limited analyses performed the following learning can be drawn:

- Cavity walls and soil-structure interaction study currently indicate a relatively small benefit in relation to seismic demand compared to the initial/base assumptions; and
- Knowledge factor and upgrading objective (see Section 6.4) both increase seismic capacity by factor 1/0.75 to 1/0.66.

5.2.3.3 Ductility

One of the key assumptions/uncertainties in the seismic resistance model is the allowable ductility that may be taken into account for Netherlands building stock. This is work in progress and no definite conclusions available at the time of writing.

5.2.3.4 Effect of ground motion duration on structural response

Several studies have already been carried out on the effect of ground motion duration on structural response. So far, the results are not consistent, with particular differences between the Pinho and Crowley study and the Arup studies. The main difference between these studies appears to be the way in which cyclic degradation of structural response is measured. This will be calibrated with experimental testing of Dutch URM building typologies.

The duration studies will also be expanded to assess directly the effect of duration on different modes of structural response, e.g.: out-of-plane response, in-plane rocking, sliding, toe crushing etc. It is not possible to conclude from the current studies that all modes of response will be similarly affected by ground motion duration.

5.2.3.5 Vulnerability

An important aspect of the structural upgrading study is the determination of the lower-bound threshold of acceleration for which no seismic intervention is required. This is work in progress, and no definite conclusions are available at the time of writing.

Based on the limited analyses performed the following learning can be drawn:

- A lower bound threshold around 0.05-0.10g from current linear dynamic analyses, which are believed to be conservative; and
- The lower bound threshold is to be calibrated based on analytical modelling and observed evidence from previous earthquakes, which suggests that 0.1g – 0.2g is reasonable.

There are many differences between individual buildings within each typology and the representativeness of individual analysis models for assessing the total population of a typology. The development of a design guideline to assess individual buildings for their seismic performance is currently in progress. This is work in progress and no definite conclusions are available at the time of writing

Based on the limited analyses performed the following learning can be drawn:

- Results show that terraced houses and semi-detached houses are more vulnerable than other typologies for any given level of ground acceleration;
- The amount of shear wall per house and corresponding axial loads are a governing factor in determination of vulnerability; and
- Investigation of more sub-typologies of Groningen building stock for the most vulnerable and numerous typologies in the region of highest hazard is recommended.

5.2.4 Target safety level uncertainties

This will, in due course, be defined by the NEN through a NPR with input from TNO.

This may involve the following considerations:

- a balanced point of view on levels of the probability and occurrence of different levels of earthquake ground motion, and the consequences of their occurrence for new and existing buildings; and
- Tolerance of the local community to risk from induced earthquake ground motion.

6 Conclusions

6.1 Design Methodology

In the absence of a regulatory framework for seismic design in the Netherlands, international guidance/codes have been reviewed and a methodology has been developed that combines the applicable Eurocode 8 and the American Society of Civil Engineering (ASCE) approaches. ASCE 41-13 Seismic Evaluation and Retrofit of Existing Buildings is currently in draft form and expected to be released early in 2014. It represents the state-of-the-art of engineering knowledge in the assessment of URM structures under seismic action. This is an area in which the Eurocode 8 does not incorporate the most up to date guidance.

Earthquakes in the Groningen area are induced; of much smaller magnitude and duration compared to the large tectonic earthquakes on which the guidance in ASCE 41-13 has been based. Consequently, research into the background data and test results of ASCE 41-13 has been undertaken to test the applicability to Dutch building stock and additional research has been identified (i.e. rocking mechanisms and out-of-plane stability of slender walls) to develop specific guidance to be applicable in the Groningen region.

Limit States and the performance-based approach used in the Eurocode 8 and ASCE 41-13 respectively for different building types have been correlated and subsequently used. This was found to be an appropriate basis for establishing the seismic demand; seismic capacity assessment and performance of the buildings in this study.

International precedents for determination of the upgrading objective for existing buildings have been presented and discussed.

Use of the Eurocode 8/ASCE methodology with non-linear assessment methods are proposed as a framework for future adoption as the primary means to assess the most common URM buildings in the higher seismic risk area.

The aim of the methodology is to develop design procedures, rules and protocols for structural upgrading of building stock within the context of Dutch practice in the Groningen region and the available regulatory framework. Although its use in the Netherlands is currently on a voluntary basis, Eurocode 8 provides a mechanism for management of risk from induced earthquakes. Eurocode 8 is localised in each country of the EU through a National Annex that focusses on the issues of seismic hazard; site response and local construction practice. A National Annex is not currently available in the Netherlands, but a precursor in the form of a NPR is currently under development. The learning and results from this study is intended to be made available as input for the NPR for existing buildings.

6.2 Analysis Methodology

Several analysis methodologies have been investigated as part of the study to test their validity and accuracy to different building typologies. The aim in each case has been to strike an appropriate balance between accuracy and speed of assessment. From the study it is concluded that different analysis methodologies may be used for different building typologies.

For low levels of PGA or when performance requirements are linked to no or negligible damage (DS0 and DS1) linear-elastic analysis can be used in an accurate way.

For larger PGA's and with the acceptance of significant damage (DS4) for performance requirements associated with life safety, non-linear analysis can take into account the non-linear more ductile response of the building and is required in order to achieve more accurate results and hence better insight in required upgrading measures. This is especially the case when the analysis is for a special building or is representative for a typology or sub-typology, representing a larger proportion of buildings.

For larger PGA's an alternative approach is to use a linear-elastic analysis, together with ductility factors, based on material, (sub) typology or failure mode. These ductility factors are not available for the Groningen building stock, while currently codified ductility factors give limited ductility for URM buildings or building parts. After calibration through physical and numerical non-linear testing, a linear analysis methodology that takes into account the representative ductility of Dutch building stock may provide a more efficient overall procedure. This methodology may be more amenable for general, large-scale deployment within the engineering community. Development of such simplified method may take one to three years.

6.3 Seismic Performance - Building Level

6.3.1 Relative performance

Although the number of typical buildings studied is limited, the following factors are seen to influence building performance:

- Wall openness (e.g. windows and doors);
- Wall type; and
- Building mass (which is a function of mass of floor construction and number of storeys).

Based on linear-elastic modal analysis, two groups are distinguished:

- **The more vulnerable** typical building sub-typologies, comprising terraced buildings and semi-detached buildings; and
- **The less vulnerable** typical building sub-typologies, comprising detached house, labourer's cottage, mansion and villa.

The more vulnerable typical building sub-typologies are directional in their structural configuration and performance and are particularly vulnerable in the direction parallel to the front and rear façades. These façades are relatively open.

This wall openness originates from a design methodology commonly used to design these buildings for resistance to wind load on the gables, which resulted in relatively narrow masonry piers per terraced house to resist lateral loads in that direction. In this group all the buildings are three storeys and all walls are cavity type. Buildings with relatively light floors perform better compared to buildings with relatively heavy floors.

The less vulnerable typical building sub-typologies are non-directional. In this group most buildings are two-storeys and most buildings have solid walls. Buildings with relatively light floors perform better compared to buildings with relatively heavy floors.

Buildings with shop fronts, though not explicitly studied, are expected to perform similarly to more vulnerable typical building sub-typologies based on similar structural arrangements of load-bearing members.

Note that the differentiation in more and less vulnerable buildings is not yet made in the fragility curves used in the seismic risk study. At present the fragility curves represent a statistical representative estimate for all buildings with a differentiation only according to age. When more information becomes available about relative vulnerability this will be taken into account in the seismic risk study.

6.3.2 Life safety performance

When upgrading measures 2 and 3 are assumed to be implemented on the buildings studied, the threshold for partial collapse (Damage State 4 = DS4), such as wall failure, is used to assess life safety performance. (Probability of casualties from DS4 is relatively low).

Linear-elastic modal analysis shows partial collapse (DS4) at PGA's smaller than 0.1g. This is not consistent with the experience at the Huizinge earthquake where maximum observed component PGA's of 0.08g were measured and the only damage observed was cracks in walls (DS1 and DS2).

Non-linear analysis shows partial collapse (DS4) for PGA between 0.15g to 0.5g dependent on building sub-typology and non-linear analysis method. For the sub-typologies studied – terraced houses and detached houses - partial collapse was observed at PGA's of respectively 0.3g and 0.5g on the basis of sophisticated non-linear time history analysis. Using the more simple, non-linear pushover analysis partial collapse was observed between 0.16g and 0.24g on the detached house sub-typology.

Definite conclusions about structural upgrading beyond level 3 is difficult, although these preliminary results show that the threshold where upgrading beyond level 3 is needed is tentatively between 0.15g and 0.5g. To be more confident the non-linear analysis needs calibration with physical laboratory tests.

6.3.3 Specific performance

All buildings investigated were assumed to require ties between the walls and floors/roof to transmit seismic loads. The magnitude of the tie forces was found to be a function of the number of storeys; the mass of the floor construction and the geometry of the building. Seismic loads were generally found to be much higher in magnitude than those from environmental wind loads. Buildings with flexible diaphragm floors (timber floors) were found to require stiffening to distribute seismic loads to walls in order to provide an adequate seismic load path.

- The **masonry piers** on the upper level were found to be more vulnerable than those on the ground floor due to the lower level of preload.

- Buildings with **concrete floors** were found to be more vulnerable than identical buildings with timber floors due to the former attracting a much higher base shear from the higher seismic mass.
- Buildings with **cavity walls** were found to be more vulnerable than those with solid walls of similar overall thickness.
- The **barns**, due to their flexible timber-framed construction, were found to be less sensitive to seismic effects as wind loads dominated the overall building loads. Seismic effects on masonry walls would require localised strengthening.
- The **church** had pre-existing cracks and settlement of the bell tower and was found to require substantial tying and foundation strengthening.
- The **school** was found to require substantial tying and general strengthening due to a lack of reliable diaphragm action of the roof, and a complex, irregular geometry.
- The **utility buildings** were found to need significant structural upgrades comprising wall and foundation strengthening. The requirement to be operational after a seismic event was found to be a principal driver of the need for substantial intervention.

6.4 Seismic Performance - Building Element Level

6.4.1 Cavity walls

Perimeter cavity walls typically comprise an inner load-bearing leaf and outer non load-bearing leaf. For the inner leaf, the preload greatly assists the in and out-of-plane capacity and provides the majority of the seismic capacity of the wall. The capacity is strongly influenced by the thickness, and therefore slenderness of the leaf. The outer, non-loadbearing leaf contributes to the seismic resistance by reducing the effective slenderness of the inner leaf for out-of-plane effects, and potentially provides some contribution to the in-plane strength. The degree of in-plane strength contribution was found to be sensitive to the nature of the connectivity between the leaves (lintels, cills, roof plate etc.) and the level of PGA.

As the inner leaf is generally thinner and more slender than a solid wall, even considering beneficial effects of the outer leaf, buildings with cavity walls are more vulnerable than those with solid walls.

The anatomy of historical cavity wall construction practice in the Groningen area has been studied as a basis for performance evaluation.

Methodologies for the analytical representation of the contributing mass, stiffness and strength of the outer, non-loadbearing leaf have been investigated; tested numerically and compared against international guidance and practice. In and out-of-plane strength have been assessed using deemed-to-satisfy geometrical requirements in ASCE 41-13. Geometrical limitations in ASCE 41-13 have been investigated using non-linear time-history analyses and the preliminary findings suggest that additional capacity may be available for the construction types used in the Groningen area.

International literary research is currently underway to investigate existing test data for cavity wall capacity in and out-of-plane, followed by potential physical testing and verification of non-linear numerical models.

6.4.2 Soil-structure interaction and foundation capacity

In order to investigate the effects of soil-structure interaction and foundation capacity, an iterative methodology was developed to model the non-linear interaction and seismic response of the buildings. The methodology was developed to test the sensitivity to sub-soil stiffness and levels of PGA.

The preliminary findings were that a period shift was evident once the flexibility of the soil was taken into consideration. This may or may not result in a change in base shear, depending on the discrete response modes and their periods with respect to the response spectrum plateau.

The studies indicated that most buildings are likely to generate soil stresses in the region of the ultimate limit state capacity at a PGA of approximately 0.25g, and overstress the soil under the foundations at a PGA of 0.5g. Studies to determine the implications of short-term soil over-stress are underway. Foundations with shallow embedment were found to be particularly susceptible to overstress. Techniques for possible soil improvement are currently being investigated.

6.5 Structural Upgrading Measures

The results from the analyses and assessments determine the requirement for upgrading measures. Feasible preliminary structural upgrading measures and options suitable for local implementation have been developed for each building investigated. These measures have been proposed as being appropriate for prevention of life-threatening damage and are developed taking due consideration of local capabilities, social disturbance and aesthetic sensitivity. Seven levels of permanent upgrading measures have been characterised within the study. Commencing at Level 1, the upgrading levels have been set out in order of the most effective solutions that can be deployed most rapidly to reduce risk most quickly whilst minimising impact for inhabitants. Complexity, duration and impact on inhabitants increases with increasing intervention level.

When an intervention is required this will be a mix of different permanent and temporary upgrading measures.

Permanent upgrading measures – intervention levels:

- **Level 1:** Mitigation measures for higher risk building elements (potential falling hazards);
- **Level 2:** Tying of floors and walls;
- **Level 3:** Stiffening of flexible diaphragms;
- **Level 4:** Strengthening of existing walls;
- **Level 5:** Replacement and addition of walls;
- **Level 6:** Foundation strengthening; and
- **Level 7:** Demolition.

Temporary upgrading measures have also been identified for specific building types for rapid risk reduction, for example terraced houses, semi-detached houses and shop front buildings which have been identified as being more vulnerable. Temporary upgrading measures are exterior to the building and provide lateral support to the building (e.g. steel “bookend” frames). Temporary upgrading is to be considered for these buildings to mitigate short-term risk until permanent solutions are available.

A key consideration under investigation is the seismic hazard threshold below which no intervention is required. The determination of this threshold is under development and will be investigated based on analyses and physical testing. The current expectations are that this threshold will be for PGA's of 0.1g to 0.2g, based on observation in other countries with comparable URM building stock.

Non-structural elements can pose a significant risk to safety. Section 4.4.1. discusses the measures that can be undertaken to reduce risk.

6.6 Research and Investigations

High levels of uncertainties exist in the definition of the seismic hazard; structural capacity and target level of safety. These are too high at present for making reasonable and defensible decisions in a traditional way about the number and level of interventions required and the planning associated with this. Therefore, the current approach is based on step-wise risk reduction, in which steps of intervention and uncertainty reduction are undertaken in a prioritised and systematic manner through research and investigation. The studies relating to the structural resistance have been discussed in this report. Uncertainties are expected to reduce in the coming three years as more information and the outcomes of investigations become available.

7 Recommendations

7.1 Design Methodology and Development of Design Guidance

In the long-term it is recommended to develop the National Annex for Eurocode 8 that incorporates design guidance for structural upgrading of the Groningen building stock within the context of Dutch building practice. It is recommended that this will take into account the specifics of the Groningen building stock, the specific seismic hazard in the Groningen region and a specific target safety level for the Netherlands in respect to life safety in relation to seismic events.

As the National Annex will take time to develop it is recommended for the short-term to adopt a design basis for structural upgrading that is a combination of Eurocode 8 and ASCE 41-13.

This short-term basis can serve as a basis for the Nationale Praktijk Richtlijn (NPR) the precursor of the National Annex. Purpose of this NPR is to give practical design guidance in absence of a National Annex.

As knowledge is expected to develop quickly it is recommended to update the short-term design basis each year and to incorporate this knowledge into the NPR.

As the Structural Upgrading Strategy is a step wise approach that starts with the pilot and implementation of permanent measures 1 up to 3 and temporary measures it is recommended to develop more specific guidance for these measures before the first version of the NPR becomes available in the spring of 2014.

7.2 Analysis Methodology

In the short-term it is recommended to use non-linear analysis for the assessment of building performance for larger PGA's and performance criteria that accept damage, in order to take the beneficial non-linear behaviour of buildings into account. In general, it is recommended to not use linear-elastic analysis in combination with currently codified ductility factors for the assessment of building performance, as this will give very conservative results. The use of linear-elastic analysis is recommended for low PGA's or with performance criteria that do not accept any or negligible damage.

In the long-term when and if codified ductility factors are established for the Groningen building stock, the use of linear-elastic is recommended. This will imply the development of ductility factors for building typologies and sub-typologies.

For buildings analysed in Pilot1, Phase 1 with only linear-elastic analysis, it is recommended that these buildings are analysed with non-linear analysis in Phase 2.

7.3 Structural Upgrading Measures

In the short-term it is recommended to focus on the development of detailed permanent and temporary structural upgrading measures for the more vulnerable typical building sub-typologies.

In the short-term it is recommended to focus on structural upgrading measures 1 to 3 and temporary measures.

7.4 Research and Investigations

To reduce model uncertainties in seismic action, seismic resistance and target safety level it is recommended to undertake additional research and investigations. For the seismic resistance/vulnerability, the aim of this research and investigations is to better understand the influencing factors and the influence of different levels of structural upgrading and specifically the different types of upgrading.

In the short term the following research / investigations are proposed:

- **Improve structural analysis and model methodologies:** extended comparisons to find a feasible methodology with the right balance of time/knowledge requirements and accuracy for assessment of forces and/or damage;
- **Calibration of models by laboratory testing** using scale or full scale physical models for total buildings, building parts and material testing. These studies aim to calibrate the analysis methodologies and model assumptions;
- **Calibration of models using field measurements** of ground motion, related building damage and ground settlement on real buildings in Groningen;
- **Improve fragility curves** for local building stock: production of a methodology to produce fragility curves using analytical non-linear models in combination with laboratory testing;
- **Building / soil structural interaction;**
- **Duration:** Extension of non-linear finite element calculations on 3-D models of total buildings, non-linear single degree of freedom models;
- **Testing of specific building elements or structural upgrading measures** by using non-linear dynamic and static model approaches in combination with physical laboratory tests;
- **Building stock variability** study to improve understanding in-plan and elevation geometry, material properties and detailing; and
- **Ground motion characteristics and local ground conditions.**

References

- [1] REP/229746/ST001 Structural Upgrading Strategy, Arup, Amsterdam (29-11-2013)
- [2] REP/229746/SR001 Seismic Risk Study – Earth quake Scenario-Based Risk Assessment, Arup, Amsterdam (29-11-2013)
- [3] REP/229746/IS001 Implementation Study, Arup, Amsterdam (29-11-2013)
- [4] NEN 8700 (2011), Beoordeling van de constructieve veiligheid van een bestaand bouwwerk bij verbouw en afkeuren – Grondslagen (in Dutch)
- [5] ATC 20 (1989) Postearthquake Safety Evaluation of Buildings, Applied technology council, Redwood city, California
- [6] Akkar S. , Sandikkaya M.A. , Bommer J.J. (2013) Empirical Ground-Motion Models for Point- and Extended-Source Crustal Earthquake Scenarios in Europe and the Middle East. Bulletin of Earthquake Engineering
- [7] De Vent, I.A.E. (2011), Structural damage in masonry: Developing diagnostic decision support, PhD Dissertation, Delft University of Technology, Faculty of Architecture
- [8] De Vent, I.A.E. (2011), Prototype of a diagnostic decision support tool for structural damage in masonry, Supplement to the PhD thesis of Ilse A.E. de Vent: Structural damage in masonry: Developing diagnostic decision support Delft University of Technology Faculty of Architecture
- [9] Eurocode 8 (EN 1998) Design of structures for earthquake resistance, European Standard (English version)
- [10] Assessment and Improvement of the Structural Performance of Buildings in Earthquakes (2006), New Zealand Society for Earthquake Engineering (NZSEE)
- [11] ASCE 31-03 (2003), Seismic Evaluation of Existing Buildings, American Society of Civil Engineers, Reston, Va
- [12] ASCE/SEI 41-06 (2007), Seismic rehabilitation of existing buildings, American Society of Civil Engineers, Reston, Va
- [13] ASCE/SEI 41-13 (2014), Seismic Evaluation and Retrofit of Existing Buildings, American Society of Civil Engineers, Reston, Va
- [14] ACI 440.7R-10 (2012), Guide for the Design and Construction of Externally Bonded FRP Systems for Strengthening Unreinforced Masonry Structures, ACI Committee 440, American Concrete Institute, Farmington Hills, Mich, 46p.
- [15] Eurocode 3 (EN 1993): Design of steel structures, European Standard

- [16] Korff M. et al (2013) Effecten geïnduceerde aardbevingen op kritische infrastructuur Groningen (Quick Scan naar de sterkte van de infrastructuur), Deltares rapport
- [17] Same as [18] (French version)
- [18] Plumier A., Doneux C., Capolaretti V. (2003), Belgian earthquake-resistant technical guide for detached houses, SSTC, Universite de Liege
- [19] Plumier A., Doneux C. ,Capolaretti V. (2002), Evaluation et reduction du risqué sismique en Begique dan la cadre de l'Eurocode-8, Rapport d'avancement n4, recherché SSTC, Universite de Liege (in French)
- [20] Plumier A. et. Al (2003), Seismic Risk Assessment and Mitigation for Belgium in the frame of Eurocode 8, University of Liege
- [21] Degee H. and Plumier A. (2006) Experimental Investigation on the seismic behavior of masonry housing in low seismicity areas. Proceeding of First European conference on Earthquake Engineering and Seismology. Geneva, Switzerland

Appendix A

Seismic-Resistant Design

A1 Philosophy

Damaging earthquakes are generally considered a relatively rare event but are potentially of high impact and hence a hazard for buildings and other structures. Earthquakes lead to strong ground shaking at distances ranging from 10s to 100s of kilometres away from their source, depending on the magnitude of the earthquake. This ground shaking is the primary source of damage to buildings. Secondary sources of damage include ground failures, liquefaction and ground faulting underneath the building.

For new construction, the objective of seismic design principles and codes of practice is to not experience significant damage under frequent, smaller earthquakes – called damage limitation, and to have sufficient confidence that occupants will not be severely injured or killed under a rare, larger earthquake-called life safety. In practice, the smaller and more frequent events may cause local minor damage. The definition of what is considered a “rare” and “frequent” ground motion is based on the seismicity of the area and is defined on the basis of a certain confidence that the level of ground shaking will not be exceeded over the life of the structure.

Even in highly seismic areas, large earthquakes are relatively rare. Therefore, it is not considered economical to design conventional buildings to remain undamaged under the rare ground shaking associated with a large earthquake. Design codes are based around ensuring that the building remains standing so that building occupants can safely exit the damaged buildings. This is referred to as life safety design. Buildings designed for life safety can still be significantly damaged when subjected to the level of shaking foreseen by the design code.

Well-designed structures incorporating the best practice in seismic design can undergo significant ductile deformation and damage without compromising the life safety. Through this ductile deformation, seismic energy is absorbed. Figure 47 overleaf shows examples of structures that behave in a ductile way and can be designed assuming non-linear forces level. Structures without specific seismic design may fail in a brittle manner without accommodating the deformations imposed upon them by the ground movement.

Different structural materials and structural systems achieve different levels of ductility, depending on details of their design. Seismic design of new structures avoids brittle failure by specifying a predictable yielding mechanism, and then overdesigning other mechanisms that would otherwise result in brittle failure. One result of this philosophy is that joints and connections must be designed to remain intact under large displacements while other structural members may be permitted to undergo damage. Ductility also depends on the structural material used: steel and reinforced concrete or masonry reinforced with steel bars can be made to be ductile if detailed correctly; unreinforced masonry is relatively brittle, and its response is difficult to control in design.

The philosophy adopted in this study is to design for life safety. This may result in a building that is severely damaged and potentially unusable after a large seismic event.

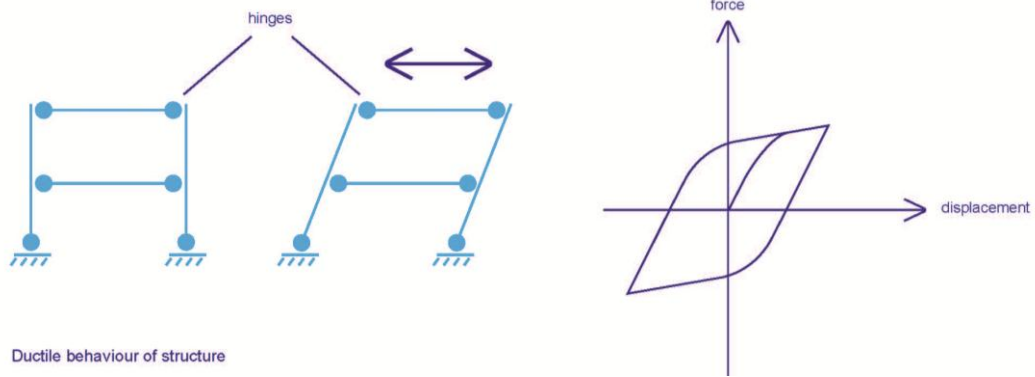
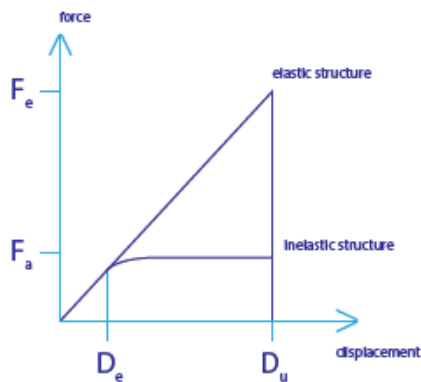
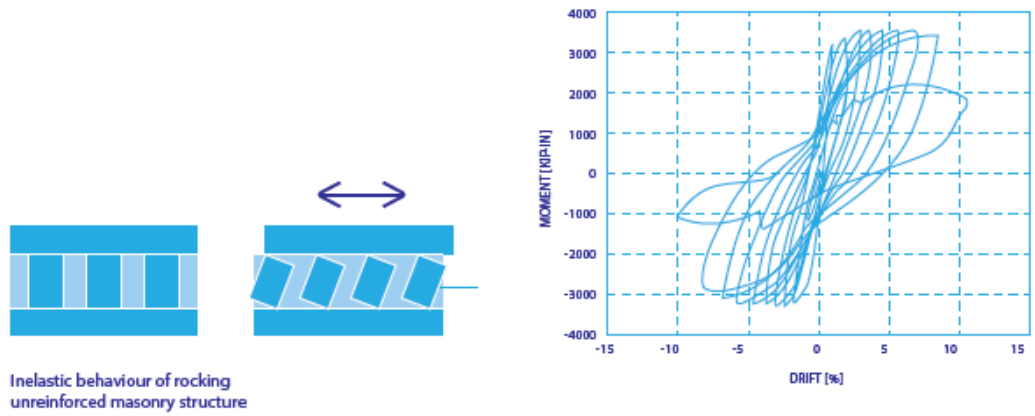

Figure 46 Ductile Behaviour of steel structure and unreinforced masonry structure.



$$F_a = \frac{F_e}{q}$$

Inelastic structures can be designed a force level F_a

Figure 47 Inelastic structures can be designed a force level F_a .

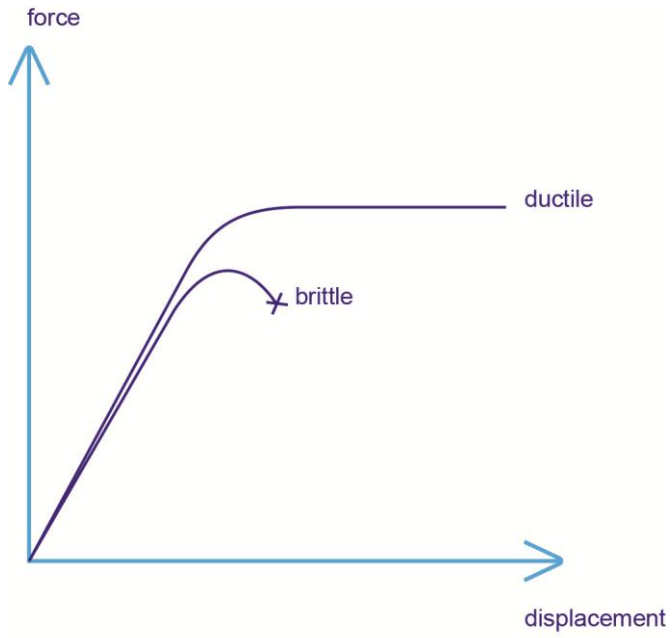

Ductile vs brittle behaviour

Figure 48 Ductile and brittle behaviour of materials and structure

A2 General Principles

The shape and configuration of buildings have a significant influence on their behaviour under earthquake loading. When designed according to the general principles, deformations and concentration of forces will be minimized resulting in a reduction of associated damage.

The general principles for seismic resistant design are:

- **Limited mass** – imposed earthquake forces are proportional to the total mass, so heavy buildings often perform worse than lighter buildings;
- **Regularity in plan** – seismic performance is improved by having a regular distribution of load-resisting elements and mass, avoiding torsion; symmetric floor plans with an even mass distribution are preferred; plans with L, T, U, V, Z shapes introduce significant torsional stresses and should be avoided; centre of mass and centre of rigidity should be as close as possible; See Figure 50.
- **Regularity in elevation** – seismic performance is improved by gradual changes in stiffness, avoiding the concentration of forces with sudden changes in stiffness; flexible levels should be avoided, including “soft storeys” in buildings with open ground floors and stiffer upper floors; See Figure 50.
- **Choice of material and detailing** – materials that can accommodate large deformations and force-reversals in a ductile and stable way are preferable over those that cannot. Well-detailed steel, timber, reinforced concrete or reinforced masonry buildings are preferred; unreinforced masonry is known to exhibit more brittle behaviour and to be particularly vulnerable to earthquakes;
- **Continuity** – buildings should be well tied together to distribute forces to load resisting members and to assure overall response;
- **Distribution of live loads** – heavy live loads should be placed lower in the building and close to the centre of rigidity;
- **Redundancy** – different load paths will enable the building to resist seismic forces even when some members fail; and
- **Distribution of seismic-resisting elements** – seismic resisting elements should be distributed as close to the perimeter of the building as possible, creating the largest possible lever arm and thereby the largest overall resistance.

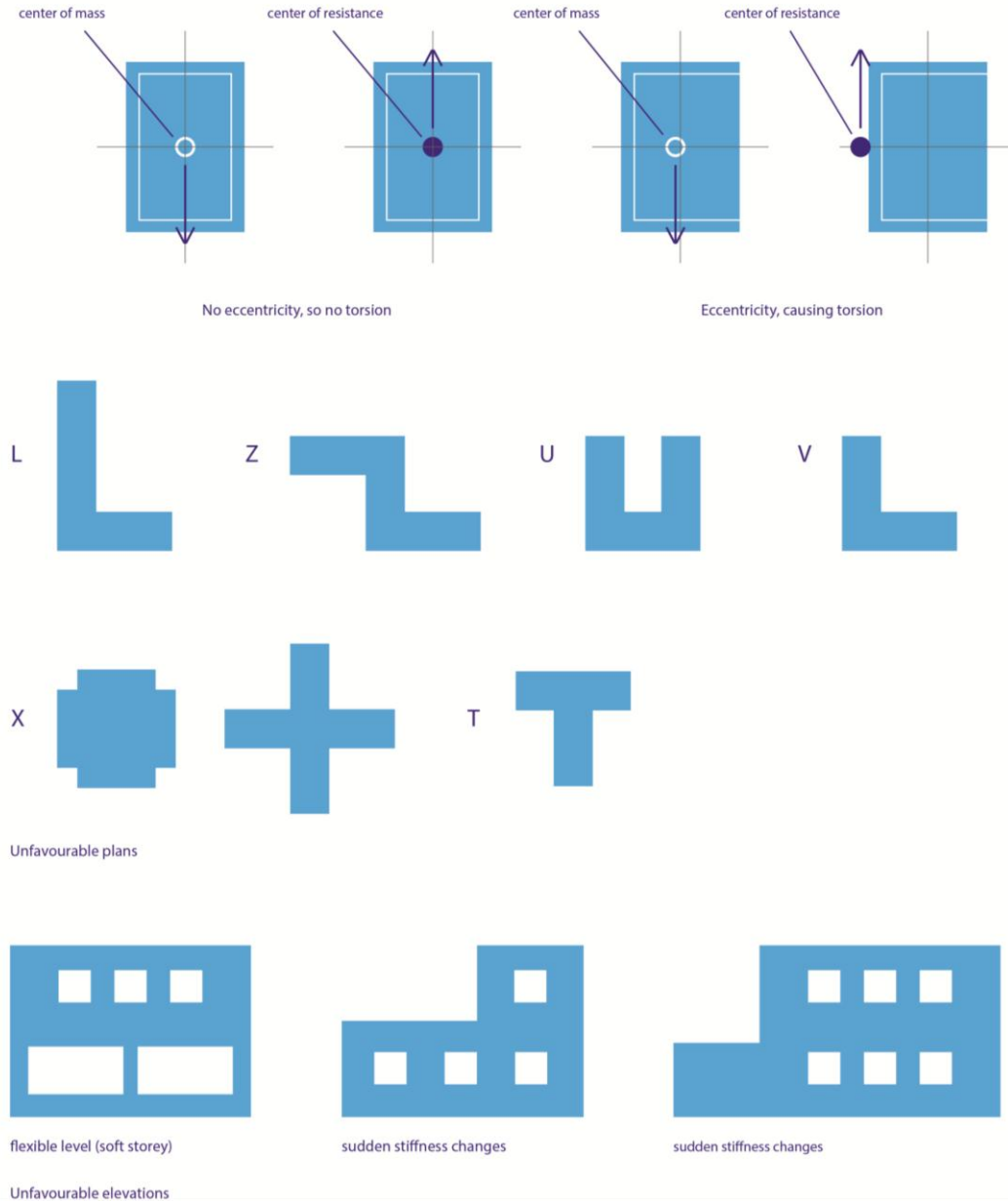

Figure 49 Geometry of buildings in plan and elevation.

A3 Seismic Behaviour of Unreinforced Masonry Buildings

A3.1 Seismic Resistance and Load Path

Earthquakes induce primarily lateral forces by their inertia when the ground is moving. Lateral forces are also induced by wind load. The wind load is proportional to the size and shape of the building, whereas seismic loads are proportional to the mass of the building. The ratio of seismic load to wind loads gives an approximation as to the magnitude of the additional resistance that may be required for a seismic retrofit. The ratio is indicative only as there is no

information as to whether the buildings concerned have been designed to resist wind load in accordance with current code requirements. The distribution of load from seismic and wind events is quite different. Therefore, seismic strengthening may still be required even if the estimated wind load exceeds the seismic load.

Buildings in the Groningen area have not been engineered for seismic loads, like most masonry buildings worldwide. Non-engineered buildings resist wind and earthquakes by their box behaviour. The box offers resistance by the combination of its elements – floors, walls and roof. See Figure 50.

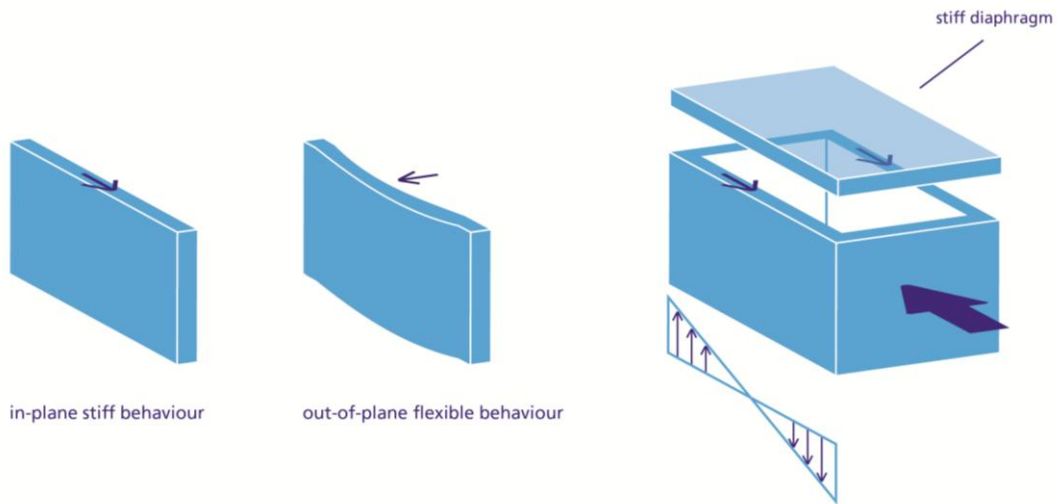

Figure 50: Box behaviour

Forces are generated by the accelerations of the mass of these elements. The different elements have different functions in this resistance:

- Floors and roofs distribute the forces, generated by their mass and imposed loads to the walls;
- Floors and roofs tie the walls together, restraining them against collapsing out of plane;
- Walls offer high in-plane resistance in the direction of the ground motion and transmit the forces to the foundation; and
- Walls offer low out-of-plane resistance in the direction perpendicular to the direction of the ground motion.

A3.2 Stiffness of Diaphragms

The floor and roof diaphragm configurations have different behaviours depending on the stiffness of these diaphragms. Stiff diaphragms distribute the forces in relation to the stiffness of the walls. In this case the loads are primarily resisted by in-plane resistance of walls, in the direction of the earthquake. Flexible diaphragms distribute the forces in relation to the tributary mass assigned to each wall. Consequently, some walls have to resist significant loads in the weak out-of-plane direction. This is a very unfavourable behaviour. In addition, they do not transmit forces caused by overall torsion of the buildings, and the diaphragm offers less restraint to the walls for out-of-plane failure. Consequently, stiff diaphragms are favoured over flexible diaphragms for their superior behaviour. See Figure 51.

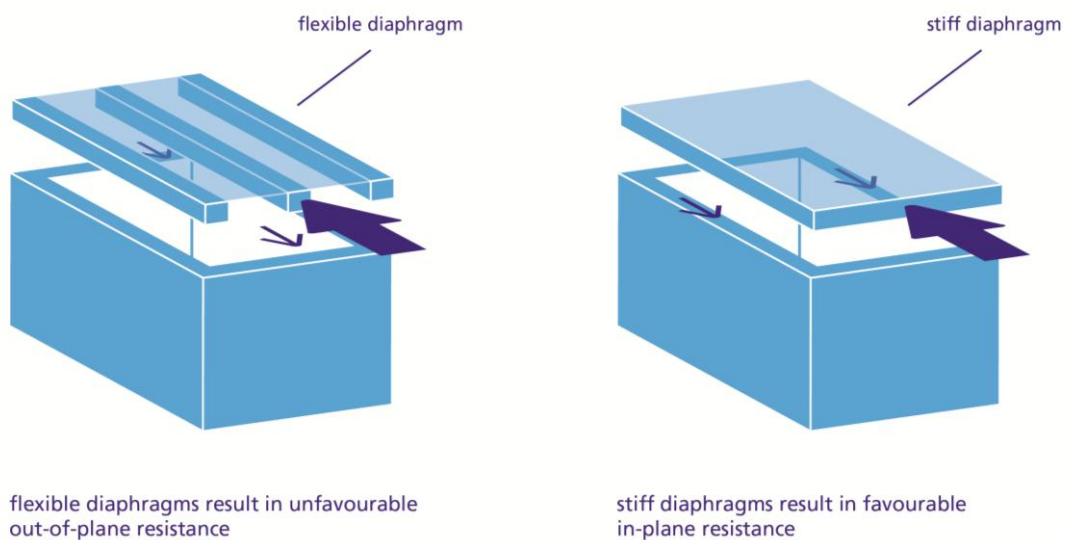

Figure 51: Diaphragm.

A3.3 Ties

Another function of the floor and roof diaphragms is to tie the walls together. This is important for two reasons:

- It prohibits unfavourable failure mechanisms in out-of-plane direction by changing the boundary conditions of the wall (See Figure 52); and
- It prohibits separation between walls/walls, wall/roofs and walls/floors. In particular, the separation of wall/floors permits unfavourable observed failure mechanisms such as out-of-plane tipping of walls and floors collapsing (See Figure 54).

In general, the connections between the floor and roof diaphragms and the walls rely on friction. For adequate seismic performance, positive mechanical ties with adequate over strength are essential.

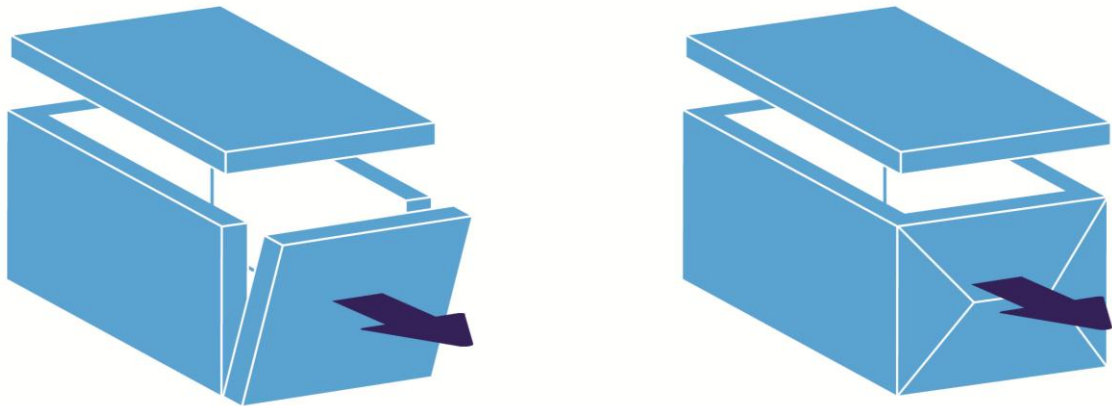
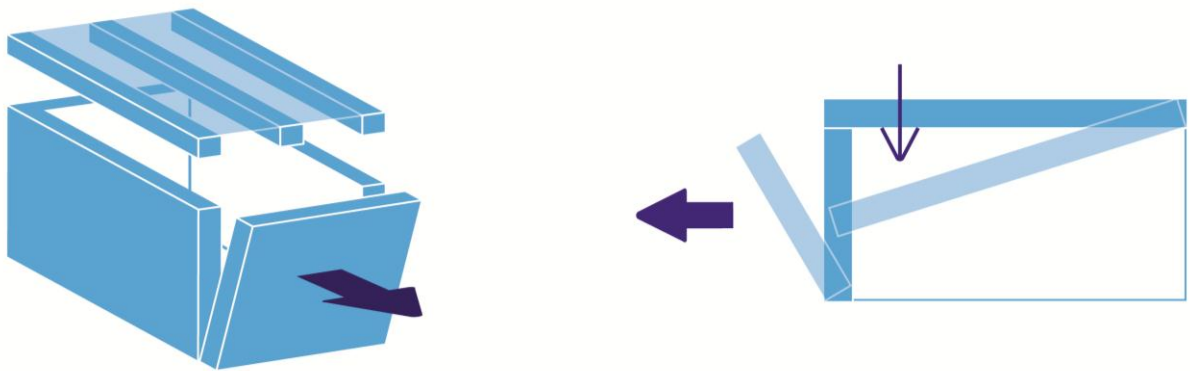

Figure 52 Out-of-plane force effect without and with diaphragm



separation of walls leads to out-of-plane tipping and floor falling

Figure 53 Separation of walls

A3.4 Wall Distribution

Apart from the more general structural distribution issues addressed in 3.2, the plan proportions and the wall distribution must be compatible to react like a box or a combination of boxes. Elongated plans should therefore have additional walls in the short direction distributed along the long side of the building (see Figure 54).

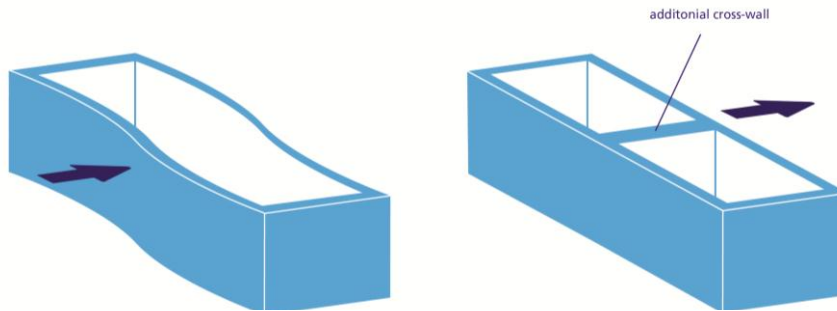

Figure 54: Wall distribution

A3.5 Seismic Damage

Earthquake damage is frequently recorded and reviewed. Most significant damages result from the following causes:

- Lack of connections, between wall/wall, walls/roof and wall/floors;
- Out-of-plane collapse of walls in direction perpendicular to earthquake direction (especially the outer leaf of cavity walls); and
- In-plane wall failure.

In-plane failure depends primarily on:

- Load on top;
- Opening configuration (see Figure 56);
- Length of walls;
- Wall thickness; and
- Material properties.

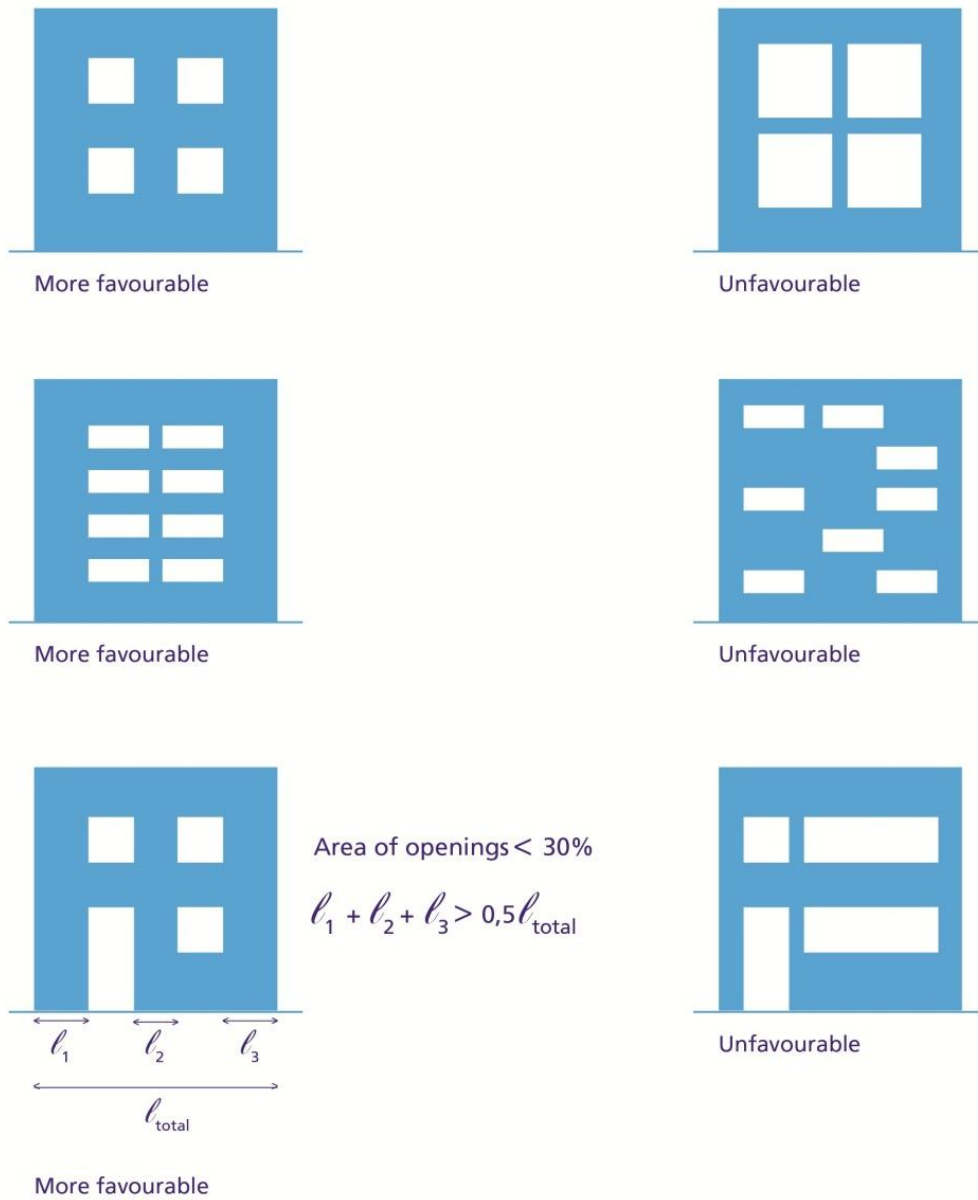

Figure 55: Openings configuration.

When tied to the floors diaphragms, wall out-of-plane failure is mainly influenced by the floor height to wall thickness ratio; load on top and, for cavity walls, the presence of wall ties to restrain the outer leaf.

Worldwide, there are extensive data on building damage for existing buildings, but also for existing buildings with structural upgrading measures. For the purposes of this study, the most relevant earthquakes are:

- **Liege, Belgium** earthquake: similar buildings stock;
- **Roermond, The Netherlands** earthquake: similar building stock;
- **New Zealand** earthquakes: similar building stock and structurally upgraded buildings, for which damage is well recorded;
- **California** earthquakes: similar building stock for which damage is well recorded; and
- **L'Aquila, Italy** earthquake: some similar buildings stock.

A3.6 Research in Masonry Buildings

There is significant research on the behaviour of masonry buildings. The research is sub-divided into the following areas:

- Shaking table tests on total buildings to investigate total behaviour;
- In-plane pier tests, as a proxy of the in-plane wall behaviour; and
- Out-of-plane pier tests, as proxy for out-of-plane wall behaviour.

Appendix B

Strategies to Improve Structural Performance

B1 Strategies to Improve Structural Performance

Strategies to improve structural performance may be achieved by using one or more of the following strategies:

- **Local modifications of components:** when the overall strength and stiffness of the building is adequate, some of the components (members, connections) may have a lack of strength or inadequate deformation capacity and form weak links in the seismic load path. Local improvements to members and connections can be made in respect to connectivity, strength and deformation capacity;
- **Removal of plan and elevation irregularities:** Plan irregularities cause unwanted torsion in the building, while stiffness discontinuities and differences can result in force concentrations. The performance of the building can sometimes be improved by disconnection and separation of buildings into regular building parts; or removal of elements to align mass and rigidity centres and to ensure that stiffness changes are gradual rather than abrupt (see Figure 56 Removal of geometric irregularities);
- **Decreasing building mass:** The forces acting upon the structure during an earthquake are directly proportional to mass. As such, removal of unnecessary mass results in smaller forces. Examples are brick veneer, non-structural masonry, interior walls or masonry chimneys;
- **Increasing building strength:** For flexible structures where critical components do not have adequate ductility, stiffening of these components will increase elastic strength and reduce the need for ductility of these components;
- **Increasing building ductility:** This relies upon transforming the building into a system that allows for a controlled deformation mechanism. In this way the building is allowed to experience larger deformations whilst retaining its capacity to carry the gravity forces. Materials will deform plastically and absorb energy;
- **Supplementary energy dissipation:** The energy delivered by the earthquake is absorbed by the structure. Damping is a measure of energy dissipation. All structures possess some inherent damping. Additional damping can be introduced by installing passive energy dissipating devices, such as hydraulic cylinders, yielding plates or yielding braces (see Figure 58).
- **Seismic base isolation:** The building can be isolated from the majority of seismic motion by mounting it on isolators. The building period would significantly increase, reducing seismic action on the building. In addition, this base isolation system could increase damping by employing special energy dissipating devices into the isolation system (See Figure 58).

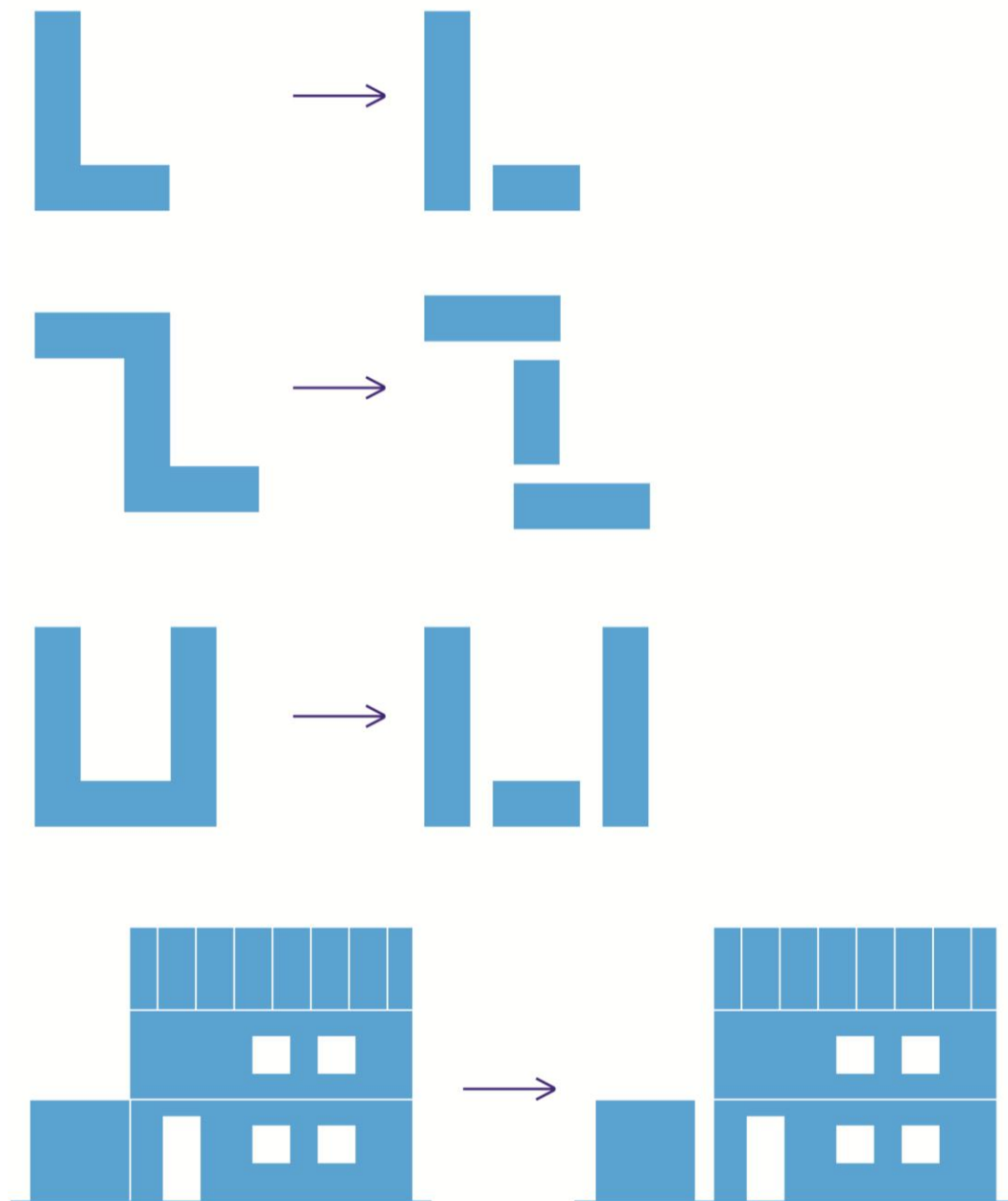

Figure 56 Removal of geometric irregularities

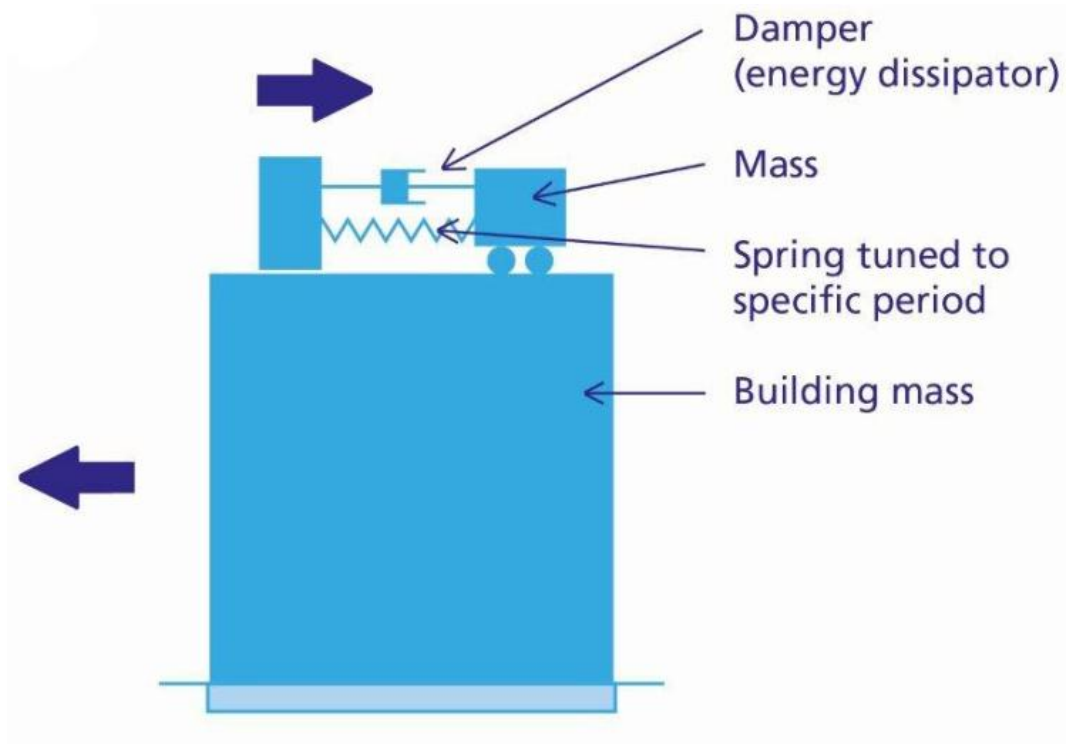

Figure 57 Passive tuned mass damper (TMD).

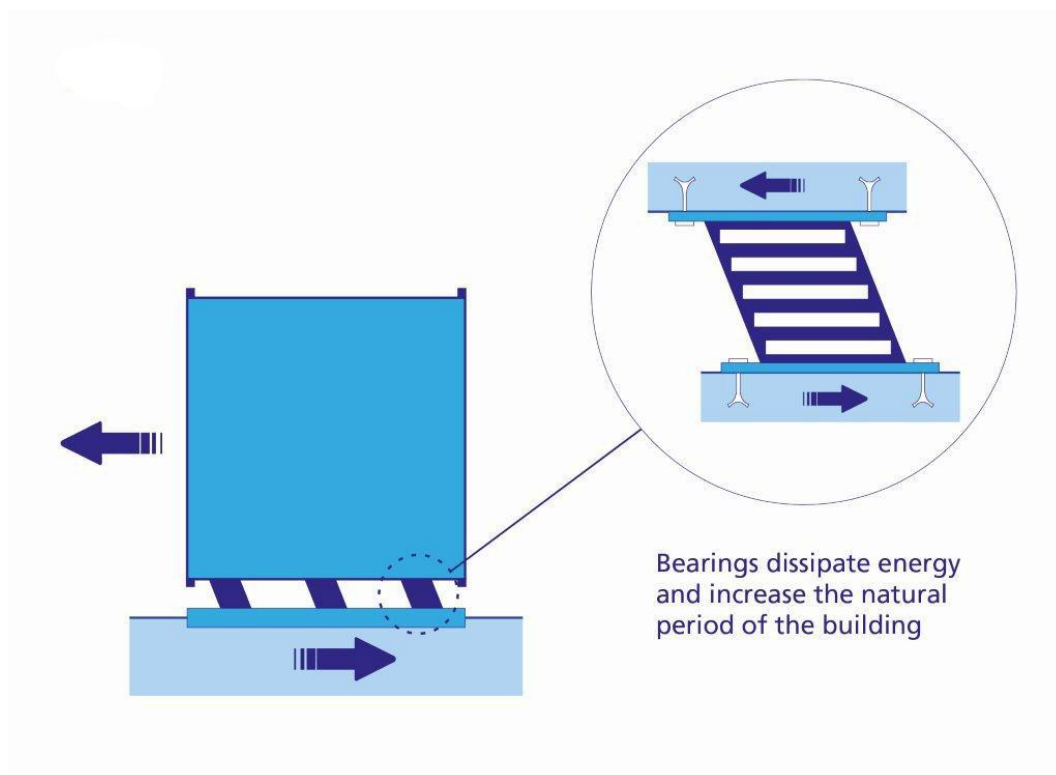

Figure 58 Seismic base-isolation.

B2 Conventional Measures

B2.1 Additions or replacements

Conventional measures for structural upgrading at building level are to integrate or replace current structure with:

- Reinforced concrete shear walls;
- Reinforced concrete or steel moment frames;
- Steel V-braced or X-braced frames;
- Steel yielding braced frames;
- Reinforced masonry wall; and
- Timber braced or moment frames.

B2.2 Upgrade elements

Conventional measures for structural upgrading of masonry buildings are:

- **Tying:** Improve the integrity of the structure by tying elements together;
- **Diaphragm stiffening:** Increase the stiffness of floor and roofs diaphragms to enable them to distribute seismic forces to the stability system elements;
- **Wall capacity:** Increase in-plane wall flexural and shear capacity and ductility;
- **Increase out-of-plane wall flexural capacity;** and
- **Foundations:** Distribute seismic stability forces to substructure elements capable of resisting the seismic demand, or upgrade the substructure as necessary.

For unreinforced masonry buildings with timber floors, the following approaches are used:

- **Overall integrity upgrading:**
 - **Tying or removing high-risk elements:** Reduce the risk of collapse of high risk building elements such as chimneys, ornaments, parapets, cantilever walls, and brick veneer cavity walls by tying those elements to the structure or removing them (see Figure 59).
 - **Tying walls/floors, wall/roof and wall/wall:** All walls should be firmly tied to floors and roofs and each other. Connections can be improved through the use of wall ties and anchors (see Figure 60).
- **Stiffening timber floor and roof diaphragms:**
 - Concrete topping overlays on top of the existing timber floor;

- Steel truss system below the timber floor; and
- Timber overlay on top of the existing timber floor.
- **Wall in-plane structural upgrading:**
 - **Overlay concrete shear walls:** overlay concrete shear walls can be used to strengthen and improve ductility of unreinforced masonry walls. Often foundation strengthening is needed to allow for additional mass (see Figure 61 and Figure 62).
 - **Composite fibre reinforcement:** Overlays of composite fibre, fixed to the masonry surface using epoxy increase the shear strength of unreinforced masonry walls (see Figure 61 and Figure 62)
 - **Steel exterior or internal elements:** the in-plane flexural capacity of unreinforced masonry piers governed by rocking can be improved by adding steel vertical elements grouted or cemented into drilled cores or cuts, or externally fixed to the piers. See (see Figure 61 and Figure 62).
 - **Exterior or internal axial post tensioning:** the in-plane and shear capacity can be increased by bonded or unbonded post-tensioning within a drilled core or externally fixed to the piers. (see Figure 61 and Figure 62).
 - **Enlarging openings:** enlarging the openings in order to change the pier slenderness and to induce ductile rocking mechanism instead of brittle failure modes.
 - **Infilling of wall openings.**

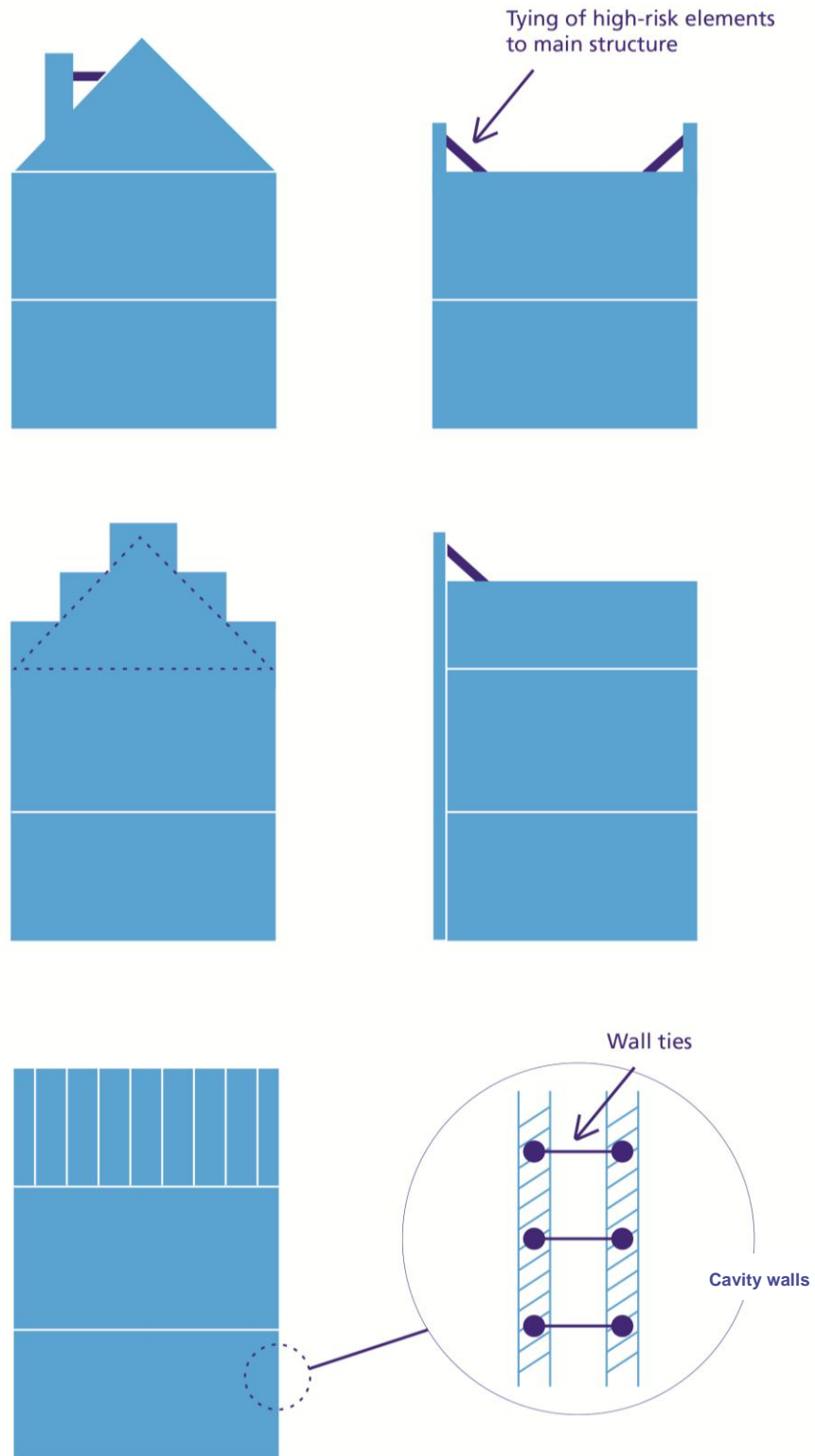

Figure 59 Tying / removing high-risk elements (chimneys, parapets, ornaments and cavity walls).

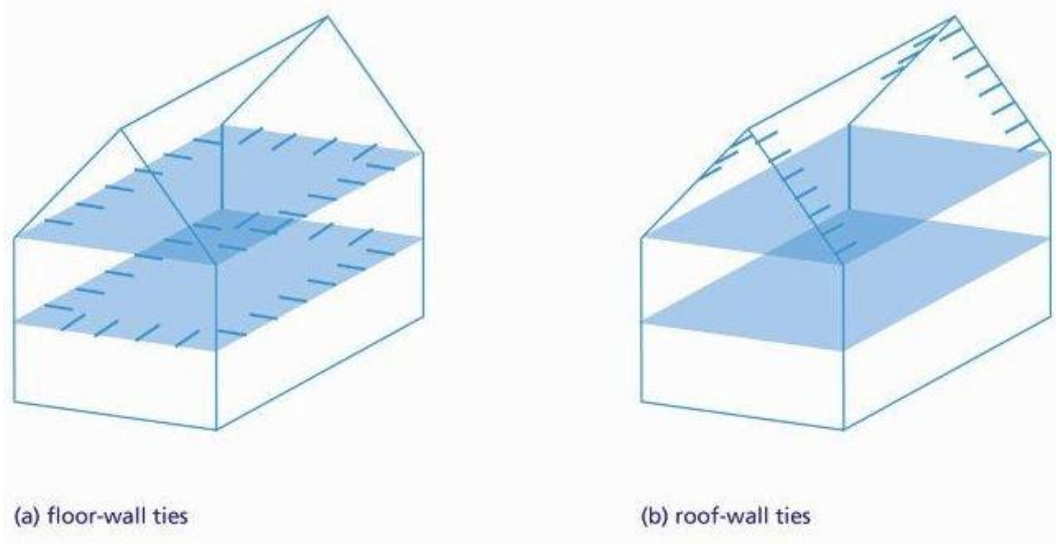

Figure 60 Connections between walls, floors and roof.

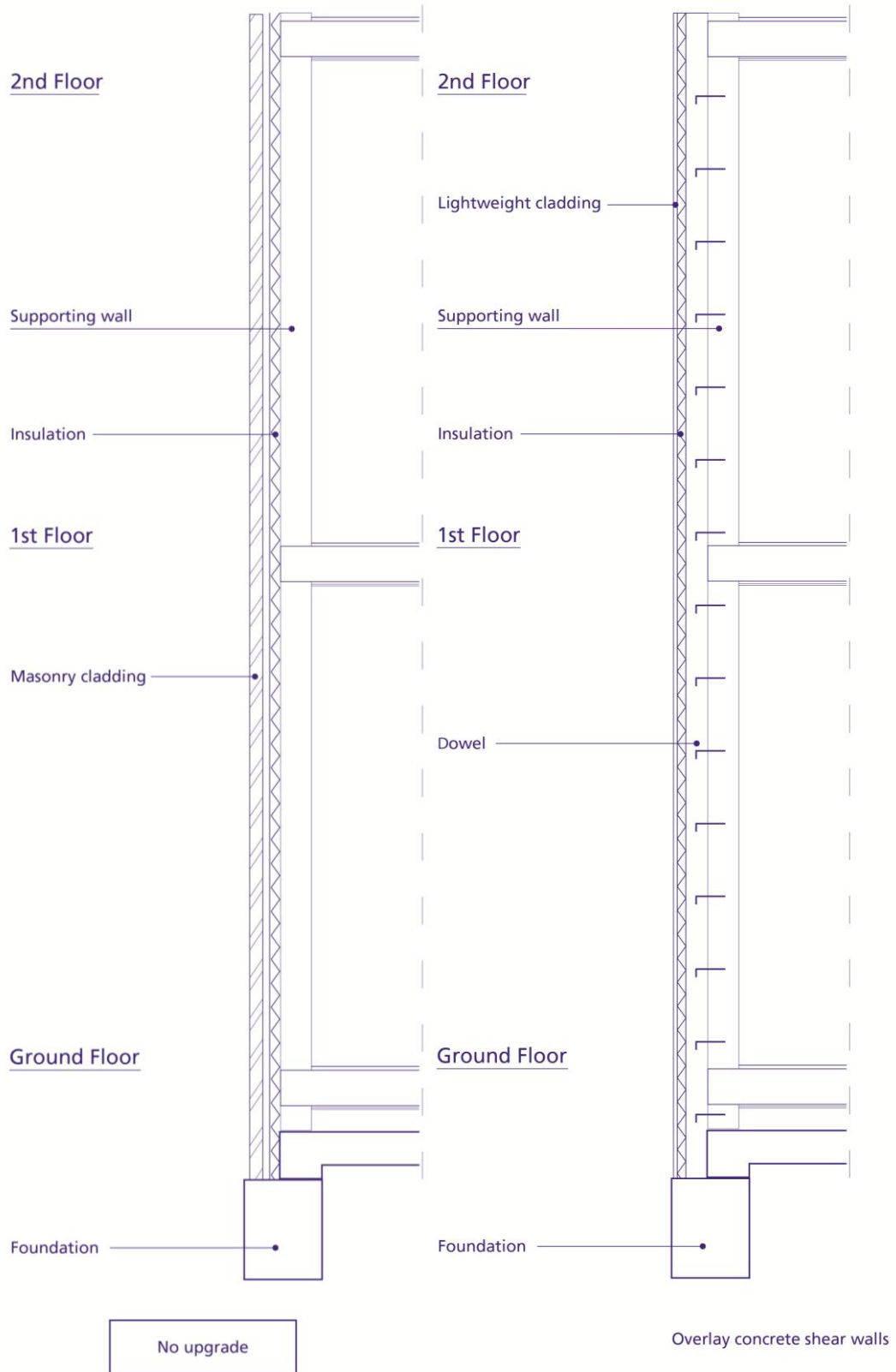

Figure 61-1 Cavity wall No upgrade.

Figure 61-2a Cavity wall Overlay concrete shear wall.

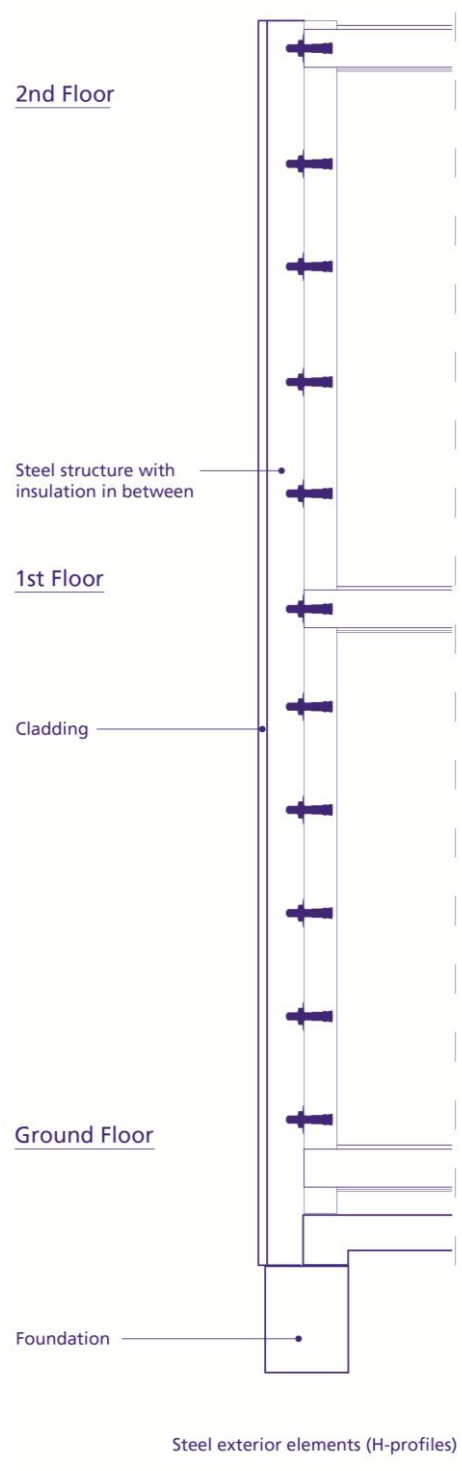
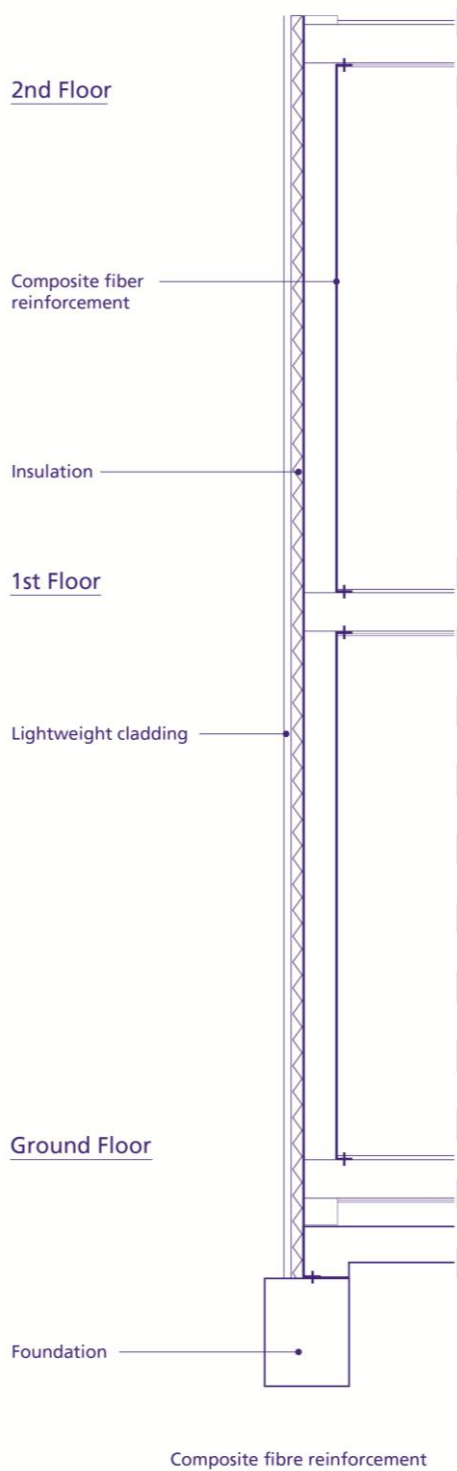

Figure 61-2b Cavity wall
Composite fibre reinforcement.

Figure 61-2c Cavity wall
Steel exterior reinforcement.

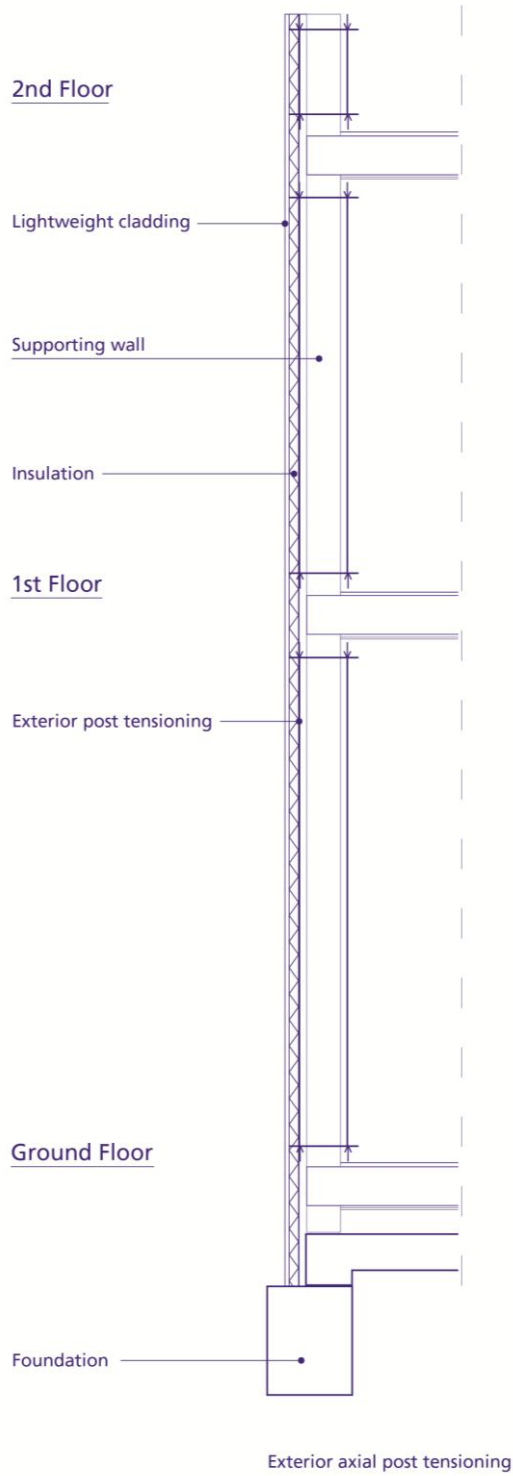

Figure 61-2d Cavity wall
External axial post tensioning.

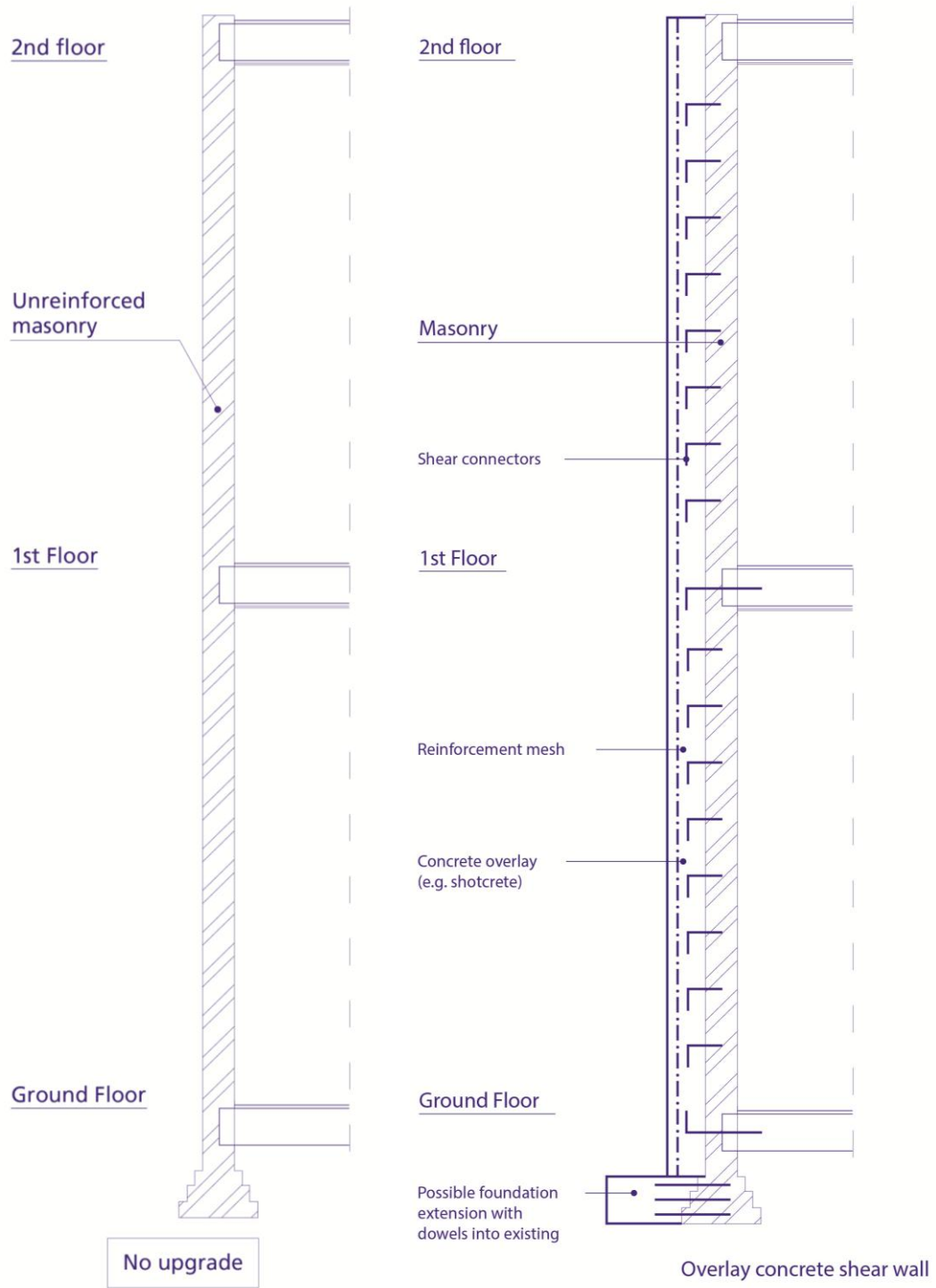

Figure 62-1 Normal wall No upgrade.

Figure 62-2a Normal wall Overlay concrete shear wall.

C

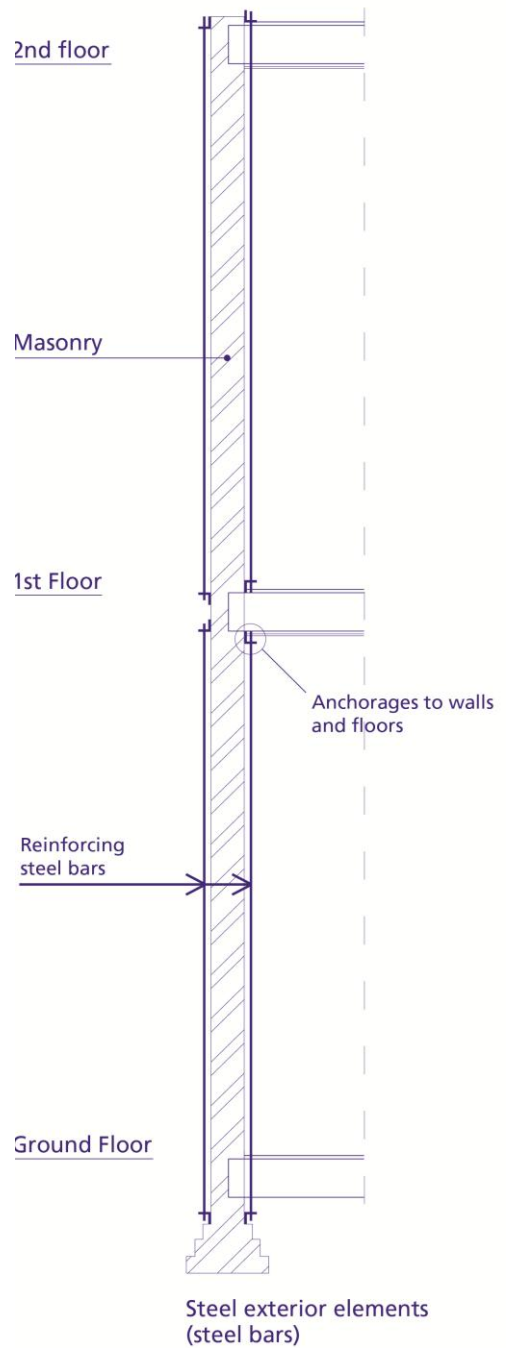
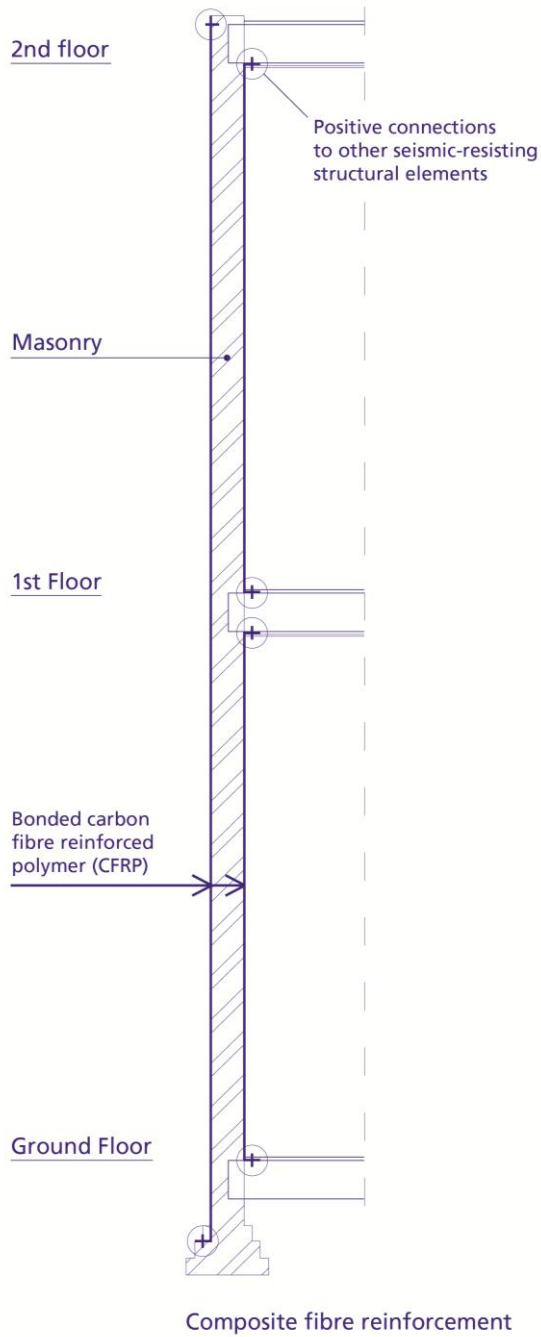

Figure 62-2b Normal wall
Composite fibre reinforcement.

Figure 62-2c Normal wall
External axial post tensioning.

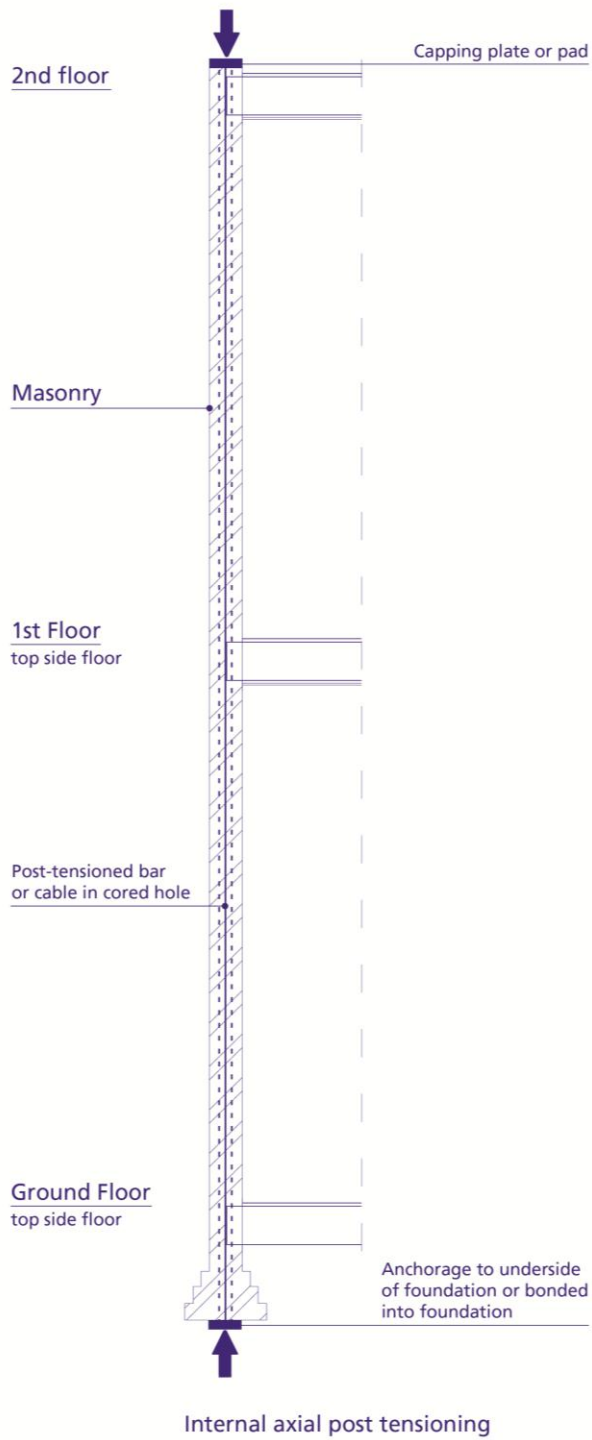

Figure 62-2d Normal wall
External axial post tensioning.

- **Wall out-of-plane structural upgrading:**
 - **Overlay concrete shear walls:** overlay concrete shear walls can be used to improve out-of-plane strength. This works as a composite masonry and concrete structure. Often, foundation strengthening is needed to allow for additional mass.
 - **Composite fibre reinforcement:** Overlays of composite fibre, fixed to the masonry surface using epoxy increase the out-of-plane flexural capacity of unreinforced masonry walls by increasing the tensile capacity.
 - **Steel exterior or internal elements:** the out-of-plane flexural capacity of unreinforced masonry piers can be improved by adding steel vertical elements grouted or cemented into drilled cores or cuts, or externally fixed to the piers.
 - **External or internal axial post tensioning:** the out-of-plane flexural capacity can be increased by bonded or un-bonded post-tensioning within a drilled core or externally fixed to the piers.
 - **Mullion supports:** mullion supports decrease the span of the wall and decrease slenderness of the unreinforced masonry wall.

B3 Unconventional Measures

Since the 1960s, structural upgrading measures have been introduced using specific devices to improve the seismic performance

- **Seismic isolation:** The building is isolated from seismic action at its base by mounting it on isolators. Forces and accelerations are decreased significantly by shifting the building period and increasing the damping. For existing buildings, installation is difficult and this option will be considered if either the building or contents are mission critical and must stay operational, or whether these are particularly valuable. This approach may be applicable for historic buildings; governmental buildings and hospitals (see Figure 58).
- **Yielding elements:** supplementary energy dissipation in terms of yielding steel or aluminium elements is discussed in several research papers and might be effective when piers fail in rocking failure. Application is still scarce, but could be an efficient and cost effective approach.

Appendix C

Typical Building Typology Photographs

Table 6 Typicals - Characteristics









Nr	Typology		Image	Foundations	Ground Floor	1st Floor	Attic	Walls	Party Walls
1	T1	Terraced		Piles	Concrete	Concrete	Concrete	Cavity	Cavity
2	T2a	Semi-detached		Strip Footing	Timber	Timber	Timber	Cavity	Solid
3	T2b	Semi-detached		Strip Footing	Concrete	Concrete	Concrete	Cavity	Solid
4	T3a	Detached		Strip Footing	Timber	-	Timber	Solid	-
5	T3b	Detached		Strip Footing	Concrete	-	Concrete	Cavity	-
6	T4	Labourer's cottage		Strip Footing	Timber	-	Timber	Solid	-
7	T5	Mansion		Strip Footing	Timber	-	Timber	Solid	-
8	T6	Large masonry villa		Strip Footing	Timber	Timber	Timber	Solid	-

Table 7 Terraced - Sub-typologies



Nr	Sub-typology		Image	Foundations	Ground Floor	1st Floor	Attic Floor	Walls	Party Walls
1	T1	Terraced		Stepped brockwork	Timber	Timber	Timber	Solid	Solid
2	T1	Terraced		Stepped brockwork	Timber	Timber	Timber	Solid	Cavity
3	T1	Terraced		Strip footing	Concrete	Concrete	Concrete	Solid	Cavity
4	T1	Terraced		Strip footing	Concrete	Concrete	Concrete	Cavity	Cavity
5	T1	Terraced		Strip footing	Timber	Concrete	Timber	Solid	Cavity
6	T1	Terraced		Strip footing	Timber	Concrete	Timber	Cavity	Cavity
7	T1	Terraced		Strip footing	Timber	Timber	Timber	Solid	Cavity
8	T1	Terraced		Strip footing	Timber	Timber	Timber	Cavity	Cavity
9	T1	Terraced		Wooden piles	Timber	Timber	Timber	Solid	Solid
10	T1	Terraced		Wooden piles	Timber	Timber	Timber	Solid	Cavity
11	T1	Terraced		Wooden piles	Timber	Timber	Timber	Cavity	Solid
12	T1	Terraced		Wooden piles	Timber	Timber	Timber	Cavity	Cavity
13	T1	Terraced		Modern piles	Concrete	Concrete	Concrete	Solid	Solid
14	T1	Terraced		Modern piles	Concrete	Concrete	Concrete	Solid	Cavity
15	T1	Terraced		Modern piles	Concrete	Concrete	Concrete	Cavity	Solid
16	T1	Terraced		Modern piles	Concrete	Concrete	Concrete	Cavity	Cavity

Table 8 Semi-detached - sub-typologies

Nr	Sub-typology		Image	Foundations	Ground Floor	1st Floor	Attic Floor	Party Walls	Façade Walls
1	T2	Semi-detached		Stepped brockwork	Timber	Timber	Timber	Solid	Solid
2	T2a	Semi-detached		Stepped brockwork	Timber	Timber	Timber	Solid	Cavity
3	T2b	Semi-detached		Strip footing	Concrete	Concrete	Concrete	Solid	Cavity
4	T2	Semi-detached		Strip footing	Concrete	Concrete	Concrete	Cavity	Cavity
5	T2	Semi-detached		Strip footing	Concrete	Concrete	Timber	Solid	Cavity
6	T2	Semi-detached		Strip footing	Concrete	Concrete	Timber	Cavity	Cavity
7	T2	Semi-detached		Strip footing	Timber	Concrete	Timber	Solid	Cavity
8	T2	Semi-detached		Strip footing	Timber	Concrete	Timber	Cavity	Cavity
9	T2	Semi-detached		Strip footing	Timber	Timber	Timber	Solid	Cavity
10	T2	Semi-detached		Strip footing	Timber	Timber	Timber	Cavity	Cavity
11	T2	Semi-detached		Wooden piles	Timber	Timber	Timber	Solid	Solid
12	T2	Semi-detached		Wooden piles	Timber	Timber	Timber	Solid	Cavity
13	T2	Semi-detached		Wooden piles	Timber	Timber	Timber	Cavity	Solid
14	T2	Semi-detached		Wooden piles	Timber	Timber	Timber	Cavity	Cavity
15	T2	Semi-detached		Modern piles	Concrete	Concrete	Concrete	Solid	Solid
16	T2	Semi-detached		Modern piles	Concrete	Concrete	Concrete	Solid	Cavity
17	T2	Semi-detached		Modern piles	Concrete	Concrete	Concrete	Cavity	Solid
18	T2	Semi-detached		Modern piles	Concrete	Concrete	Concrete	Cavity	Cavity

Appendix D

Glossary

D1 Glossary

General

- Accelerogram:** A record of acceleration versus time during an earthquake obtained from an accelerometer.
- Accelerometer:** An instrument used to measure ground accelerations caused by an earthquake.
- Aleatory Variability:** This is the natural randomness in a process. For discrete variables, the randomness is parameterised by the probability of each possible value. For continuous variables, the randomness is parameterised by the probability density function.
- Attenuation:** Decrease in seismic motions with respect to distance from the epicentre, depending on both geometric spreading and the damping characteristics of the ground.
- Capacity:** The amount of force or deformation an element or component is capable of sustaining.
- Casualty classification:** Severity levels (SL) are defined as:
 SL 1: injuries that require basic medical aid and could be administered by paraprofessionals. They would need bandages or observations;
 SL 2: injuries requiring a greater level of medical care and use of medical technology (x-rays or surgery) but not expected to progress to a life threatening status;
 SL 3: injuries posing immediate life threatening conditions if not adequately treated; and
 SL 4: instantaneously killed or mortally injured.
- Collapse:** For a given structure type, more than one failure mechanism can be identified as leading to collapse of different extents or parts of the total building envelope. Earthquake induced collapse of a masonry building is defined as failure of one or more exterior walls resulting in partial or complete failure of the roof and/or one or more floors. For an in-situ concrete building collapse is defined as failure of one or more floors or complete failure of part of the framed structure. For a steel frame building collapse refers to failure of the roof or one or more floors due to instability of the frame. For a multi-storey building, collapse refers to more than 50% volume reduction resulting from failure of the roof and one or more floors of the building.
- Damage:** Non-rehabilitating structural or aesthetic change following a seismic event.
- Damage state classification:** DS0: no damage;
 DS1: negligible to slight damage (no structural damage, slight non-structural damage);
 DS 2: moderate damage (slight structural damage, moderate non-structural damage);
 DS 3: substantial to heavy damage (moderate structural damage, heavy non-structural damage);
 DS 4: very heavy damage (heavy structural damage,

	very heavy non-structural damage); and DS 5: destruction (very heavy structural damage).
Damping:	A measure of energy dissipation. Damping in a structure is typically defined in terms of percent of critical damping.
Deformation:	The amount by which an element or component changes from its initial shape.
Design Earthquake:	A theoretical earthquake against which the building will be assessed.
Design Life:	The period of time during which a facility or component is expected to perform according to the technical specifications to which it was produced.
Eurocode (EC):	Standard suite of structural design guidance adopted across the European Union.
Focal Depth:	The conceptual "depth" of an earthquake. If determined from high-frequency arrival-time data, this represents the depth of rupture initiation (the "hypocentre" depth).
Focus:	See Hypocentre.
Free Field Ground Motion:	The motion that would occur at a given point on the ground owing to an earthquake if vibratory characteristics were not affected by structures and facilities.
Frequency of Exceedance:	The frequency at which a specified level of seismic hazard will be exceeded at a site or in a region within a specified time interval.
Geometric Mean:	This is a type of mean or average, which indicates the central tendency or typical value of a set of numbers. The geometric mean of two numbers is given by the root square of the product of the numbers. Many GMPEs are derived for the Geometric Mean.
Ground Motion Prediction Equation (GMPE):	Also known as "attenuation relationships", these correlations estimate the ground motion due to an earthquake of a given magnitude at a specific distance. It can also consider the tectonic regime, fault characteristics, focal depth and soil conditions.
Hypocentre:	Point in the earth where the seismic disturbance (earthquake) originates. Also known as focus.
In-Plane:	In the direction parallel to the plane created by the element's largest dimensions.
KNMI:	Koninklijk Nederlands Meteorologisch Instituut.
Large Seismic Event:	A seismic event of M5.5 or greater.
Longitudinal Direction:	Direction which is parallel to the plane created by the largest two dimensions of an element.
Magnitude:	A logarithmic scale of earthquake size, based on seismograph records. A number of different magnitude scales exist, including Richter or local (M_L), surface wave (M_S), body wave (m_b) and duration (M_d) magnitudes. The most common magnitude scale now used is moment magnitude (M_W), which measures the size of earthquakes in terms of the energy released.
Masonry Pier:	Vertical element between openings in a masonry wall.

Modal Response:	An analytical tool for assessing the dynamic response of a structure's response to vibration (typically taking into account the structures mass and stiffness).
Mode:	The specific behaviour of a structure under a defined frequency.
NPR:	Nationale Praktijkrichtlijn (Dutch national codes of practice).
NEN:	Nederlands Normalisatie-Instituut
NAM:	Nederlandse Aardolie Maatschappij
Non-Linear Analysis :	Analysis which accounts for deformations in an element or yielding of the material.
Out-of-Plane:	In the direction perpendicular to the plane created by the element's largest dimensions.
Peak Ground Acceleration (PGA):	The maximum absolute value of ground acceleration displayed on an accelerogram; the greatest ground acceleration produced by an earthquake at a site.
Probabilistic Seismic Hazard Analysis (PSHA):	An assessment of the seismic hazard at a given site, taking into account in a probabilistic framework the seismic sources in the area, how often earthquakes of different magnitudes are produced by those sources, what the expected shaking at the site would be under different magnitudes (see “attenuation”) and all the uncertainties in each of these aspects.
Reference Period:	A period of time over which a probability calculation is made; for example a reference period for seismic hazard may be the design life of the structure.
Response Spectrum:	The plot of structural period against peak response (absolute acceleration, relative velocity or relative displacement) of an elastic, single degree of freedom system, for a specified earthquake ground motion and percentage of critical damping. Relative motions are measured with respect to the ground.
Return Period:	The inverse of the annual frequency of occurrence. For example, the ground motion which has a 1% chance of being exceeded at a given point each year has a return period of (1/0.01) or 100 years.
Seismic Action:	See Base Shear.
Seismic Hazard:	The frequency with which a specified level of ground motion (for instance 20% of ground acceleration) is exceeded during a specified period of time.
Seismic Response:	The behaviour of the structure with regards to the base shear and modal response.
Seismicity:	The frequency and size of earthquake activity of an area.
Serviceability Limit State (SLS):	The combination of loads which relate to the assessment of the building for the functioning or appearance of the structure or comfort of people.
Site Response:	The behaviour of a rock or soil column at a site under a prescribed ground motion.
TNO:	Nederlandse Organisatie voor Toegepast Natuurwetenschappelijk Onderzoek (Dutch organisation for applied scientific research).
Transverse Direction:	Direction which is perpendicular to the plane created by

	the largest two dimensions of the element.
Ultimate Limit State (ULS):	The combination of loads which relate to the assessment of the building for the safety of people, structure or contents.
Uniform Hazard Response Spectrum (UHRS):	This is a multi-parameter description of ground motion that can be generated from a probabilistic seismic hazard assessment. It is composed of a number of points which each have an equal likelihood of being exceeded in a given time period.
Unreinforced Masonry (URM):	Masonry which does not contain any additional element to strengthen the masonry beyond masonry units and mortar.
Unusable:	A damage state whereby a building cannot be used for its primary function – e.g. for residences, the building is not safe to occupy and for hospitals the facilities cannot be used for post-earthquake treatment.
Viscous Damping:	Dissipation of seismic energy considered to be proportional to velocities in the structure. Commonly used as a mathematical model to represent sources of energy dissipation that are not explicitly accounted for in the modelling of structural elements, such as cracking in partitions or radiation energy into the soil.
Wall Ties:	Objects which connect one leaf of masonry to another object (typically the internal masonry leaf).

Eurocode 8

Capacity Assessment Method:	Design method in which elements of the structural system are chosen and suitably designed and detailed for energy dissipation under severe deformations while all other structural elements are provided with sufficient strength so that the chosen means of energy dissipation can be maintained.
Damage Limitation (DL):	Structure is only lightly damaged, with structural elements prevented from significant yielding and retaining their strength and stiffness properties. Non-structural components, such as partitions and infills, may show distributed cracking, but the damage could be economically repaired. Permanent drifts are negligible. The structure does not need any repair measures.
Elastic Response:	Behaviour of the structure when subject to the design spectrum for elastic analysis.
Lateral Force Method:	A simplified linear-elastic analysis method which applies a horizontal load to each storey. This method is only applicable to buildings which are regular in elevation and is within a limiting fundamental period.
Modal Response Spectrum Analysis:	A linear-elastic analysis method which applies lateral load depending on the combined modal responses of the specific structure. This method is applicable to buildings which do not meet the Lateral Force Method criteria.
Near Collapse (NC):	Structure is heavily damaged, with low residual lateral strength and stiffness, although vertical elements are still capable of sustaining vertical loads. Most non-structural

components have collapsed. Large permanent drifts are present. The structure is near collapse and would probably not survive another earthquake, even of moderate intensity.

Non-structural Element: Architectural, mechanical or electrical element, system and component which, whether due to lack of strength or to the way it is connected to the structure, is not considered in the seismic design as load carrying element.

Significant Damage (SD): Structure is significantly damaged, with some residual lateral strength and stiffness, and vertical elements are capable of sustaining vertical loads. Non-structural components are damaged, although partitions and infills have not failed out-of-plane. Moderate permanent drifts are present. The structure can sustain after-shocks of moderate intensity. The structure is likely to be uneconomic to repair.

ASCE 41-13

Acceptance criteria: Limiting values of properties such as drift, strength demand and inelastic deformation used to determine the acceptability of a component at a given performance level (See also performance levels).

Collapse Prevention (S-5): Post-earthquake damage state in which the building is on the verge of partial or total collapse. Substantial damage to the structure has occurred, potentially including significant degradation in the stiffness and strength of the lateral-force-resisting system, large permanent lateral deformation of the structure, and - to a more limited extent - degradation in vertical-load-carrying capacity. However, all significant components of the gravity-load-resisting system must continue to carry their gravity loads. Significant risk of injury due to falling hazards from structural debris might exist. The structure might not be technically practical to repair and is not safe for re-occupancy, as aftershock activity could induce collapse.

Damage Control (S-2): Midway point between Life Safety and Immediate Occupancy. It is intended to provide a structure with a greater reliability of resisting collapse and being less damaged than a typical structure, but not to the extent required of facility structure designed to meet the Immediate Occupancy performance level.

Demand: The amount of force or deformation imposed on an element or component.

Diaphragm: A horizontal (or nearly horizontal) structural element used to transfer inertial lateral forces to vertical elements of the lateral-force-resisting system.

Drift: Horizontal deflection at the top of the storey relative to the bottom of the storey.

Flexible Diaphragm: A diaphragm with horizontal deformation along its length twice or more than twice the average storey drift.

Fundamental Period: The natural period of the building in the direction under consideration which has the greatest mass participation.

- Immediate Occupancy (S-1):** Post-earthquake damage state in which only very limited structural damage has occurred. The basic vertical- and lateral-force-resisting systems of the building retain nearly all of their pre-earthquake strength and stiffness. The risk of life-threatening injury as a result of structural damage is very low, and although some minor structural repairs might be appropriate, these would generally not be required prior to re-occupancy. Continued use of the building will not be limited by its structural condition, but might be limited by damage or disruption to non-structural elements of the building, furnishings, or equipment and availability of external utility services.
- Life Safety (S-3):** Post-earthquake damage state in which significant damage to the structure has occurred but some margin against either partial or total structural collapse remains. Some structural elements and components are severely damaged but this has not resulted in large falling debris hazards, either inside or outside the building. Injuries might occur during the earthquake; however, the overall risk of life-threatening injury as a result of structural damage is expected to be low. It should be possible to repair the structure; however, for economic reasons this might not be practical. Although the damaged structure is not an imminent collapse risk, it would be prudent to implement structural repairs or install temporary bracing prior to re-occupancy.
- Limited Safety (S-4):** Midway point between Life Safety and Collapse Prevention. It is intended to provide a structure with a greater reliability of resisting collapse than a structure that only meets the collapse prevention performance, but not to the full level of safety that the life safety performance level would imply.
- Load Duration:** The period of continuous application of a given load, or the cumulative period of intermittent applications of load.
- Probability of Exceedance:** The probability that a specified level of ground motion or specified social or economic consequences of earthquakes will be exceeded at a site or in a region during a specified period of time.
- Rigid Diaphragm:** A diaphragm with horizontal deformation along its length less than half the average storey drift.
- Shear Wall:** A wall that resists lateral forces applied parallel with its plane. Also known as an in-plane wall.
- Stiff Diaphragm:** A diaphragm that is neither flexible nor rigid.
- Target Displacement:** An estimate of the maximum expected displacement of the roof of a building calculated for the design earthquake.